



Andor iQ3 USER GUIDE

Last Update December 2013

1 - WELCOME	7
1.1 Introduction	8
1.2 System Requirements	10
1.3 Access to Software and Installation	12
1.4 How to Use this Guide	14
1.5 Andor ImageDisk Technology	16
1.6 Related Andor Systems Products	17
1.7 Software Development Kits (SDK).....	19
2 - THE USER INTERFACE	20
2.1 User Management and Logon Procedure	21
2.2 Starting iQ.....	26
2.3 Concepts in Andor iQ.....	28
2.4 Supported Image File Formats.....	41
2.5 The iQ Control Window.....	42
2.6 Function Tabs	57
2.7 The Image Window	68
2.8 The Image Window Menus	73
2.9 The Image Navigator.....	88
2.10 The Image Toolbar	92
3 - CALIBRATION AND ALIGNMENT TOOLS	103
3.1 Wizards - Help Setting up Your Imaging System.....	104
3.2 Calibrate Your System.....	107
3.3 Differential Spinning Disk (DSD) Calibration Wizard	114
3.4 Dual Camera Image Alignment.....	121
3.5 Stage Alignment.....	129
3.6 FRAPPA Devices and Calibration	137
4 - ACQUISITION TOOLS	156

Andor iQ USER GUIDE

4.1 Configurations	157
4.2 Channels and the Channel Wizard	171
4.3 Scans and the Scan Wizard.....	176
4.4 nD Protocol Tree Actions - Insert, Delete and Edit	213
4.5 Protocols - basics.....	226
4.6 Flexible Protocol Patterns	233
4.7 Multi-camera acquisition	242
4.8 Precision Control Unit (PCU), Triggers and Events	251
5 - ANALYSIS + VISUALIZATION	260
5.1 Image Contrast and LUTs	261
5.2 The Online Graph.....	267
5.3 Through-Series Analysis	269
5.4 RGB Analysis and Co-Localization.....	275
5.5 Analysis Options	284
5.6 The Movie Editor	292
5.7 The Spot Function	297
5.8 Kymograph	335
5.9 Orthogonal Slice View	343
5.10 The Strip View Tool.....	346
5.11 The FastMIP and 4D View.....	349
5.12 Montage View	352
5.13 FRAP Analysis	357
6 - PROCESSING TOOLS.....	363
6.1 Process – Episodic Average.....	364
6.2 Mask Wizard.....	367
6.3 Field Split	368
6.4 Flip/Rotate.....	378
6.5 Image Filter	379
6.6 Rolling Ball Filter	383

Andor iQ USER GUIDE

6.7 Threshold Image	386
6.8 ClearView - Deconvolution	387
6.9 Best Z	389
6.10 The Image Math Process	393
6.11 Ratio Image	401
6.12 Image-Image Math Plugin	419
6.13 Dual ImageDisk Plugin	430
6.14 Plug-In Registration and Access	432
6.15 RGB Merge	433
6.16 Photo-bleach Compensation	436
APPENDIX 1 - INSTALLING THE SOFTWARE	440
A1.1 Installation of Sentinel Drivers	441
A1.2 Troubleshooting Dongle Issues	444
A1.3 Initialising a Dongle for Additional Products	447
A1.4 Install the Latest Windows NT Service Pack	448
A1.5 Installing the Windows Scripting Host	449
A1.6 Installing your Andor Software	450
APPENDIX 2 - CONFIGURATION MANAGER	451
A2.1 The Configuration Manager	452
APPENDIX 3 – HARDWARE DEVICE SETUP	466
A3.1 Hardware Devices	467
A3.2 Andor iXon	469
A3.3 DIO and DAC Card Installation for PCU and FLZ	485
A3.4 The Sutter Filter Devices	490
A3.5 The Prior Motorized XYZ Stage	496
A3.6 Ludl XYZ Stages and Filter Wheel	500
A3.7 ASI XYZ Stages	508
A3.8 Thor Labs LEDD1 controller	511
A3.9 CoolLED – PE2 and PE100 LED illuminators	514

Andor iQ USER GUIDE

A3.10 Andor Differential Spinning Disk (DSD)	517
A3.11 Metal Halide Source (Prior LumenPro)	520
A3.12 Andor PZT-X00 Piezo Stage control	521
A3.13 Generic TTL control from Andor iQ	523
A3.14 Physik Instrumente USB stage controllers	527
A3.15 Andor Laser Combiner (ALC)	530
A3.16 Virtual Camera	537
A3.17 ‘Rotr’, Andor Filter Wheel	543
A3.18 Yokogawa CSU	548
A3.19 Andor Mosaic Device	560
APPENDIX 4 – IMAGE METADATA	576
A4.1 iQ 1.X Image Headers and Metadata	577
APPENDIX 5 – HOW TO DOCUMENTS	602
A5.1. How to Set Up a Channel	603
A5.2. How to Set Up a Multi-field Scan	605
A5.3. How to Set Up a Z Series Scan	607
A5.4. How to Set Up a Prototype Protocol	608
A5.5. How to Change the Sampling Rate on the Fly	609
A5.6. How to Use “Load a Protocol”	611
A5.7. How to On-Line Chart During Acquisition	612
A5.8. How to Open an Image (TIFF)	614
A5.9. How to Import Multi-dimensional Images Part 1	615
A5.10. How to Import Multi-dimensional Images Part 2	616
A5.11. How to Adjust the File Size Limit	617
A5.12. Saving Multiple Images from the ImageDisk	618
A5.13. How to Save JPEG or BMP Images	620
A5.14. How to Copy Images to the Clipboard	622
A5.15. How to Share and Backup Protocols	623
A5.16. Setting FLZ - Frame Transfer (FT) Blanking	625

Andor iQ USER GUIDE

A5.17. How to Configure Triggered Looping with FLZ	627
A5.18. How to Troubleshoot DSD Calibration.....	632
A5.19. How to Setup MicroPoint for Uncaging.....	637
A5.20. How to Create a Protocol Template	639
A5.21. Configure iQ with Lumencor Light Engine	645
A5.22. Configure iQ with Lumen Dynamics X-CITE XLED1.....	652
A5.23. Image Registration and creating calibration files for single channel images in the Field Split plug-in.....	661
A5.24. Image Registration and creating calibration files for dual channel images in the Field Split plug-in	667
A5.25 “XD and FLIM” Andor iQ and Lambert LIFA Systems Interaction	672
A5.26 Montage/Stitching using FIJI	689
A5.27. Importing protocols from other users or older versions of iQ	692



1 - Welcome

1.1 Introduction

Welcome to Andor Technology's scientific imaging software Andor iQ, which is focused on multidimensional image acquisition. iQ provides processing and analysis functions closely associated with acquisition and now partners with Bitplane Imaris as the preferred visualization and analysis platform. Andor iQ has been developed with multi-dimensional live-cell and time-lapse imaging in mind and therefore has many powerful features not found in conventional image acquisition products, but is equally at home capturing data from fixed specimens.

Since iQ can control a wide range of experimental devices, including cameras (EMCCD, Cooled CCD, sCMOS), illumination controls (e.g laser combiners with AOTF, shutters, filter wheels etc.), motorized stages and microscopes, sophisticated acquisition protocols can be easily setup and utilized. The current range of supported devices is listed in section 1.8. Since this range is continually evolving please contact Andor Technology or your local agent to confirm support of new devices.

We are currently developing the **Andor iQ 3** stream of releases. iQ 3 delivers a new user interface called 6D view, as well as the old nD tree view interface. The new 6D view interface is a simplified version of the nD tree view that brings all the settings together in a single tab and offers rapid interaction. iQ 3 also delivers new multi-user management under a single Windows logon. This new feature offers each user a private imageList, as well as private channels, protocols, and scans.

iQ3 also offers the Python interface. The Python IDE is an open source module available free of charge from Andor Technology and it provides a user-programming environment which enables extension of iQ and an enormous resource repository of open source libraries. See www.python.org for more information.

We are delighted that you have decided to use Andor iQ, and hope it will prove both powerful and easy to use.

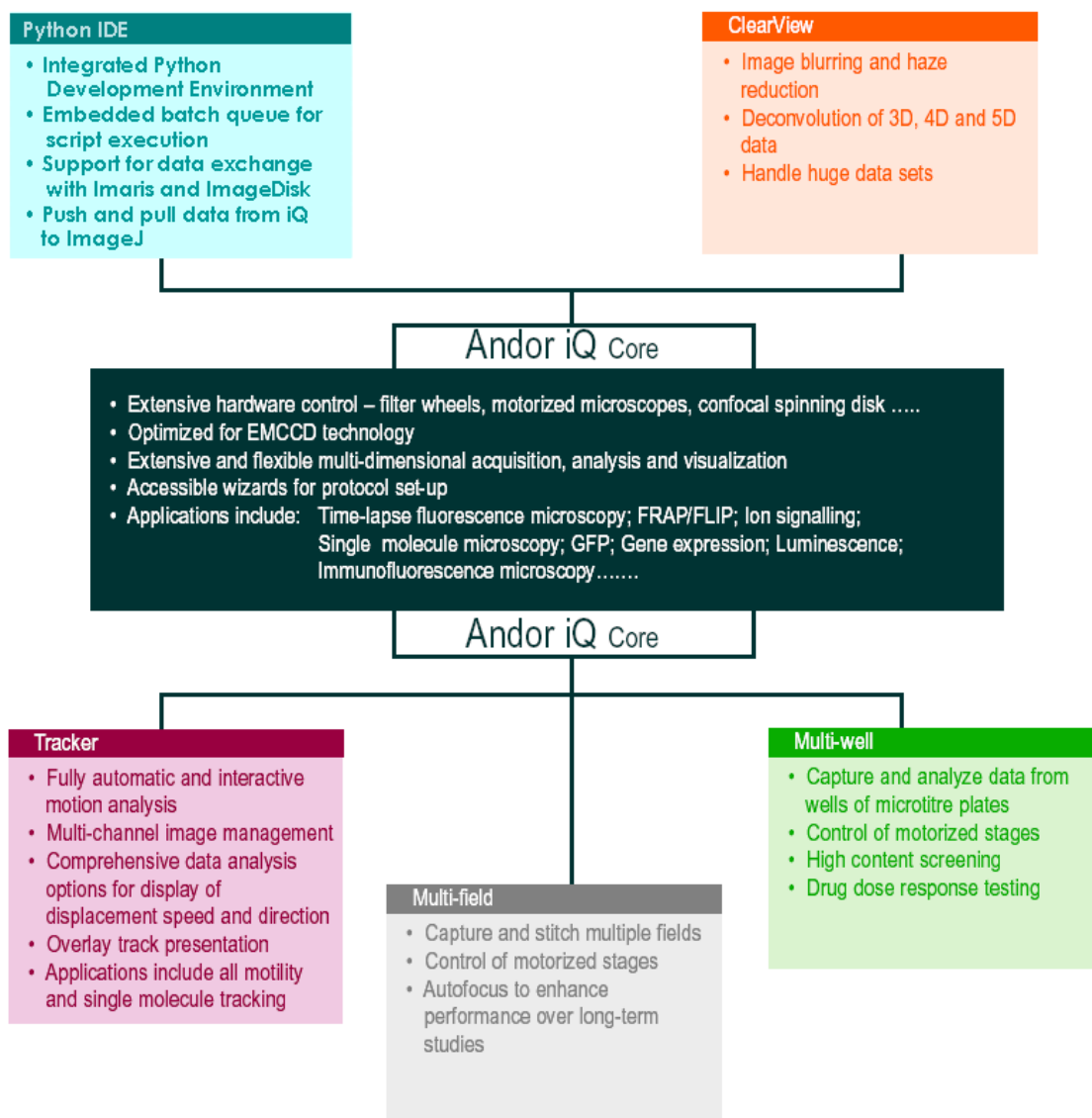

1.2 System Requirements

Andor iQ requires the following minimum computer configuration:

- Minimum Pentium 4 2.8 GHz running Microsoft Windows XP Professional. We recommend the fastest possible PC with multi-core processor, high performance RAM and graphics adapter.
- Minimum RAM 512 MB (2-4 GB recommended).
- Fast hard drive for the operating system with at least 30GB or 30% free space.

Second fast hard drive (e.g. SATA) to make optimal use of ImageDisk. In Andor supplied workstations we provide a pair of SATA hard drives in RAID 0 configuration to ensure sufficient bandwidth for streaming high speed imaging data. This avoids limitations of system RAM or slow-downs due to Windows file swapping.

- Graphics adapter with a minimum of 1280x1024 resolution and 16-bit color, and a suitable display monitor. Andor iQ has been designed to make use of dual monitor systems when provided. We recommend at least a 19" monitor.
- A sensitive CCD or EMCCD camera can be used.
- There must be either a vacant PCI slot for the imaging card (Andor CCI-23 card or CCI-24 (PCI Express) will deliver optimum performance) or alternatively iQ supports USB 2.0 cameras such as the Andor Clara and Luca-series. Some cameras running under Firewire (IEEE1394a, b) are supported (OHCI compliance is required e.g. Texas Instruments chipset required). Other cameras supported by iQ have their own interface boards and these generally require a PCI slot.
- To run the full version of Andor iQ, you will need either a license provided for evaluation or a software protection key (dongle). The Dongle will be of USB type.

We are always pleased to hear from users with information on their applications, feature requests, suggestions and ideas. Please feel free to drop us an email to the

following coordinates.

Questions, Suggestions, Requests and Bug Reports to...

http://www.andor.com/contact_us/support_request/

1.3 Access to Software and Installation

1.3.1 Modularity and Timed Evaluation Settings

Andor iQ is provided as a series of modules, which are available for evaluation and can be downloaded from our FTP site. For more information please contact your local representative or go to http://www.andor.com/contact_us/support_request/.

1.3.2 Dongle and Licensing and Updates

When you purchase iQ modules, you will be supplied with a dongle (key) which plugs into the USB port. The dongle provides licensing for the specific modules purchased. The current components are: Core, FastLZ, Tracker, ClearView, Multi-field and Multi-well Analysis modules. Each Module has a specific dongle code and will be accessible only if you have that license.

If you wish to evaluate any of the iQ modules you can obtain an evaluation license file, which will be setup for 30 days. Andor Evaluation licenses are available by contacting support at http://www.andor.com/contact_us/support_request/.

1.3.3 Download version from FTP or Web

We provide a downloadable version of the software, which can be obtained, with password protection, from a specified Andor ftp: or web site. Once downloaded and installed the iQ software can be activated by the user sending the name of the evaluation computer. Once the id is obtained, we will issue an encrypted license file to run on that computer for a specified time period.

1.3.3 Installation from CD or Download

Insert the Andor Installation CD-ROM and run the program **Start.exe** from the root directory. This will start the installation program which runs side-by-side with an installation Online Help Guide, and will take you through the following steps:

1. Andor Software Protection Key drivers for Windows 2000 Pro / XP Pro (**Appendix**

Andor iQ USER GUIDE

- 1.1). Plug in the dongle when instructed to do so by the installation program.
2. Windows Scripting Host for Image Disk Configurator (**Appendix 1.5**).
3. Andor Bio-imaging Software (**Appendix 1.6**).
4. Configuring your hardware devices (**Chapter 2, Appendix 2 and 3**).
5. Start using the software (**Section 1.4, Chapters 2-6, How To Documents**).

For a detailed description of the installation procedure, please refer to **Appendix 1**. If you need further help, our technical support team will be glad to assist. To report problems please go to http://www.andor.com/contact_us/support_request/. Or if you prefer contact your local supplier who will then liaise with us directly.

If you are installing from a download then simply unzip the file you download and then run (double click) on the self-extracting file that is unzipped with the extension “**exe**”. Then follow on-screen instructions. The installation will provide Andor camera drivers automatically, but third party camera drivers need to be ordered separately and have a separate license.

iQ will need to reboot after installation to allow Windows® to load and initialize the drivers.

1.4 How to Use this Guide

We recommend you use this guide as your primary local help. The iQ Help menu will launch an Adobe Acrobat® view of this document which can be navigated by bookmarks that allow you to drill down into the specific sections you need.

We have tried to produce a useful text, but please feel free to suggest improvements. We suggest you read chapter 2 of this guide or there is an alternative iQ Quick Start Guide (stored in location C:\Program Files\Andor Bioimaging\Help\) especially aimed at analysis.

Before you start imaging with iQ please refer to chapters 3 and 4. Finally when you want to Analyze, Process or Visualize your data then refer the relevant sections. As aides memoires or quick reminders, we have provided some “How To” documents following Appendix 4. These provide very brief step by step guides to achieving certain goal like creating a Channel or a Protocol, loading or saving an image in various formats.

The user guide is arranged as follows:

Chapter 1 provides useful information on product access, overview of installation, use of the user guide, imagedisk technology and some notes about other related software and hardware products.

Chapter 2 delivers an outline of the way iQ can be configured for multi-user scenarios and the roles of administrators and users via the Configuration Manager. It also provides a condensed review of the iQ user interface, windows, dialogs and controls.

Chapter 3 focuses on Wizards which are used for Calibration, Alignment and Setup of instrumentation prior to acquisition of quantitative image data.

Chapter 4 addresses acquisition explaining how Channels, Scans and Protocols are

created and ends with a number of examples from ratio imaging to 4D with FRAPPA actions.

Chapter 5 provides details of how the Analysis and Visualization tools operate and what you can do with them. For more heavy-weight analysis and visualization we recommend Imaris.

Chapter 6 looks at the Processing and Analysis tools in iQ.

Appendices 1 and 2 address Installation and Configuration Manager in more detail.

Appendix 3 includes detailed explanation of some of the hardware device interfaces and their operation in Andor iQ.

Appendix 4 explains how metadata is stored in iQs' multi-dimensional image inside.

How To Documents are just that, recipes on how to achieve a certain goal with Andor iQ.

1.5 Andor ImageDisk Technology

ImageDisk is Andor's image-oriented virtual memory system, which is optimized for the capture and treatment of large image sequences. In Andor iQ the ImageDisk is either shared or held in a separate folder for each Window's User and is located on a Drive specified by the (Local or System) Administrator during system configuration. In this way users' data are isolated from each other, leading to improved security and performance. When you first run iQ, a directory called ImageDisk will be created on the root of specified hard drive. The ImageDisk is non-volatile and so images will be retained between logon sessions.

In general you will obtain best performance if you use physically separate disks for ImageDisk and the operating system (Windows). For optimum overall performance, please refer to **Section 2.3.6**. Data is managed by Andor iQ's Image manager, which allows you to treat multi-dimensional image data as a single data object, similar to a movie clip. Thus you can capture, review, save to disk in TIFF or multi-TIF file format and analyze large image sequences with great ease and at high speed.

On a more technical level ImageDisk provides a virtual memory system, which co-operates with Windows' own virtual memory system. Windows' system is optimized for general computing, so when it comes to images its performance is slow and unpredictable. ImageDisk interrogates Windows prior to virtual memory operations (disk swaps) and ensures that for image operations it maintains free system memory by swapping frames in and out of RAM depending on usage. This ensures that access times are optimized and provides the best performance with the large blocks of data created with multi-dimensional images

1.6 Related Andor Systems Products

We hope you are aware of the range of products offered by Andor Technology for quantitative fluorescence and luminescence imaging. Having entered the field with iQ, these other products might also help in your application of scientific imaging. Further information can be seen on the Andor Web Pages at www.andor.com. Full details will be sent on request.

- **Imaris** – Andor acquired Bitplane AG, the creator of Imaris in December 2009. Imaris is the leading 3D and 4D interactive image visualization and analysis suite for life sciences. Our teams are working together to bring optimum compatibility between our software products and will make announcements as progress is made. In the immediate future please visit the Bitplane website for more information - www.bitplane.com
- **KOMET** - enables you to image and analyze the samples produced using the Single Cell Gel Electrophoresis (Comet) Assay. The Comet Assay is a technique allowing DNA damage in a single cell, to be detected using a fluorescence microscope. Live images from the microscope may be examined directly using a sensitive CCD camera or digital images may be imported from other sources. Operations are initiated from a convenient toolbar and all data is stored in standard spreadsheet format for plotting and statistical analysis. Excel™ Macros are provided to automatically manipulate and view the data.
- **Revolution XD laser spinning disk confocal systems** – Andor is a global distributor of the Yokogawa CSUX dual spinning disk confocal scanner. We integrate the CSUX with Andor and third party-manufactured products to create industry-leading live cell confocal microscopy systems. Our systems provide ultimate sensitivity with extreme flexibility offering confocal, TIRF and FRAPPA and ablation laser microscopy solutions. Visit our website to discover more – www.andor.com/microscopy/
- **Revolution DSD spinning disk structured illumination systems** – Andor

co-exclusively distributes and creates solutions built around the Aurox spinning disk confocal scanner, which is based on the principal of “aperture correlation”. Unlike other white light confocal instruments, DSD provides strong optical sectioning even at low magnifications because out of focus light is sensed via a second optical channel and actively rejected. Laser-free operation makes the system highly cost-effective and provides freedom in choice of excitation and emission filters. Visit our website to find out more.

- **Photonic Instruments Photo-Stimulation Systems** – Andor acquired Photonic Instruments in April 2010. the Photonic products include Mosaic and Micropoint systems which can be used for photo-switching, bleaching, activation and ablation. The products can be configured with Andor and third party products and provide market leading performance and functionality. Please contact us for more information or see the Photonic Instruments web site. www.photonic-instruments.com .

- **Andor Custom Imaging Systems** – Andor will tailor-make a system for quantitative fluorescence or luminescence imaging to meet your requirements. Visit our website to find out more. Solutions for calcium, GFP applications, super-resolutions and more – visit our website for more details.

Andor Systems Division has extensive development facilities and expertise in both fluorescence imaging hardware and software. Custom solutions can be developed.

1.7 Software Development Kits (SDK)

If you have programming effort available and would like to investigate writing your own OCX for a camera or other instrument, SDKs are available on request from Andor. The following SDKs are available and include skeleton OCX and example code provided for Borland Builder and Microsoft Visual C++.

- 1) The new Python IDE is a fast way to extend iQ3 for your specific activities.
- 2) Camera OCX SDK, to allow integration of cameras with Andor iQ.
- 3) Auxiliary Device OCX, to allow integration of instruments with Andor iQ.
- 4) Plug-In dynamic link library (DLL) SDK, to allow creation of specialist tools for image analysis and processing.
- 5) Memory manager SDK, to allow third parties to integrate with Andor's powerful memory manager and gain benefits of ImageDisk technology.
- 6) Andor Laser Combiner control SDK is also available and has been integrated with 3rd party products including LabView and MatLab.
- 7) Photonic Instruments photo-stimulation products can be integrated into third party solutions and an SDK is available on request and agreed terms.

If you are interested please contact us at

http://www.andor.com/contact_us/support_request/ .



2 - The User Interface

2.1 User Management and Logon Procedure

Andor iQ 3.0 introduces the ability to have multiple **Application User Accounts** while still using one common Windows logon. This is now the preferred way of managing multiple users. These accounts control which Configurations a user has access to. In addition, they also provide private Protocols, Channels, Scans and ImageDisks for each user.

By default, iQ Application User Accounts are not switched on and the iQ application starts without prompting the user for credentials just like previous versions.

All user account configuration is performed with the Configuration Manager utility.

When Application User Accounts are switched off, Andor iQ has a 2-level logon procedure. First is the Windows logon and second the iQ logon, both are significant. To setup iQ, logon to Windows as a (local or system) Administrator because this gives you full access. When you logon to iQ you select a “configuration” from a drop down list to initialize the software into the desired configuration. Configurations are created by the Administrator using the Configuration Manager utility (**Section 2.3.1**). The configurations specify which hardware is to be controlled and loads the appropriate software controllers or start iQ in the Analysis mode if no hardware is used.

The Configuration Manager allows the Administrator to control **Global Settings** for **ImageDisk** and **Multi-level User Access (MUA)**. When **MUA is ON**, permissions are varied by Windows User Status. Administrators are able to run the Configuration Manager and change hardware settings, while all users have permission to Run iQ, create, edit and execute instrument control and image acquisition Protocols. If the **ImageDisk** folder is set to **Private** the ImageDisk folder name is based on Windows logon name. This offers data security and privacy, but only if usernames and logons are used correctly. It is important therefore to ensure proper use for this mechanism to function robustly.

If **MUA is OFF**, all users have full access to hardware settings and probably share the same Windows logon. In this case multiple users can be managed in a slightly

different way. If they share a hardware configuration, they can control the same hardware, but under different names, so that their settings and protocols are stored independently. In this case the **ImageDisk is Shared** by all users and so is less secure, but it can work well in multi-user environments when users clean up and save their own data after each session – OR a robust policy of “the ImageDisk will be deleted every night at midnight” with Windows automation routine executing a scheduled clean up.

iQ Application Administrator Account

A special account is available that permits administration access to the Configuration Manager utility as well as the iQ application as a user who has permission to use all configurations. The account username is admin.

Access to Configuration Manager is now restricted to administrators who know the admin password.

Administrator as iQ User

The administrator account also has access to the iQ Application and can use it as a normal user with one difference; all configurations are available to the administrator account.

To log in as Administrator, supply the ‘admin’ username along with the password that has been set in Configuration Manager:



User Accounts

Login

When Application User Accounts are switched on, users must supply their username and password credentials in order to use the iQ application.



Note: clicking Cancel at this point will terminate the application.

Once authenticated, the user is prompted to choose a Configuration to use:

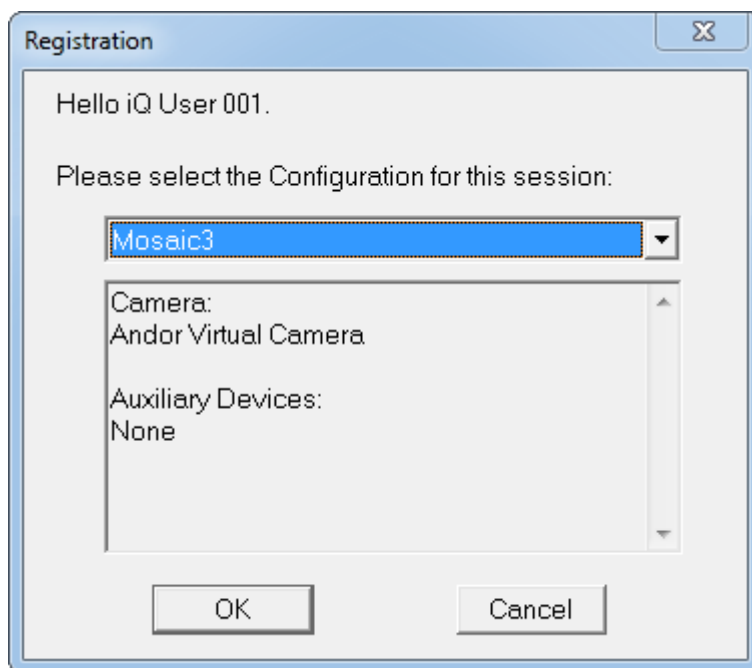

The user can only choose from the configurations that they are authorised to use:

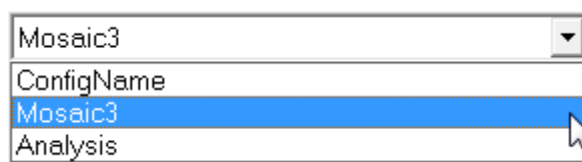

Note: Analysis mode is always available. If a user has no permissions to use any configurations, then iQ will choose that automatically. (Analysis mode was formerly called NoGrab mode).

Once the configuration is chosen, iQ starts up and initialises devices:

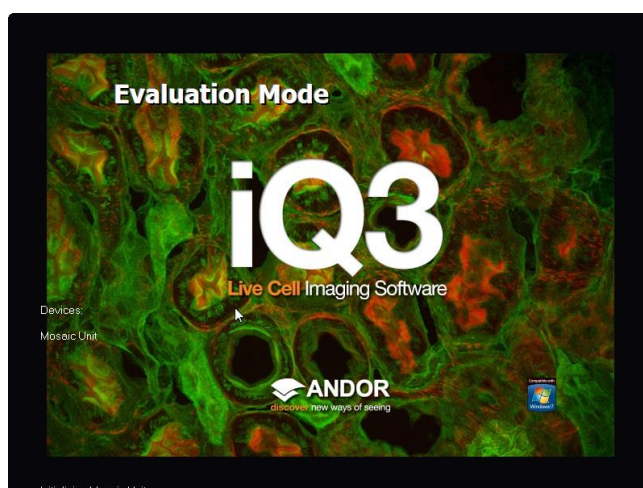

2.1.1 Running iQ While Logged onto a Domain

Some customers may wish to run iQ on a computer while logged onto a remote domain. In this case, Windows grants limited access to certain areas of the local machine. Therefore it is very important that the LOCAL Administrator runs iQ first and sets up the hardware device settings.

By default (in Win2000/XP) all Domain Users are treated as restricted users on the local machine. iQ allows Domain Users full access to the Software e.g. to be able to create, edit and delete Protocols and Channels.

A Note to Administrators:

To find out more about this go to the Windows 2000/XP Start Menu, Settings, Control Panel and Select Users and Passwords and use Windows on-line help. To summarize the Access Levels provided in Andor iQ depend on Local Status and are summarized in the following table:

Access Levels in Andor iQ with MUA ON		
Log On Status	Full + Configuration	Full
Local Admin	Y	
Local User	N	Y
Domain Admin	N	Y
Domain User	N	Y
Domain+Local Admin	N	Y
Domain+Local User	N	Y

2.2 Starting iQ

2.2.1 The iQ 3 6D view User Interface

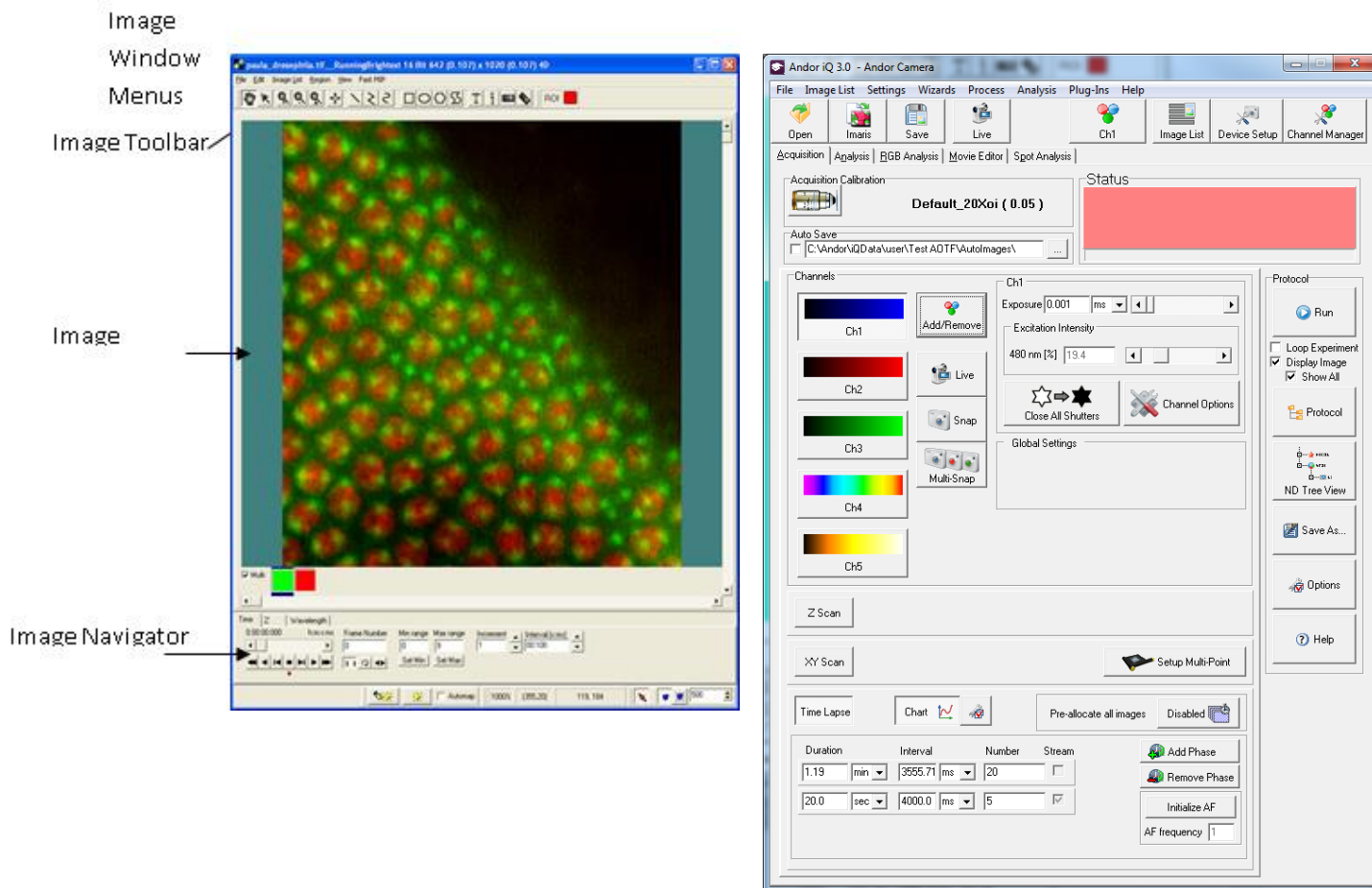

When you have logged onto Windows and iQ as described above, the default User Interface will open in 6D view form. This interface is aimed to simplify the setup of the most common experiments by presenting all the settings together in a single tab. The other form which is shown on the startup is the Image view window. If hardware is specified in the configuration, then the Device Setup window will also be shown. We can switch to the nD tree view form using the ND tree view button.

2.2.2 The iQ 3 nD tree view User Interface

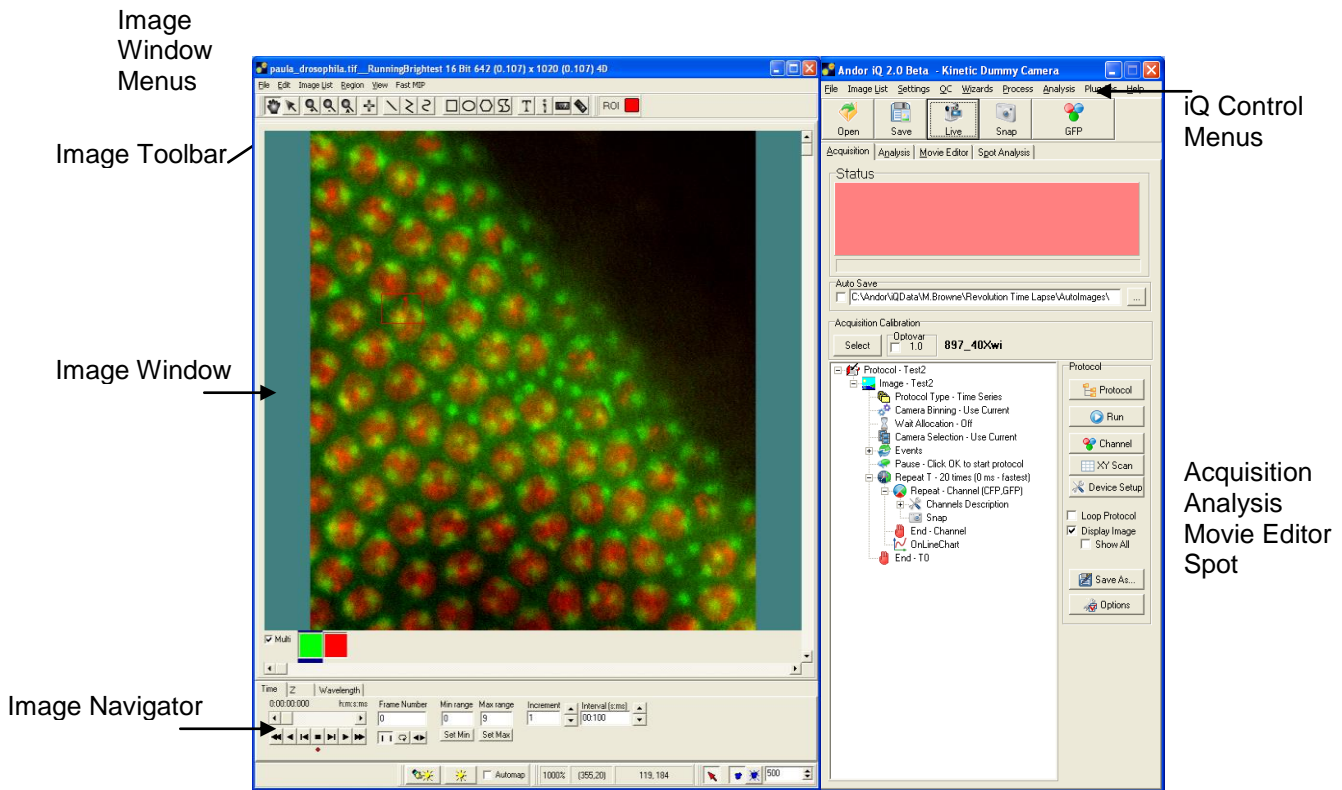

The above picture shows the nD tree view format in iQ which is intended for more complex and advanced experiments.

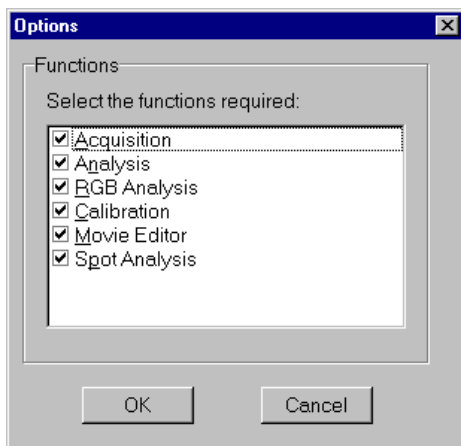

You can select which functions you want to be visible on the iQ interface via the **Function** option in the **Settings** menu of the Control Window. Please refer to **Section 2.6.3** for further details. The following dialogue is displayed, enable the appropriate check box and then press the **OK** button. Page tabs will be displayed for all selected functions.

2.3 Concepts in Andor iQ

Before we begin an overview of iQ functionality, the reader should be aware of some key concepts. These are straightforward, especially if you have some experience of optical microscopy, and once understood will clarify how to utilize iQ to best effect. Please read this section.

The key concepts are **Channels, Scans, Protocols, Triggers and Events, ImageDisk, nDims, Device Setup, and ROI's and Classification.**

To get started we include the following check list of actions to ensure proper effective use of Andor iQ. These should be completed by the Administrator/Installation personnel or key user of the system before general access is provided to others.

Check List

- 1) Configuration Manager – specify hardware to be controlled.
- 2) Run iQ and test hardware communications, boards, etc. through Device Setup dialog.
- 3) Calibrate optical system ($\mu\text{m m}^{-1}$)- objective(s), optivar, C-mount, camera pixel size.
- 4) Run Stage Align Wizard if a multi-well or micro plate specimen is to be scanned.
- 5) Create one or more Channels (Wizard or Device Setup)
- 6) Create and Edit Scans.
- 7) Create and Run Protocol(s)
- 8) Acquire Images and Data.
- 9) Export and Transfer Images and Data for storage and further use.

2.3.1 Configuration Manager

NOTE: The Configuration Manager is only available to Administrators.

To run the Configuration Manager, click on its icon in the Andor Bio-imaging Folder on the Windows Start Menu.

AFTER INSTALLATION ASK LOCAL ADMINISTRATOR TO RUN CONFIGURATION MANAGER. FOR DETAILS SEE APPENDIX.

2.3.1.1 Configurations

Hardware Configurations can be created, edited and deleted in the Configuration Manager (CM). The CM interface is shown below with one configuration expanded to show details of device controllers.

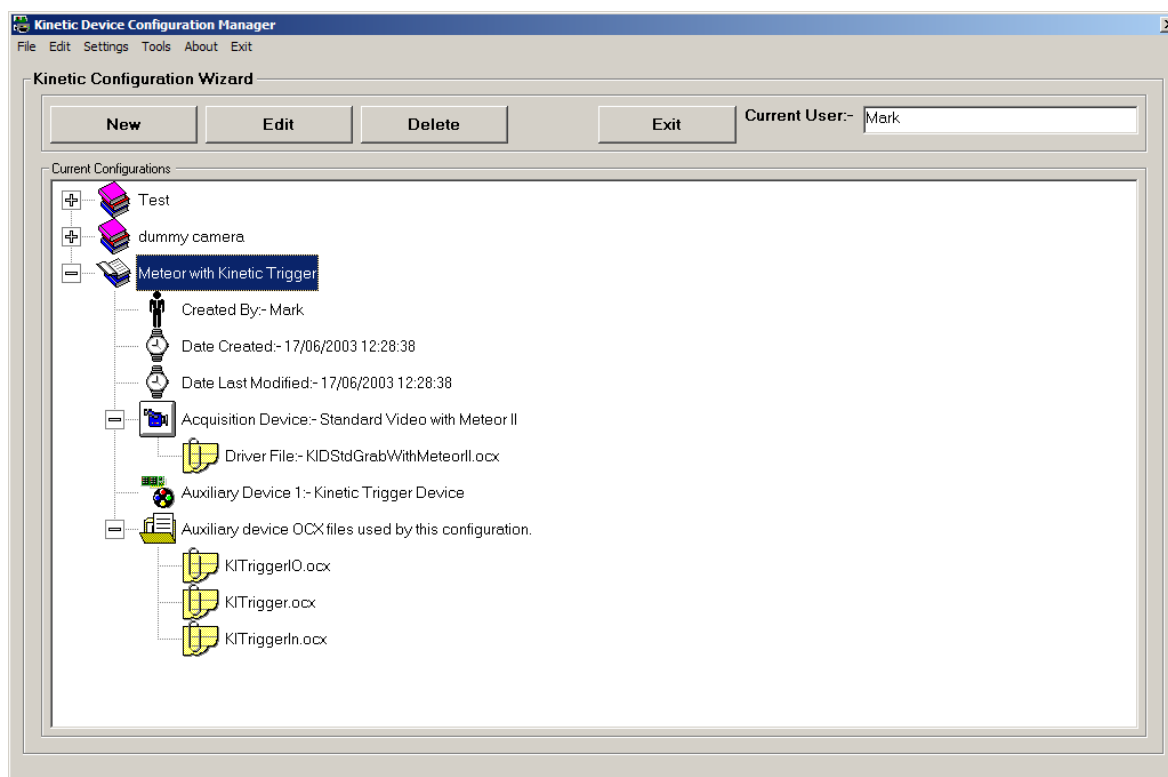

The available configurations are listed in a Tree View, each comprising the following information:

Created By	The name of the Administrator who was logged onto the Local Machine when the Configuration was created.
Date Created	The date the Configuration was created.
Date Last modified	The date the configuration was last modified.
Acquisition Device	The Camera Device used in the configuration. The Camera Device Driver (OCX) used by the Camera Device can be seen by expanding this part of the tree.
Auxiliary Devices	The Auxiliary devices that are contained in the configuration are listed.
Auxiliary OCX Files	The Auxiliary Devices Drivers (OCX's) used by the Auxiliary Devices can be seen by expanding this part of the tree. This is useful for troubleshooting.

2.3.1.2 Global Configuration Settings

For Details on Global Configuration Settings see **Appendix 2**.

2.3.1.3 Software Protection Key

Selecting **Software Protection Key** from the drop down list opens the Software protection Trouble shooter Page.

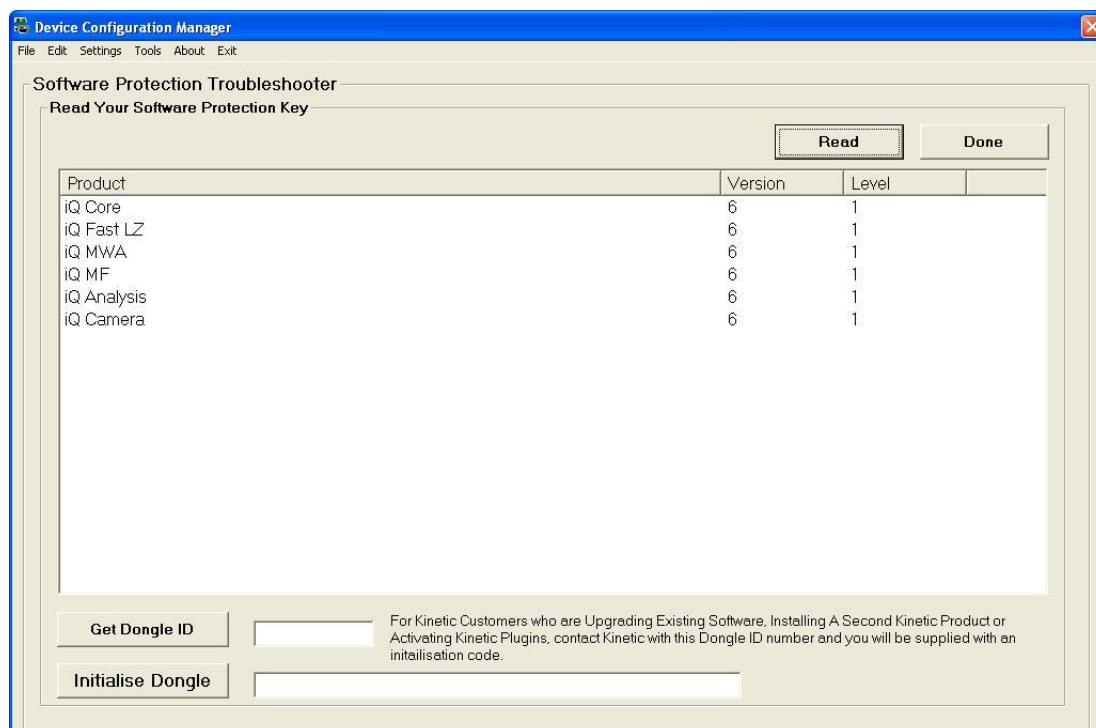

Select the **Read** button to list programs enabled on dongle. Select Done when complete.

2.3.1.4 Upgrading iQ versions

If you are upgrading from a previous version of the software, then your device settings will be retained between versions. You should “Uninstall” the previous version of iQ before installing the new version unless you are installing iQ 3.0 on top of a version of iQ2 or earlier. If provided, please use Andor upgrade tools to ensure backward compatibility of hardware and software.

When you start to use iQ 3.0 you will notice some differences, which we will outline here.

- a. Whenever you select a Configuration, iQ 3.0 will function with your existing Protocols, Channels and Scans from the configuration, but you will need to use the Protocol importer tool to perform a manual copy (see A5.27)

2.3.2 Channels

Channels are settings files, created and managed in the Channel Manager. Channels specify **all** the settings for capturing an image of a specimen in a given contrast mode or with a specific fluorescence probe e.g. phase contrast or DAPI or TRITC.

Channels describe how your hardware devices are set up to illuminate control devices to the sample and capture the image. They are set up using the Channel Manager, which is opened by pressing the **Channel** button on the Acquisition dialogue. Channels also control light source Shutter actions before and after taking an image, and in order for this to be defined correctly, you must set the shutters in the Channel Manager wizard as you will see in Chapter 4.

Once a channel is configured through the Channel Manager (shown here) you can use it to snap single frame images, share it with other users and build it into more

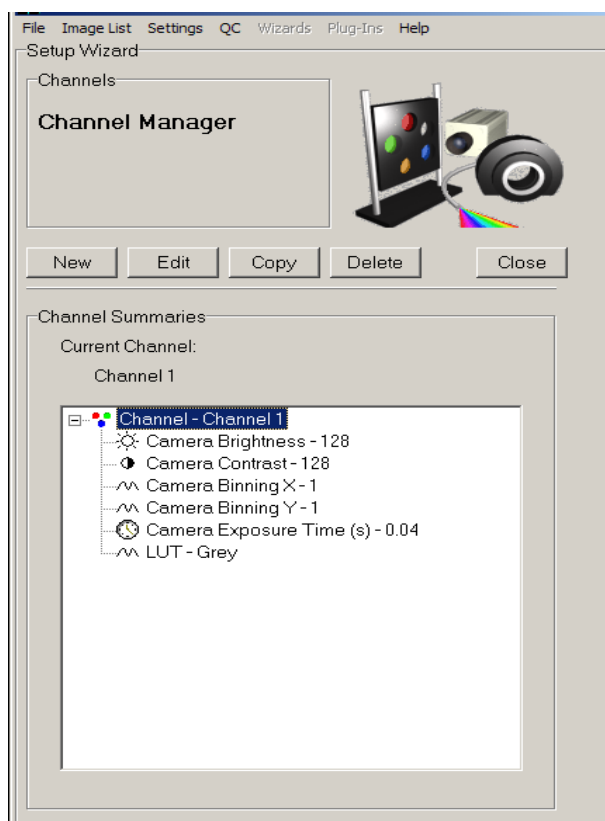

complex acquisition sequences (Protocols). Channels specify settings for cameras, microscopes, filter wheels and shutters – in short anything affecting sample illumination and image capture.

To create a new channel press **New**. A wizard will take you step by step through the creation of the channel, displaying information to help the user at each step. The first dialogue in the Wizard will ask you to enter a name for the channel.

Subsequent dialogues in the wizard will depend upon the hardware devices

included with your system. Detailed tutorials for setting up channels for different types of Experiment are included in Chapter 4 in the User Guide.

To edit a channel select it in the list and press **Edit** or use Device Setup. You will then step through the wizard as with setting up a new channel (except you will not be asked to name the channel), setting up your hardware devices.

NOTE:

Because the channel will be available to all users for a specific hardware configuration, it is important that you have a clear naming convention. For example we recommend the following. Prefix Channel names with a lower case letter for the mode and use upper case for the fluorophore. E.g. vGFP means visual GFP for switching to the eyepieces for user viewing of data, while cGFP means confocal GFP and tGFP means TIRF GFP settings. In this way you can agree and maintain clean and robust system setups.

Copy allows you to create a new channel, having the same setup as an existing channel. Select from the list the channel you wish to copy then press the Copy button. A dialogue will prompt you to enter a name for the new channel:



Type the name into the text box and press **OK**. The new channel will be added to the list, where it can be **Edited** as required.

To delete a channel, select it in the list and press **Delete**.

Press **Close** to exit the Channel Manager, returning to the Acquisition dialogue.

2.3.3 Scans

Scans are created, edited and managed in the Scan Manager. Scans specify the co-ordinate sets for image sequence capture when more than one field of view and/or more than one focal plane in the sample is to be observed. This requires motorized XY and/or Z control. Scans are configured through the Scan Wizard and are inserted and deleted to and from Protocols to specify acquisition sequences. Scan types include multi-well, multi-field and montage types. iQ allows insertion of multiple Z scans, but only one XY scan. Scans specify settings for motorized XY stages, microscopes and piezo focus mechanisms. They can be re-used and edited directly in the nD Protocol Tree (**Section 4.3**). More options are revealed by using a right mouse click.

Scans are set up using the Scan Manager, which is opened by pressing the **Scan** button on the Acquisition dialogue:

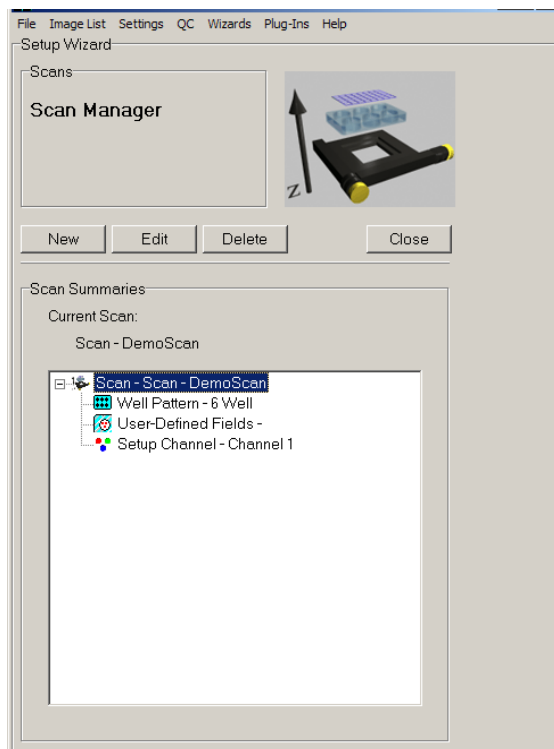

Existing scans are displayed in the list at the bottom of the dialogue. Clicking on the plus sign to the left of each item will display summary information about the scan.

To create a new scan press **New**. A wizard will take you step by step through the creation of the scan, displaying information to help the user at each step. The first dialogue in the Wizard will ask you to select the type of scan. The following options are available:

2.3.4 Protocols

Protocols specify acquisition sequences. An example screen shot from the Protocol Manager is illustrated below. Protocols are created as prototypes (basic forms) and then edited as required by inserting and deleting elements. Protocols persist between iQ sessions and are expressed as a Tree structure on the Acquisition page (**Section 2.6.1**). The Tree structure is an active component, which can be edited with right mouse pop-up menus. The prototype protocols in iQ 3 are always of type Time Lapse and are created with one Repeat-Interval and a single channel named Current. The user can edit protocols and insert nested Time, XY and Z Repeat actions with Channels and other actions as desired. The iQ 3 Protocol structure makes iQ one of the most flexible acquisition platform available.

More advanced Protocols can include multiple channels, scans, moves, trigger in/out, user-defined delays, on-line processing, on-line graphing, pauses which require user input.

Please refer to **Section 4.5 and 4.6** for a description on how to create and use protocols.

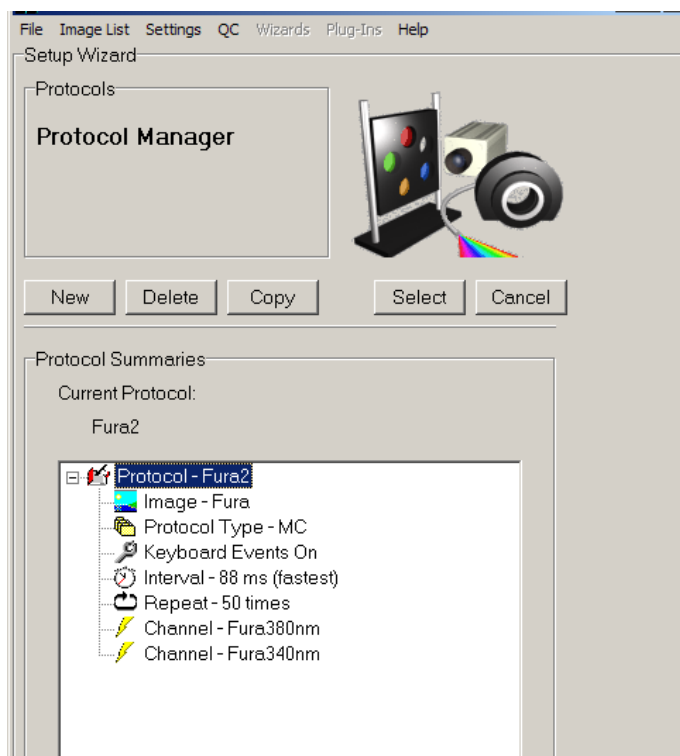

2.3.5 Triggers and Events

Andor iQ now has a powerful set of Trigger commands for protocol control. External synchronization of imaging systems with other forms of data acquisition, specimen stimulation or specimen treatment is important in various scenarios.

Triggers are grouped as “Trigger IN” and “Trigger OUT” commands for inclusion in the acquisition protocol from the Right mouse pop-up menu. Triggers are given simple text names, to ease user interpretation, through the Trigger manager and are used to monitor and control 8 inputs and 8 outputs. Each of these input/outputs is associated with a TTL level signal linked into the imaging system through Andor’s PCU or BOB Trigger Boxes. Each signal is coupled through a BNC connector on the Trigger Box and can be assigned to a specific text label.

In the Protocol a Trigger IN command pauses the acquisition sequence UNTIL the Trigger IN matches the desired state or transition (Hi or Lo or Hi-Lo or Lo-Hi). A Trigger OUT command sends the appropriate signal level (Hi or Lo) or transition (Hi-

Lo or Lo-Hi) on the selected output(s). In this way synchronization events can be passed between systems or devices to ensure that image capture coincides with specimen treatment or exposure whatever it may be.

The Trigger In Signals can also give rise to event markers which are stored within the acquired image sequence. Event markers can be set manually by pressing the Space bar or may be associated with an external hardware input as discussed above.

All event markers are stored with a simple text description and can be edited and added to an image series retrospectively, post-acquisition. Event markers generate graphical cues during Analysis (through series) or data review using the Navigator. Further information concerning the use of Event Markers is provided in **Section 5.6**.

2.3.6 ImageDisk

ImageDisk is virtual memory system which uses a dedicated directory on the system hard disk, or preferably on a separate fast hard disk or RAID array. ImageDisk buffers images for rapid access during capture, processing and analysis and provides permanent storage of data, making it readily available between imaging sessions.

Users will need to manage the ImageDisk to release space when it starts to get full or to Save important data to standard image file formats like (multi-TIFF). Note that Imaris 7.1 now reads the ImageDisk directly and greatly reduce data exchange times between the two.

ImageDisk performance will suffer if a drive becomes too full (80% or more), or if NTFS file format is NOT used. In order to check, double-click **My Computer** and Right-click each Hard Drive, selecting **Properties** from the pop-up menu. This will show the current file system and free space.

The ImageDisk in Andor iQ now warns the user when the disk is becoming full and provides a warning at each 5% increase above 75%. At 90% iQ will demand the

disk be cleaned up and/or backed up.

In Multi-Level Access different Windows users will be provided with a separate ImageDisk folder to ensure that they do not delete or corrupt another user's image data. All images are acquired to the ImageDisk, and the memory management ensures that when system memory (RAM) is limited, rapid disk transfers are used to buffer images not in use. In this way the ImageDisk provides a substantial enhancement to memory management and performance with the large data sets commonly acquired, processed or analyzed in Andor iQ. ImageDisk access and control functions are controlled from the ImageList menu item.

2.3.7 n-Dimensional Images (nDims)

nDims are multi-dimensional images, first introduced in Kinetic Imaging's Lucida , a legacy product for multi-dimensional processing and analysis. nDims are important because they are multi-dimensional containers of the image data, held on the ImageDisk and created when Protocols are run for acquisition or loaded from file. The main advantage of an nDim is that it allows visualization, processing, analysis and storage of all image data as a single object. Selecting and defining the dimensions is achieved with multi-dimensional tools, such as the Image List (**Section 2.5.2**), Navigator (**Section 2.9**) and Selector (**Section 2.8.2.6**). All this combines to makes operations on the large data sets simple and rapid - a real benefit to the user. It also helps to minimize the difficulties associated with file management of multi-dimensional datasets.

2.3.8 Device Setup

The **Device Setup** button on the Image and Control windows opens a dialogue for setting up and configuring all external hardware devices included with your system. This dialogue is available to all Users. Only Local Machine Administrators can change hardware settings (e.g. COM ports, board configurations, etc).

Dependant upon the devices included, different options will be available which are accessible from additional page tabs. Information for most devices supported by iQ can be found in the manufacturers supplied manuals or in **Appendix 3**.

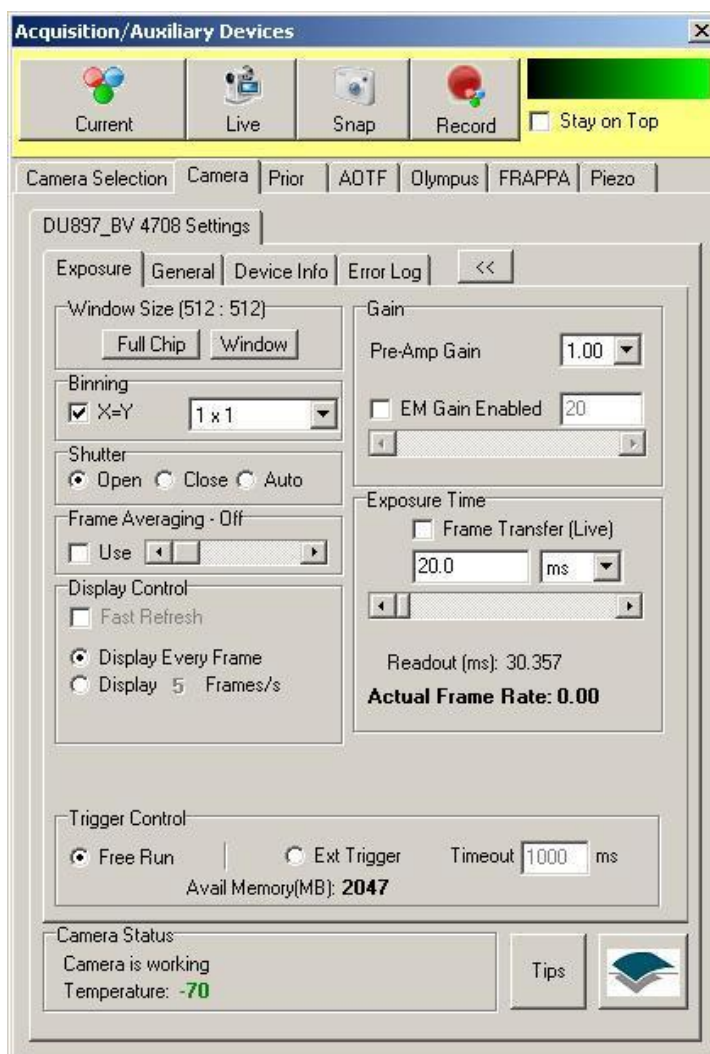

2.3.9 ROI's and Classification

Regions of interest (ROIs) can be readily defined and subsequently analyzed using iQ's analysis tools.

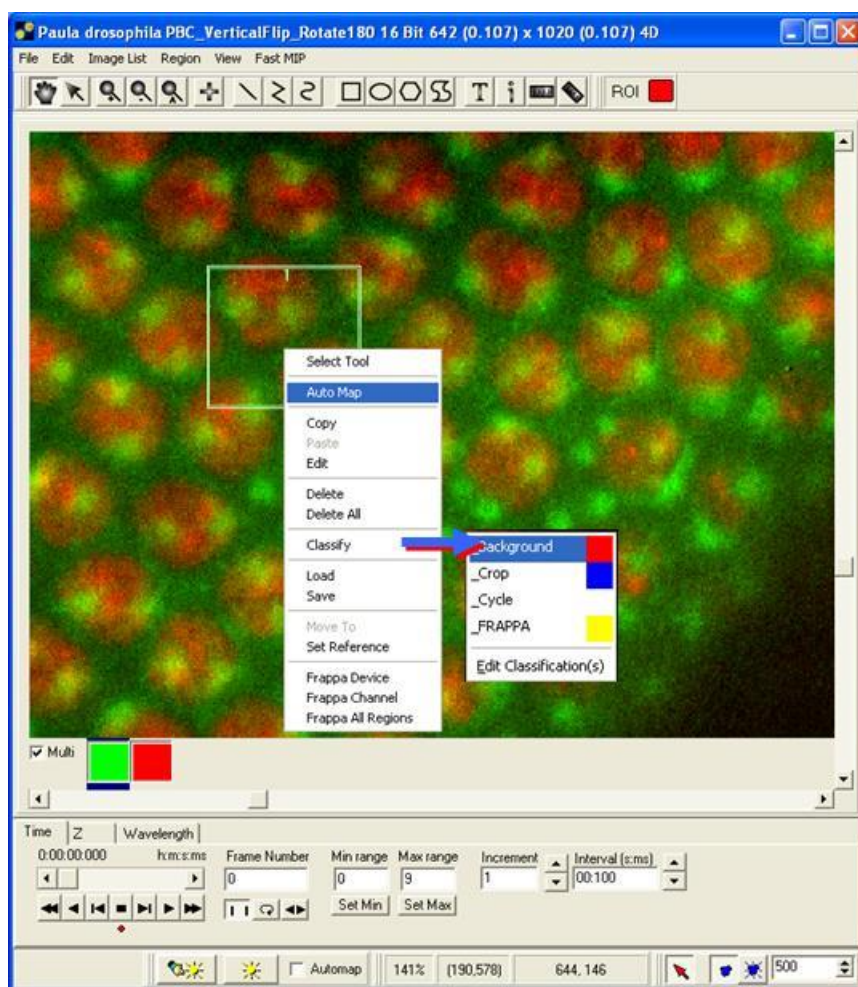

Analysis parameters such as mean pixel intensity, peak intensity, etc are readily computed for a complete data set or from user defined regions on the image. ROIs may be constructed using any combination of size and shape. Regions can be of line, polyline, rectangular or elliptical in type and more complex figures can be drawn using the polygon or freehand polygon tools.

The analysis of ROIs is useful for the through-series analysis of temporal or Z-series data. Discrete regions drawn using the same color can be classified and assigned to a particular feature or class assigned by the user. Multiple regions from the same class may be analyzed individually or combined as a group and a background correction can be applied during analysis using background ROIs. Further information regarding ROI classification and the use of the Feature Definition function is described in **Section 2.8.4**. The use of ROIs during image analysis is discussed in **Section 4.6.1**.

2.4 Supported Image File Formats

Andor's file handling tools allow for import of wide a range of file formats as described subsequently in **Section 2.5.1**

Imported file formats supported by iQ are listed as follows:

AVI, BioradMRC, Bitmaps, Fenestra (Kinetic Imaging), Olympus GB200, JPEG (*.jpg, *.jpeg), Kontron (IMG), Micro Voxel, MIF, Multi-Load (*.*), Photometrics, Princeton Instruments, Targa, Adobe TIFF standard, Andor Multi-TIFF, UserDef (allows Raw import of images with known bit depth, XY and header size), Visilog, Zeiss LSM (*.ism), Andor Solis (*.SIF).

Images may be exported from iQ using any of the following formats:

AVI, BioradMRC, Bitmaps, Fenestra, JPEG (*.jpg, *.jpeg), Kontron, Micro Voxel, Photometrics, TIFF files.

2.4.1 Five TIFF formats are available for saving images:

TIFF (multi-image file) - Image saved in a multi-frame format retaining its original bit depth.

TIFF (8/24 bit multi-image file) - Image saved in a multi-frame format. Bit depth information is retained if the original image is 24-bit or 8-bit data. For 12 bit and 16 bit depth images, the image is subsequently saved as 8-bit data.

TIFF (single image file) - Image saved in a single plane format retaining its original bit depth.

TIFF (8/24 bit single image file) - Image saved in a single plane format. Bit depth information is retained if the original image is 24-bit or 8-bit data. For 12 bit and 16 bit depth images, the image is subsequently saved as 8-bit data.

TIFF (LZW) - A compressed image, saved as a multi-frame format.

2.5 The iQ Control Window

The Control Window has three main parts:

- Window Menus,
- Toolbar
- Function Tabs.

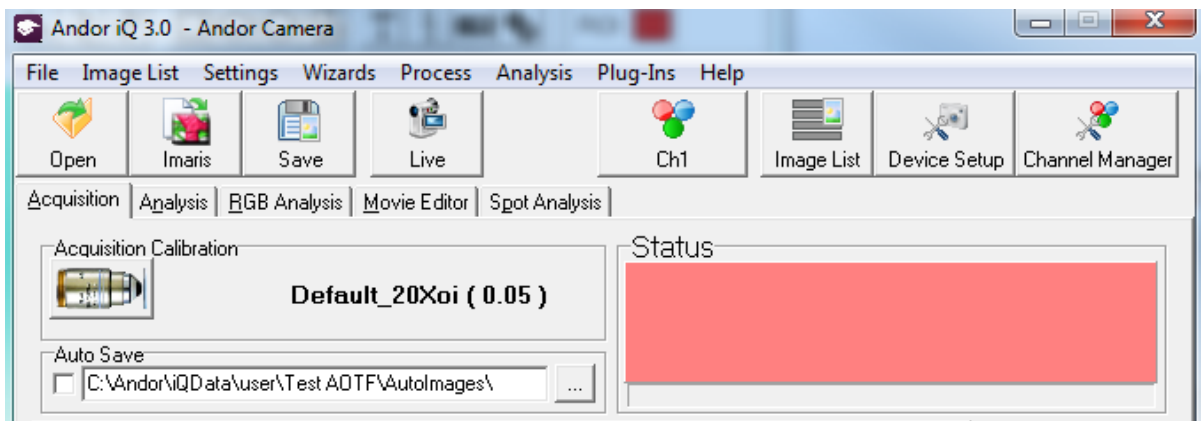

2.5.1 The File Menu

The File Menu is used to load images from and save images to disk, to specify the default directory for saving Experimental data and also to exit from iQ.

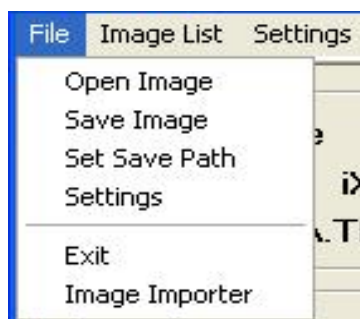

Open Image - open an image from disk. If you open an image while Live, the system will return to Idle and the image will be opened.

The example below shows the dialogue when opening images using the **Multi-Load option**. Multi-Load enables the import of multi-dimensional data following the selection of a single file in the appropriate directory

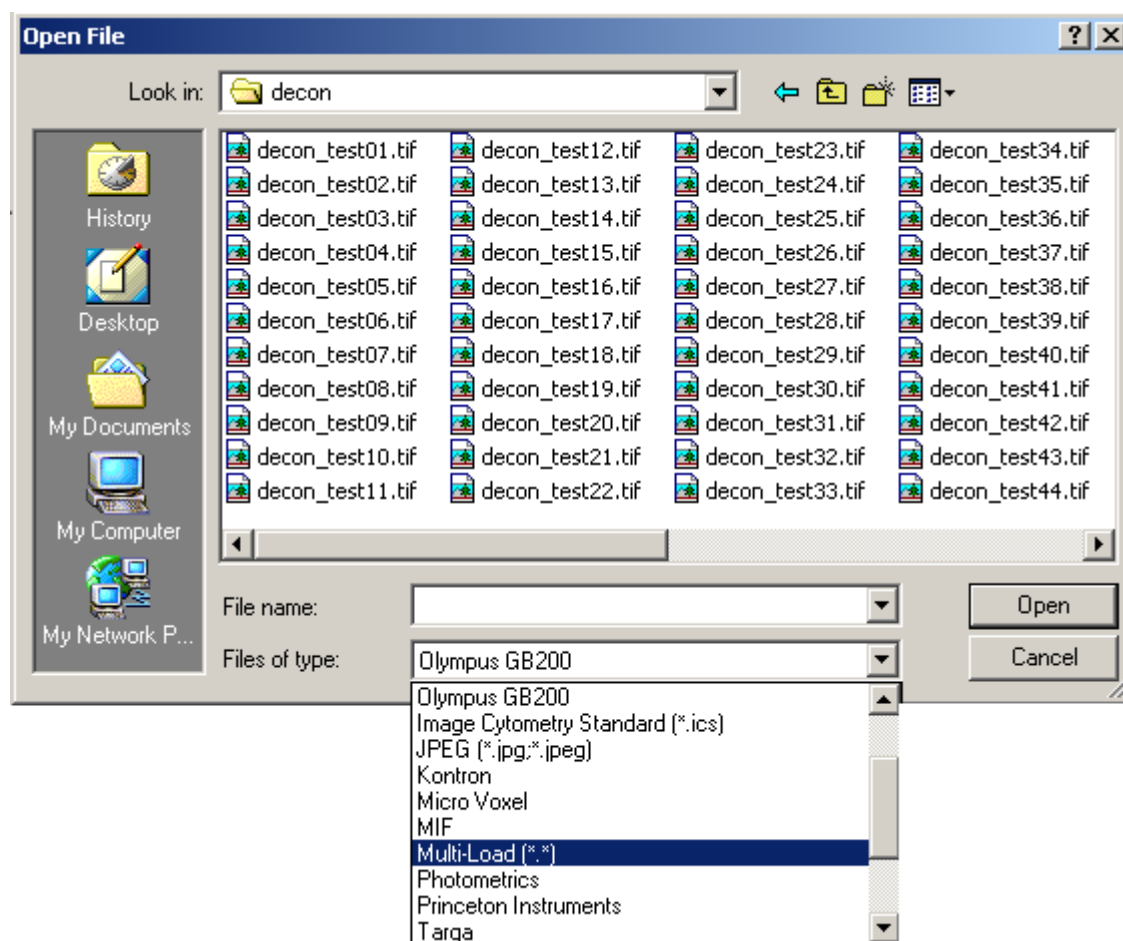

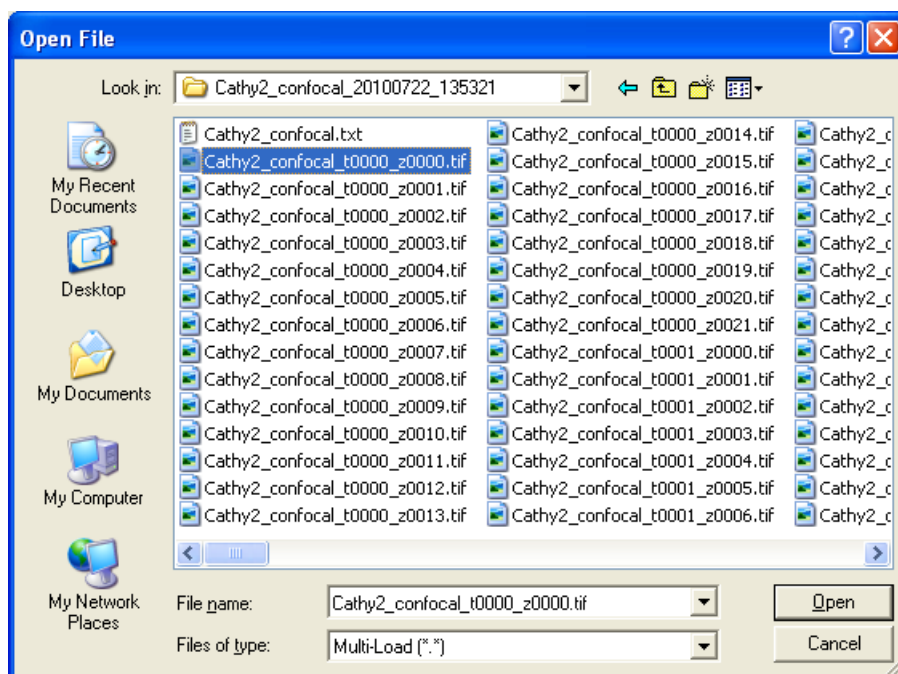

Once a file has been selected and the **Open** button pressed, the status of the import operation is displayed in a progress bar as the image files in the directory are constructed into an n-Dimensional image. The default 3rd dimension is time, but this can be edited using the Dimension Editor as described in **Section 5.2.5**.

Only files with matching names are imported using the Multi-Load option (e.g. If two image series [red01.tif - red80.tif] and [red_01.tif - red_80.tif] are resident in the same directory. Initially selecting image red01.tif will subsequently Multi-Load the [red01.tif - red80.tif] image series. If the red_01.tif image is selected, the [red_01.tif - red_80.tif] series will be loaded).

Save Image - save an image to disk.

This opens a standard Save File dialogue, in which you can specify a filename and directory to which to save the image.

When saving files the user should be aware of the fact that some file types support multi-dimensional images while others support on single XY frames. The main types handled by each format are listed below.

Single frame formats: Bitmaps, Fenestra, Kontron and TIFF

Multi-frame formats: AVI (usually compressed), Biorad MRC, ICS, Microvoxel, STK, TIFF, TIFF LZW.

A list of all supported file formats was discussed previously in **Section 2.5**

Note: Bear in mind that if you try to save a multi-dimensional image into a single plane image file then only the first frame will be saved.

Set Save Path - specify the default directory to which experimental data is saved. When you save experimental data, the Save File dialogue will point to the specified directory by default.

Image Importer – import an image or series of images from a 3rd party program. iQ uses its own naming convention when importing or exporting a multidimensional image as a series of single files. E.g. `MyImage_t0001_w0001.tif` indicates that the image has both time and wavelength dimensions. When the images do not meet this requirement, Image Importer Wizard, in addition to some user input, can open them as a familiar multidimensional image for viewing, manipulation and export. The first step is shown here.

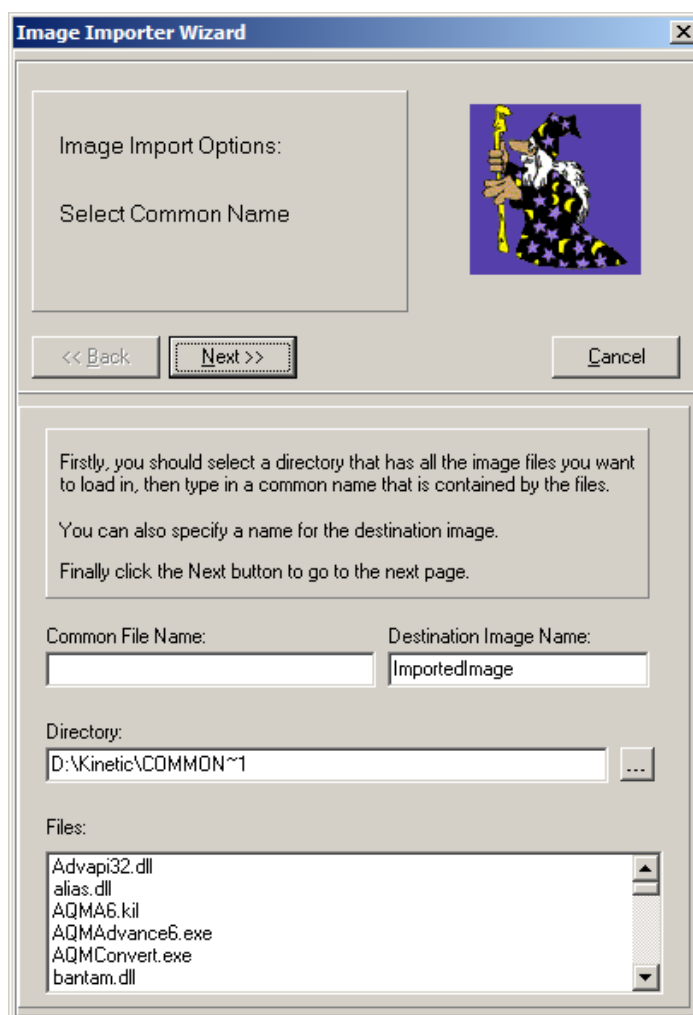

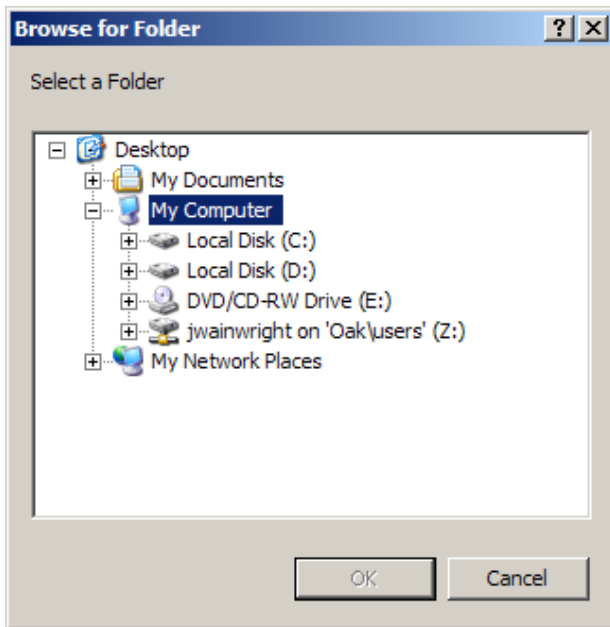

Pressing the  button brings up a browser window from which the directory containing the images can be selected.

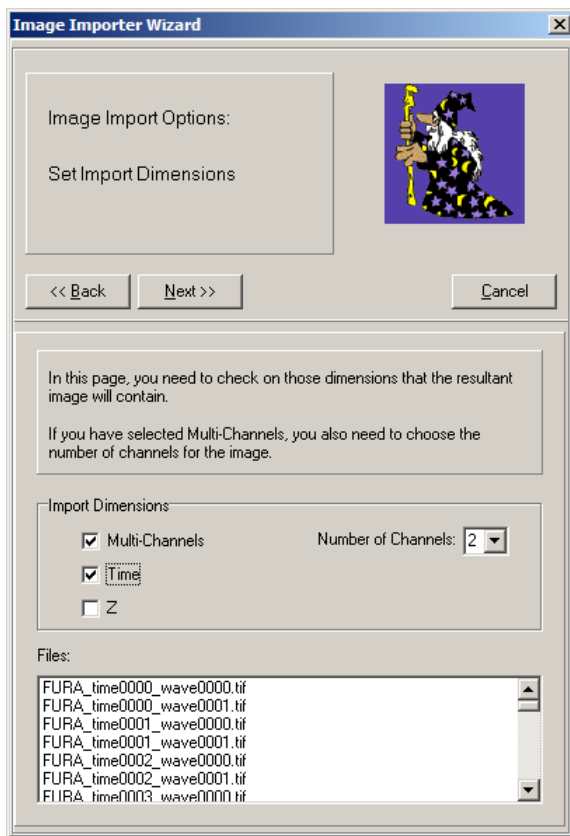

In this example, the beginning of the file name (`FURA_time`) is common to *all* the files we wish to import, so this is entered into the *Common File Name*: box.

Pressing Next will show the following step:

In this step, the dimensions of the images must be entered. In this case, there are two channels and series through time.

If there is only one channel, untick the *Multi-Channels* checkbox.

Press **Next**.

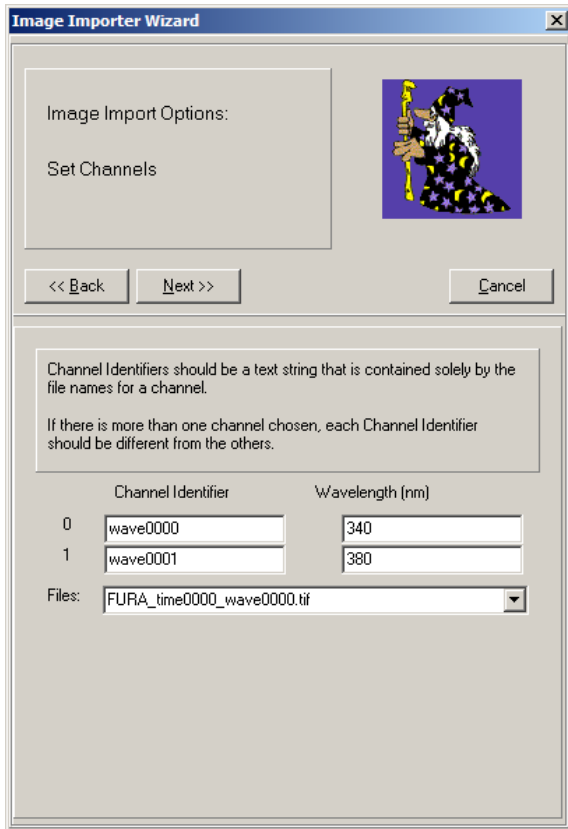

Now the two channels must be identified by their file names.

Channel 0 files end wave0000 and Channel 1 files end wave0001. These are entered in the *Channel Identifier* boxes respectively and the wavelengths (if known) in the *Wavelength(nm)* boxes.

Press **Next**.

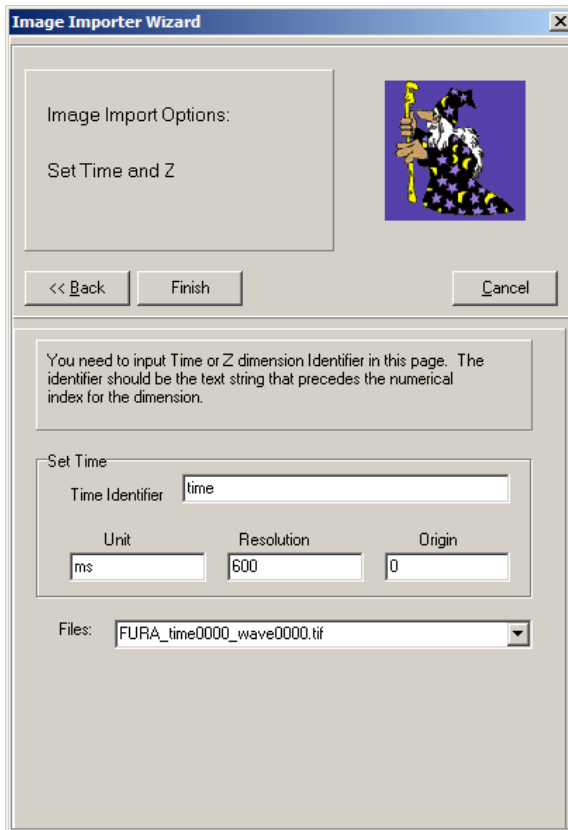

Whereas the wavelength identifier was wave0000 and wave0001, the time identifier in this example is just `time`. The units are known to be approximately 0.6 seconds, starting at time 0. Specifying 'ms' in the *Unit* box (and consequently '600' in the *Resolution* box) gives the more familiar *h:m:s:ms* time format in the navigator toolbar. Specifying 's' will give the time format in s only.

Press **Finish**.

The Multi-Load progress bar will appear and the images will be loaded into the Image Window to be analyzed in the same

way as a single multi-dimensional image file.

2.5.2 The Image List and Metadata

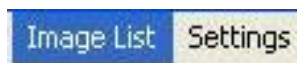

The **Image List** shows which images are held on the Image Disk. All images are opened or acquired and buffered on the Image Disk. This provides rapid and efficient access to the large data sets associated with multi-dimensional imaging.

Note: Flexible protocol execution may create multiple image entries to support complex tree structures. For more information see Chapter 4.

Clicking on the **Image List** menu item opens the dialogue shown below.

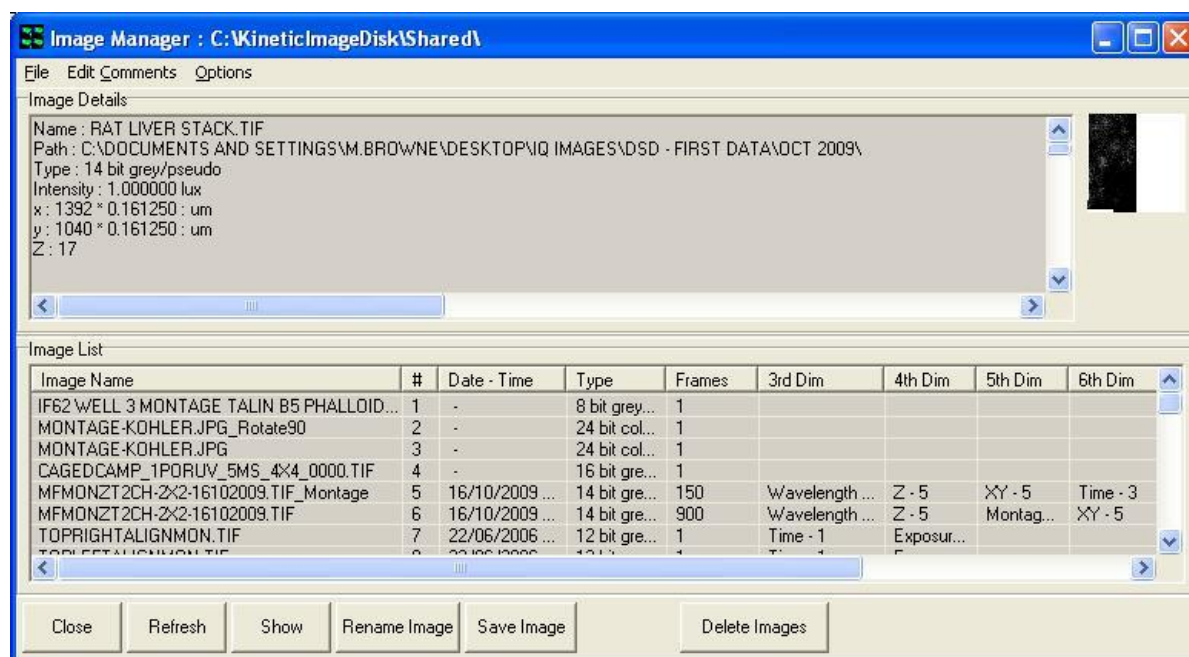

Image Details - When an image is selected in the Image List, the **meta-data** information about the image is displayed here. **Details** of the content and layout of the Image **meta-data** are included in **Appendix 4** of this user guide.

If more than one image is currently selected, details are displayed of the latest one to be selected.

Image List - click on an image name to select. Selected images are highlighted. You can use standard multi-select key strokes, click with CTRL and Shift to select more than one image. You can **Delete** or **Save** the single or multi-select with the appropriate button click.

Most buttons are self explanatory, but where more information is needed we provide it below

Refresh - this button refreshes the Image Manager interface. Function key 5 (F5) will achieve the same result.

Show - this button displays the image. Double mouse click in the list will also show the selected image.

Rename Image – Simply type the new name into the text box and press **OK**. The name of the image will be updated in the Image List. You can copy and paste to the edit box here.

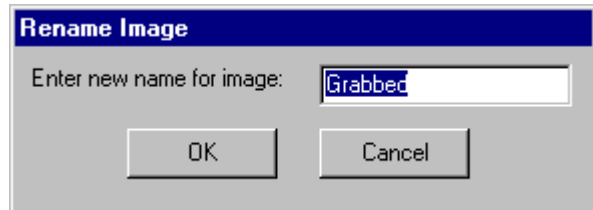

Save Image – When a single image is selected this button opens a standard Windows Save File dialogue, in which you can save the image to disk

When Multiple Images are selected then you are provided with an option to delete an image once it has been successfully saved.

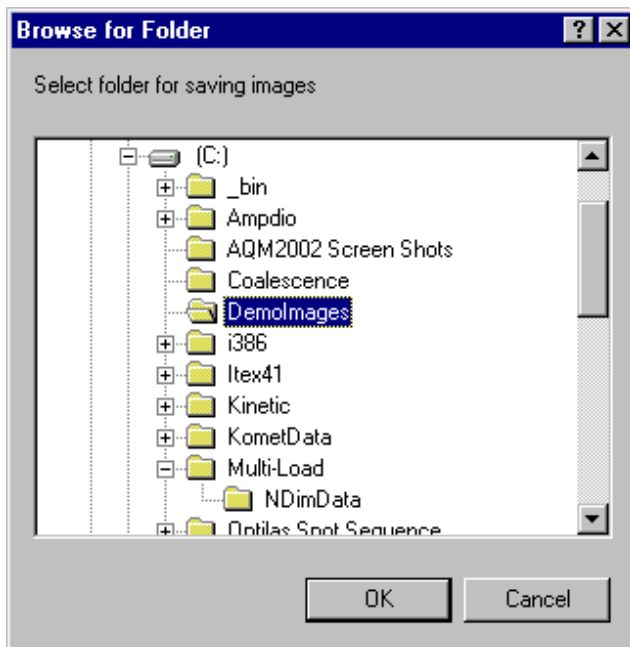

Before the file save operation can commence, a folder must be selected for storage of the multiple image set. After clicking the OK button, the save process commences and a message appears at the end of save operation.

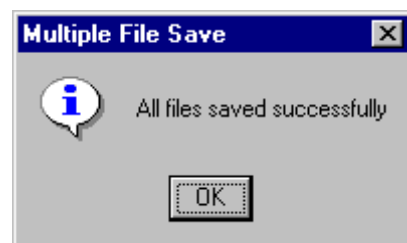

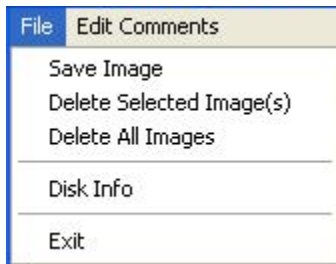

File – this menu item opens the following dialogue. This provides an alternative route for saving image data and deleting images from the Image List.

Edit Comments – Clicking on this button opens the following dialogue.



Comments can be typed into the text box as illustrated above and are saved in the image header by clicking on the OK button. The comments associated with any image can be viewed by scrolling down the Image Details field in the Image Manager. They are stored in an image header field named

[Comments]

Text here...

[Comments End]

For more information on the image header Metadata see Appendix 4.

2.5.3 The Settings Menu

To aid in desktop management, iQ allows you to select the functionality to be displayed. Clicking on the **Function** option enables selection of the functions that you wish to be displayed. Page tabs will be displayed for all selected functions in the iQ Window.

- Function
- Hot Keys
- Interval Setup
- Max Auto TimeOut

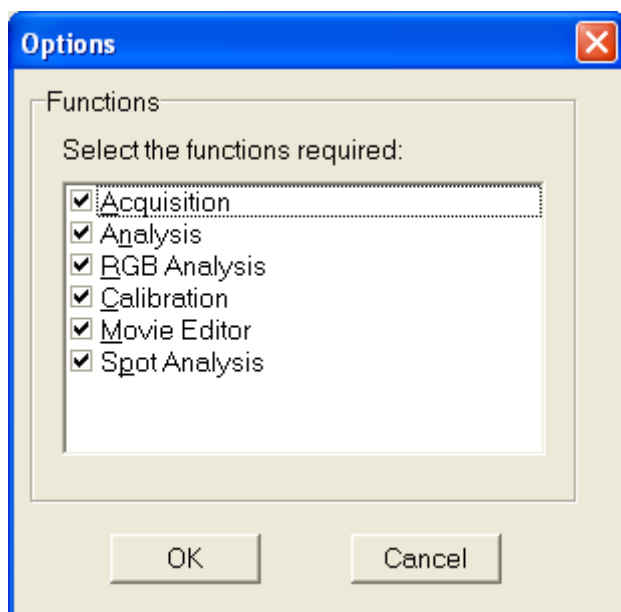

The **Max Auto Timeout** setting allows you to specify how long that a timed iQ dialog will show before it closes and takes default action. These dialogs are intended to allow unsupervised actions like shut down in the event of power failure, editing settings after a Load Protocol action and so forth.

A comprehensive description of iQ functions and page tabs is provided in **Section 2.6**.

Clicking on the **Hot Keys** menu item enables function keys to be assigned to any channel previously defined using the Channel Manager. A maximum of six keys can be assigned during any iQ session.

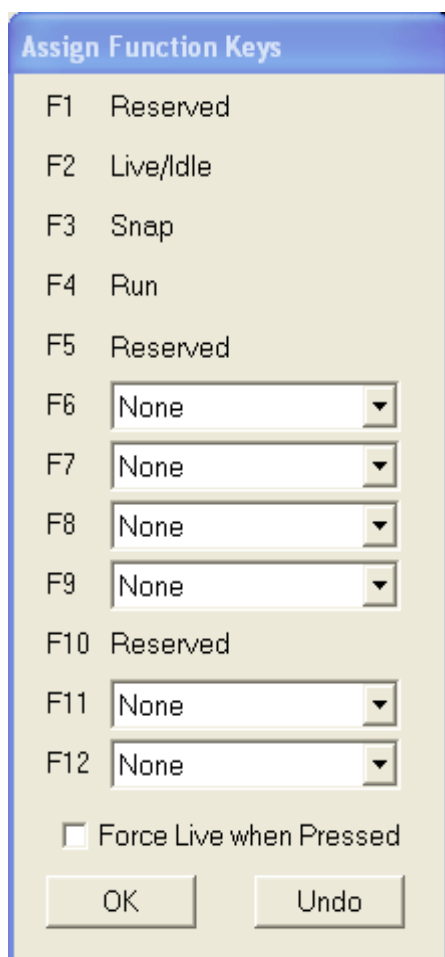

Pressing a function key will change the current channel to that specified by the hot key. If the **Force Live when Pressed** checkbox is enabled, a live video image will be displayed in the Image Window using the appropriate image acquisition settings.

Pressing the **OK** button exits the Assign Function Key dialogue. The **Reset** button returns all the hot keys to the **None** state, no channels are associated with any of the function keys.

Three of the function keys are reserved and cannot be assigned to a channel. The F1 key is used to access Windows Help information and the F5 key is used to refresh the iQ Image List.

The **Interval Setup** item enables a list of intervals to be created which can be subsequently accessed during the execution of a protocol, allowing different repetition intervals to be used. This function allows sampling rates to be adapted to the experimental condition.

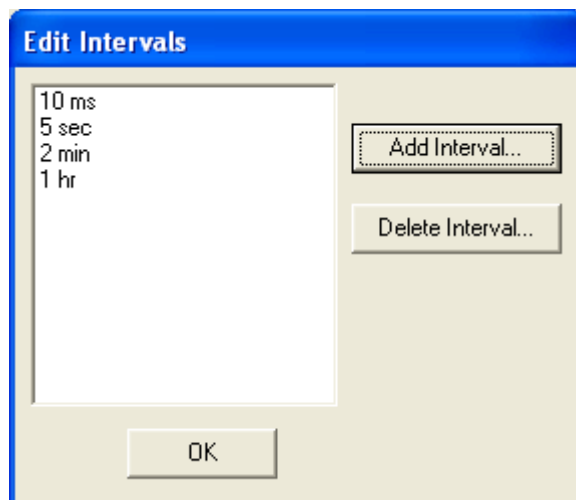

Repetition intervals may be inserted in the list by clicking on the **Add Interval** button and pressing **OK**.

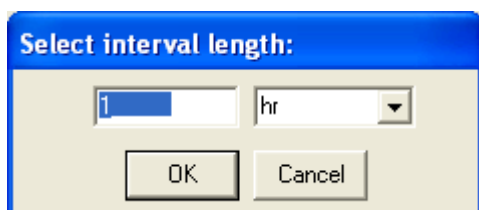

Interval lengths may be specified in milliseconds, seconds, minutes or hours.

Intervals are removed from the list by highlighting the unwanted item and clicking the **Delete Interval** button.

During a live acquisition sequence, the list of repetition intervals is accessed by right clicking on the Interval item in the nD Protocol Tree.

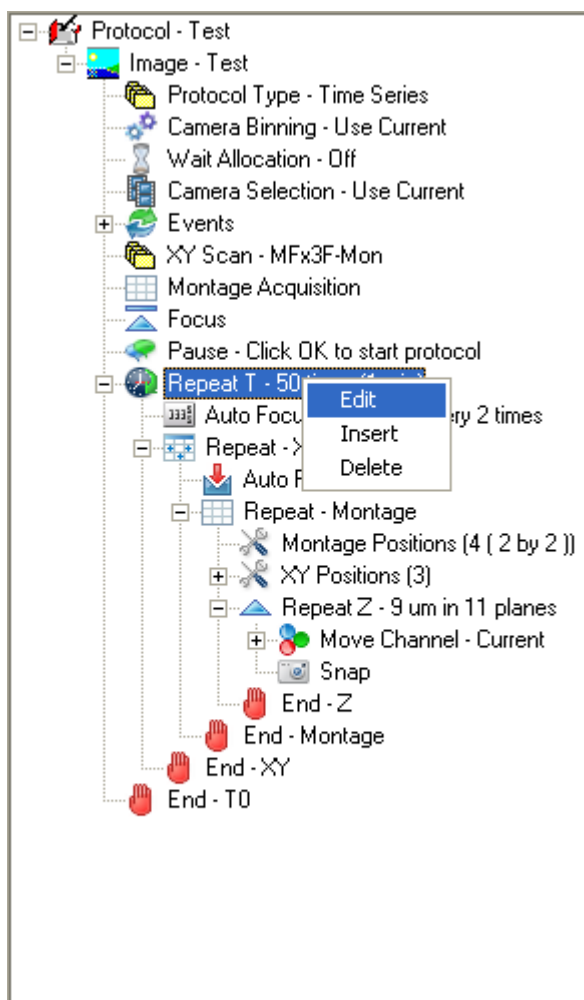

The appropriate sampling interval is selected by clicking the right mouse button.

2.5.4 The Wizards Menu

The **Wizards** menu offers access to all calibration related actions and to **Channel** and **Protocol** wizards. Further information on the use of the Wizards is described in **Chapter 3**.

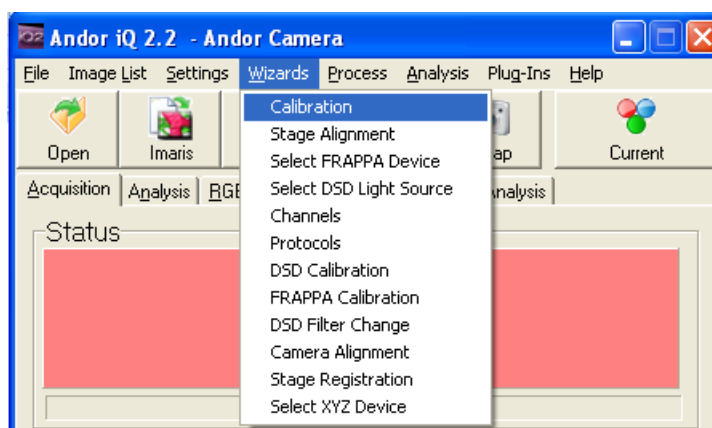

2.5.5 The Process Menu

Selecting Process from the file menu accesses additional functions. These functions are listed in the adjacent picture. A comprehensive description of the Process options currently available may be found in **Section 5.1**.

2.5.6 The Analysis Menu

Further information on the use of these functions is described in **Sections 4.6**.

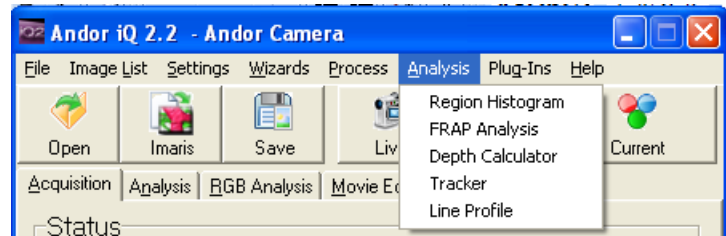

2.5.7 The Plug-Ins Menu

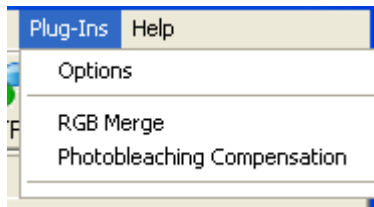

Selecting **Plug-Ins** from the file menu accesses additional functions.

The selected functions are now available for use during subsequent iQ sessions. A comprehensive description of the Plug-In functions currently available may be found in **Section 5.2**.

2.5.8 The Help Menu

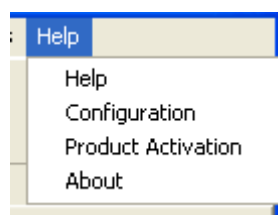

Selecting Help from the file menu will give you three options. First selecting **Help** from the menu opens the iQ Online Help file.

Selecting Product Activation from the Help Menu opens the Status window. From here you can see the available Andor iQ modules. A tick mark indicates activated products. The right side of the dialogue shows which modules are activated and the existing time limit (if any).

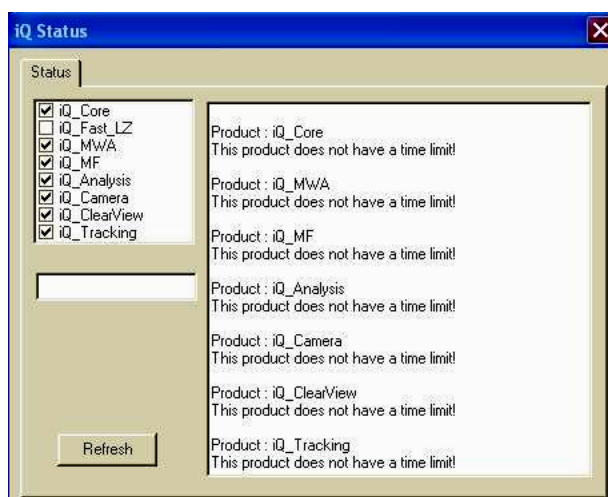

Select the **Refresh** button for changes to show.

Please contact Andor Bio-imaging division for further details on activating iQ Modules.

Pressing the **About** button displays information about the software and contact details for Andor Systems Division.

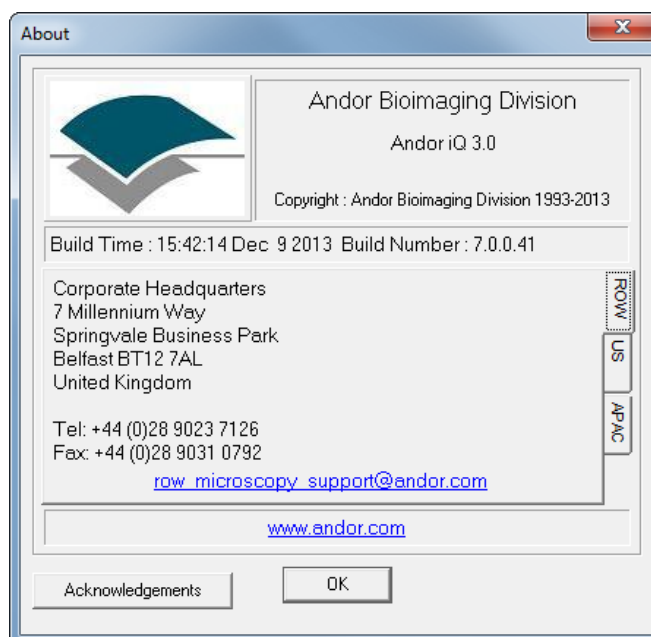

2.6 Function Tabs

2.6.1 Acquisition

The **Acquisition** tab enables set up and execution of experimental Protocols.

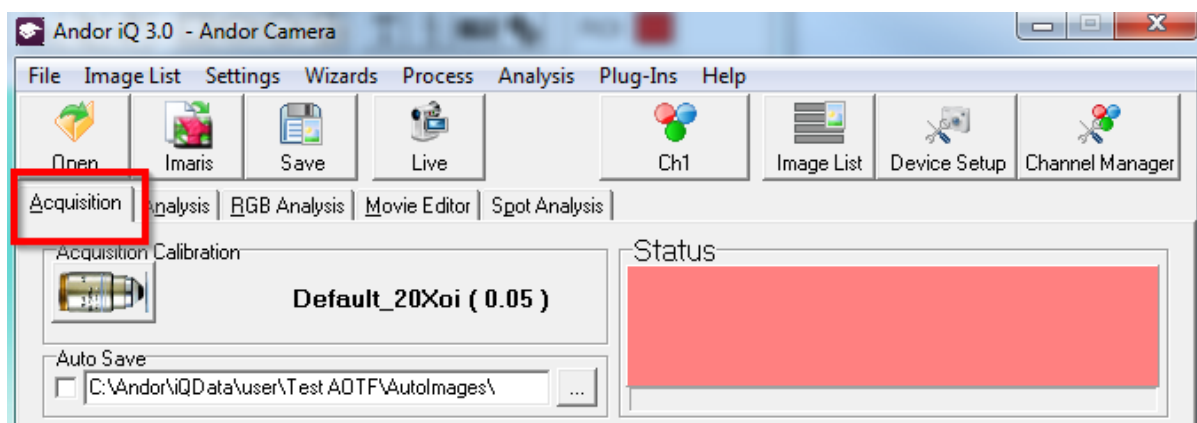

2.6.1.1 Status Box

The **Status Box** displays the current status of your system. A message describes the current status and the box is color coded:

Pink - **Idle** - The system is Idle - i.e. not capturing.

Cyan - **Live** - **Live** video is currently displayed in the Image Window.

Yellow - **Arming system** - **Run** has been pressed and system is initializing or waiting for **Trigger IN**.

Green - **Acquiring data** - Busy State Protocol is running and shows progress.

Blue - **Exposing node (time remaining)** - If one of the Channels in the Protocol has an exposure time > 1second, Status will turn blue and the time remaining to complete exposure will be displayed.

The progress of the Experiment is displayed in the progress bar below the Status Box.

2.6.1.2 Toolbar

The toolbar provides quick access to the Open, Open with Imaris, Save, Live, Snap and Channel functions.

Click on **Open** or **Save** to obtain a standard Windows Open/Save File dialogue, in which the image can be loaded from or saved to disk.

Click on **Open with Imaris** to launch Imaris (if installed on the system) with the current iQ image automatically loaded.

When **Live** button is pressed, its text changes to **Idle** and live video is displayed in the Image Window until the (**Idle**) button pressed again.

Live mode is used for interactive focusing of the system and adjusting the imaging device prior to Protocol execution. Adjustments to the camera etc. can be made directly via **Device Setup** or Channel Manager.

Snap is used to acquire 1 frame of an image. On pressing **Snap** the label on the button will change to **Stop**. To cancel Snap with a long exposure time, press **Stop** to abort it.

Channel button - shows the current selected Channel - see screen shot.

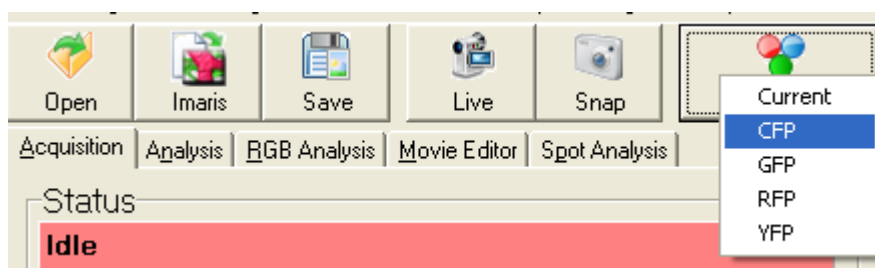

When you click on the button a popup menu shows the list of Channels available and allows selection

of one of these.

If you select a Channel from the dropdown and then press **Live**, iQ will drive the system hardware to the recorded Channel settings, pre-frame events associated with the channel will occur (e.g. shutters will be opened) and then **Live** video will be displayed in the Image Window.

2.6.1.3 AutoSave

Auto Save can be toggled on and off by clicking in the checkbox. When selected the checkbox is labeled with a tick and on completing the current Protocol the image will automatically be saved to disk with the name given in the Protocol and an extension including the date and time.



To specify a folder in which to Auto Save, press the button on the right. A dialogue will ask you to select a folder. Note this can be a remote or network drive.

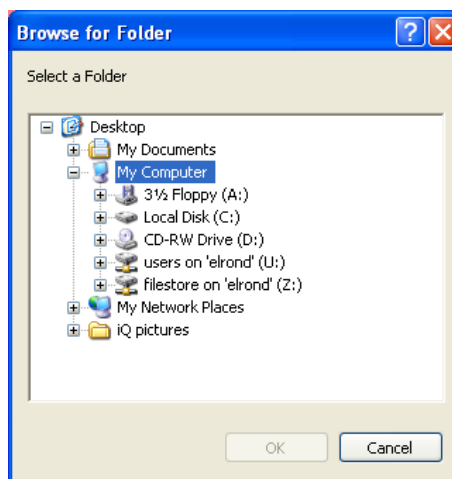

Select the drive and folder then press **OK**. The folder name will be displayed in the Auto Save text box in the Acquisition dialogue.

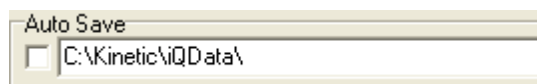

2.6.1.4 Protocol

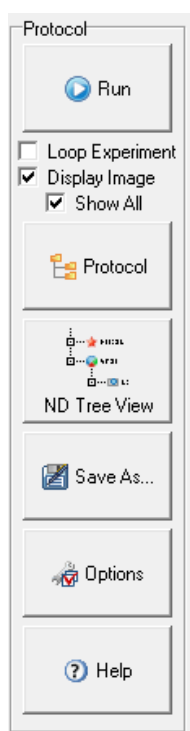

The **Protocol** section of the dialogue is used to set up and control experiments:

Pressing the **Protocol** button will launch the Protocol Manager. The Protocol Manager allows you to Select or Delete a Protocol from the list or create a New Protocol. New Protocols are created as Prototypes, which are then either edited in the nD Protocol Tree by Edit, Insert, Delete and other keyword specific actions or in the new iQ3 6D view interface. After completing the setup you will return to the Acquisition dialogue, where the Experimental commands are displayed in a tree-type structure. Further details regarding the use of the Protocol Manager are described in **Section 4.4**. Note that any Channels or Scans to be included in the Experiment must be set up

first from the Channel (**Section 4.2**) and Scan (**Section 4.3**) Managers (press the **Channel** or **Scan** buttons, respectively to access these functions).

2.6.1.5 Run, Channel, Scan, Device Setup, Store, Store As



After an Experiment is set up, press **Run** to start. The button label will change to **Stop**. To cancel an Experiment before completion, press **Stop**.

The **Channel** button opens the Channel Manager (**Section 4.2**), which allows the setup of channels. (Channels describe how your hardware devices are set up to illuminate and expose the sample).

Click on **XY Scan** to open the Scan Manager (**Section 4.3**), which allows the setup of scans. These are used to analyze samples at more than one field of view in the XY plane and/or at different Z coordinates in a Z series. A scan pattern defines at which XYZ coordinates the sample will be illuminated and exposed.

The **Device Setup** button opens a dialogue in which all the hardware devices included with your system can be set up and configured (**Section 2.3.8**).

Loop Protocol is toggled on and off by clicking in the checkbox. When selected the checkbox is labeled with a tick and on completing the Protocol it will repeat using the same specified criteria, overwriting the previous acquisition. To end the Protocol press **Stop**.

If Loop Protocol is deselected, the current Protocol will run to completion and then the system will return to Idle.

A possible application for Loop Protocol is where you want to capture an event whose starting time is unknown. Simply waiting for the event to begin and then pressing **Run** would result in you missing valuable data at the start of the event. You can therefore leave the Protocol Looping, ensuring that you capture the whole of the

event, after which you can stop the experiment.

If **Display Image** is selected, live video is displayed in the Image Window during the image acquisition. If de-selected, live video is not displayed. This option has the advantage that the image acquisition is quicker.

The **Store / Store As** buttons are used to save Protocols. The information in the Protocol Command Tree will be loaded/saved.

2.6.1.6 6D protocol

The **6D** Protocol panel provides an intuitive interface for creating complex acquisition sequences and allows a maximum of 6 dimensions. You can configure the details of the protocol actions using the panels that are shown below. Protocol actions are placed into an execution stack when iQ prepares to Run the Protocol.

The screenshot shows the Andor iQ 3.0 software interface. The main window is titled "Andor iQ 3.0 - Andor Camera" and features a menu bar (File, Image List, Settings, Wizards, Process, Analysis, Plug-Ins, Help) and a toolbar with icons for Open, Imaris, Save, Live, Ch1, Image List, Device Setup, and Channel Manager. Below the toolbar are tabs for Acquisition, Analysis, RGB Analysis, Movie Editor, and Spot Analysis. The interface is divided into several sections:

- Channels Panel:** Located on the left, it displays five channels (Ch1 to Ch5) with color-coded bars and buttons for "Add/Remove", "Live", "Snap", and "Multi-Snap".
- Ch1 Configuration:** A central panel for configuring the first channel, including "Exposure" (0.001 ms), "Excitation Intensity" (480 nm at 29.2%, 561 nm at 70.8%), and "Global Settings" (Binning: X=Y 1 x 1, Size: Sub Array).
- Protocol Panel:** On the right, it contains a "Run" button, checkboxes for "Loop Experiment", "Display Image", and "Show All", and a "Protocol" tree view.
- Z Scan Panel:** A button labeled "Z Scan" located below the Channels Panel.
- XY Scan Panel:** A button labeled "XY Scan" located below the Z Scan Panel.
- Time Lapse Panel:** At the bottom, it includes a "Time Lapse" section with a "Chart" icon, a "Pre-allocate all images" toggle (currently Disabled), and a table for configuring acquisition phases.

Duration	Interval	Number	Stream
14.0 sec	3555.71 ms	4	<input type="checkbox"/>
14.0 sec	3555.71 ms	4	<input type="checkbox"/>
28.45 sec	3555.71 ms	8	<input type="checkbox"/>

Callouts on the right side of the image point to the following elements:

- Channels Panel
- Run current protocol
- Protocol Tree View
- Z Scan Panel
- XY Scan Panel
- Time Lapse Panel

2.6.1.7 nD Protocol Tree

You create nD **Protocol Trees** from the **Protocol Wizard using New**. But you configure the details of **Tree Actions** with the right mouse menu which shows Edit, Insert and Delete when the context allows it. Tree Actions are placed in to an execution stack when iQ prepares to Run the Protocol. Stack construction allows iQ to build complex protocols with Repeat loop nesting to many levels, subject to final image dimensionality not ten. If a Tree Node has a plus sign (+) to its left, a mouse click on the (+) will expand the tree as shown here.

A right mouse click on an Action in the Protocol will open a pop-up menu, in which the appropriate options for that command are displayed. For example, right clicking on a **Channel** node will display the following options:

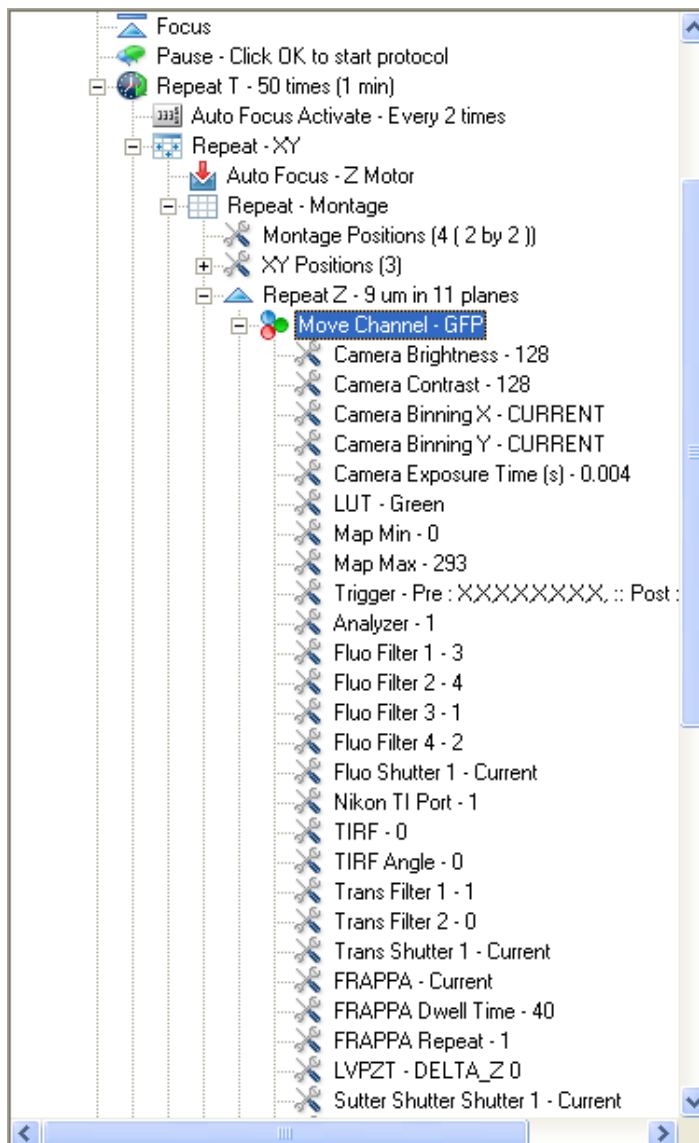

Andor iQ USER GUIDE

Live	Go live with that channel
Move To	all hardware devices will move to the settings specified for that channel
Adjust Camera	Adjust the hardware settings for that channel
Delta Z	Adjust a new Z position - an offset which allows you to correct for chromatic effects in the optics and acquire the channel at a different Z positions for any reason.
Acquire	Acquire an image with the hardware devices set up as specified by the channel
Edit	Allows for editing the channel and brings up channel manager
Insert	Insert a new keyword below this move channel. The Tree Insert dialog containing a list of valid keywords for insertion will appear to allow the user to choose.
Delete	Deletes the channel from the protocol

The available keywords or Actions that can be used in a nD Protocol Tree are described in some detail in Chapter 4:

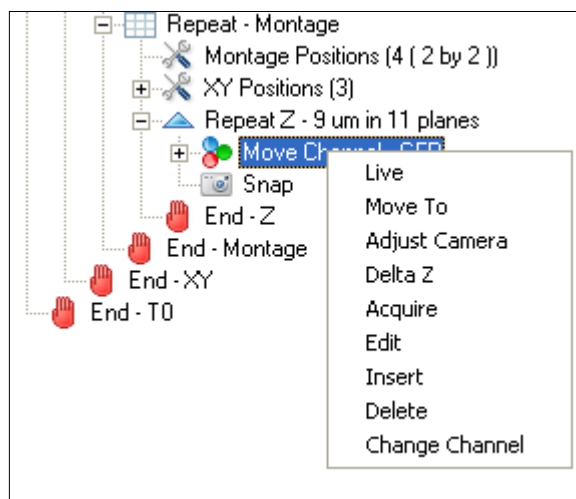

2.6.2 Analysis

The **Analysis** Tab is used to calculate statistics for the current image or, if drawn onto the image, user-defined regions. Results are displayed in both graphical and numerical format. Further details concerning the Analysis page are provided in **Section 4.6**.

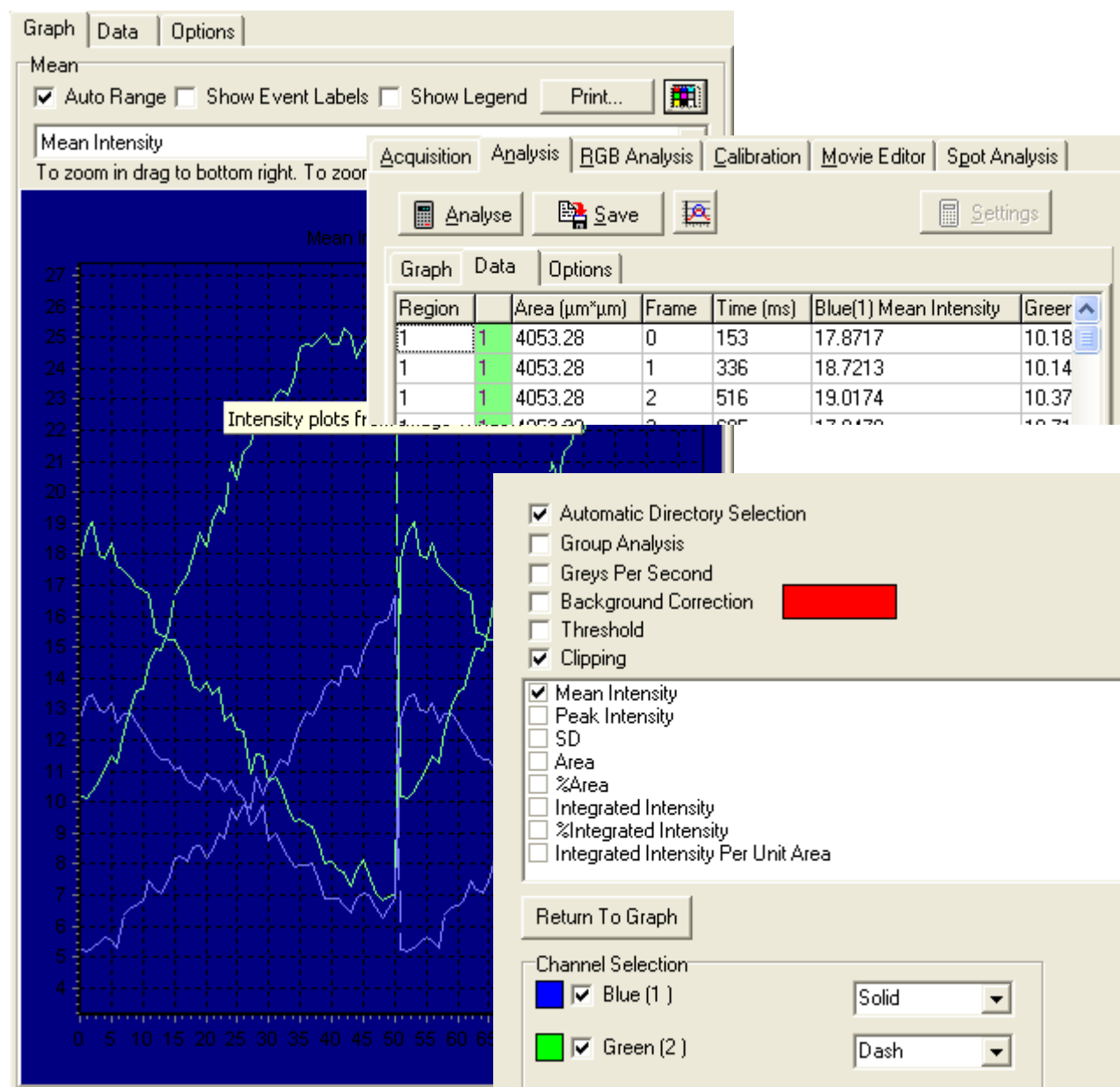

2.6.3 Movie Editor

The **Movie Editor** is used to create animation sequences from frames of interest, which can be subsequently saved as AVI Movies.

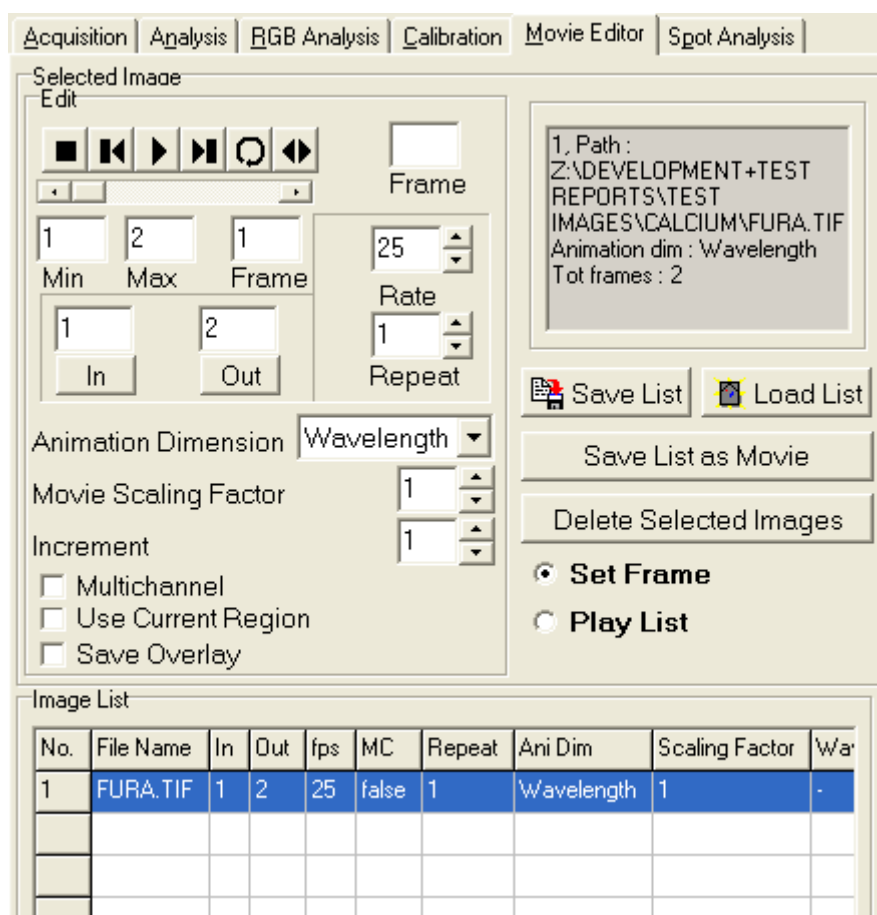

The use of the Movie Editor is described in **Section 5.8**.

To get started, select this dialogue use **ImageList** to show an image in the Image Window, it will then appear in the list. Use Set Frame option to edit parameters and Play List to preview. Then Save List as movie to save window's AVI.

2.6.4 Spot Analysis

The Spot Analysis Tool is used to quantify the morphology, density and intensity of discrete objects. Further details regarding the use of the Spot Analysis Tool can be found in **Section 4.10** of the User Guide.

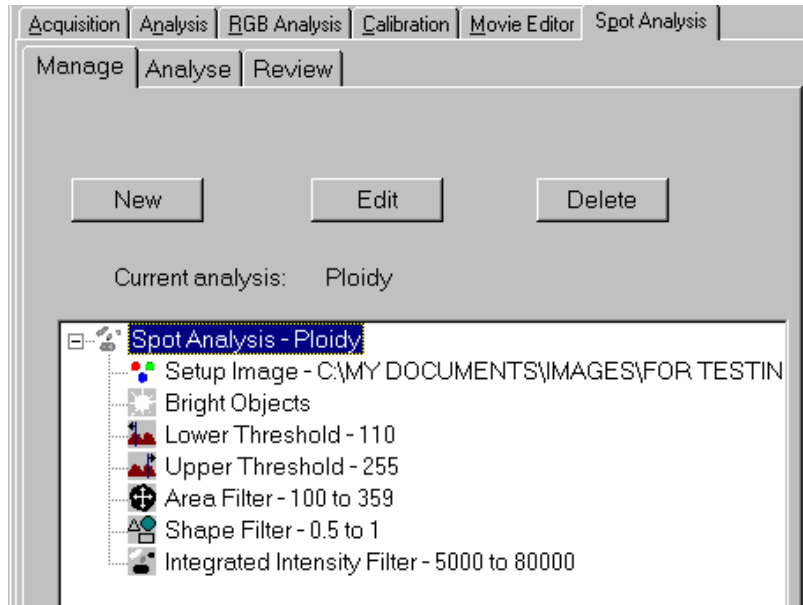

2.7 The Image Window

The current image is displayed in the Image Window.

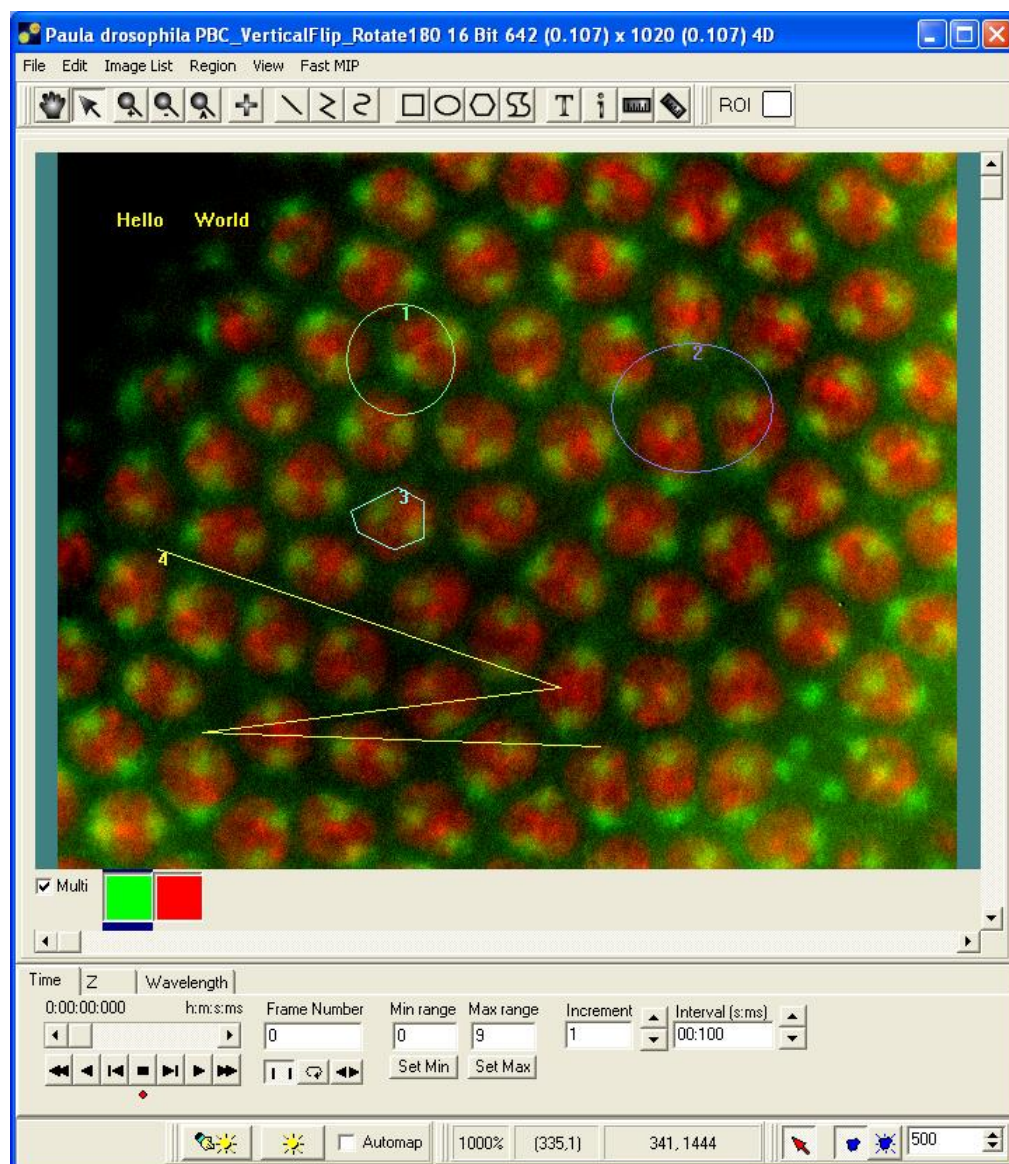

The Image Window will update the displayed image in response to several actions. For example whenever the **Live** or **Snap** buttons are clicked on the Control Window, or when the **Run** button is clicked with the **Display Image** option selected, on the Acquisition tab. The Image Window updates when you Show from the Image List or use the Open Image File menu. When iQ opens from it displays the last image displayed in the previous session.

When on-line **Ratio** processing is executed during a Protocol, a tab named **Ratio** will

be visible below the Image Toolbar. This tab allows you to switch the display between the Ratio and the Raw images.

The Image Toolbar:



Regions of Interest (ROI's) can be defined about features of interest on the image, using the **Define Point**, **Define Line**, **Define PolyLine**, **Freehand Polyline**, **Rectangle**, **Ellipse**, **Polygon** and **Freehand Polygon** buttons, and classified according to user-specified features using the **Current ROI** button in the Image Toolbar (**Section 2.10.17**). Statistics can then be calculated for each ROI (or class of ROI) in the Analysis or RGB Analysis dialogue.

2.7.1 Image Contrast or Mapping Control



The **Manual Mapping** button opens the Image Contrast dialogue, which presents histogram(s) and tools for setting the Maximum and Minimum mapping values. This is shown on the next page. The mapping transfer function is shown as a red line overlaying the histogram plot. For multi-channel images one set of tools is provided per channel. Changing the Max and Min values and adjusting the transfer function will modify the display in the Image Window, to improve contrast or view specific image features. The underlying image pixel intensities remain unchanged.

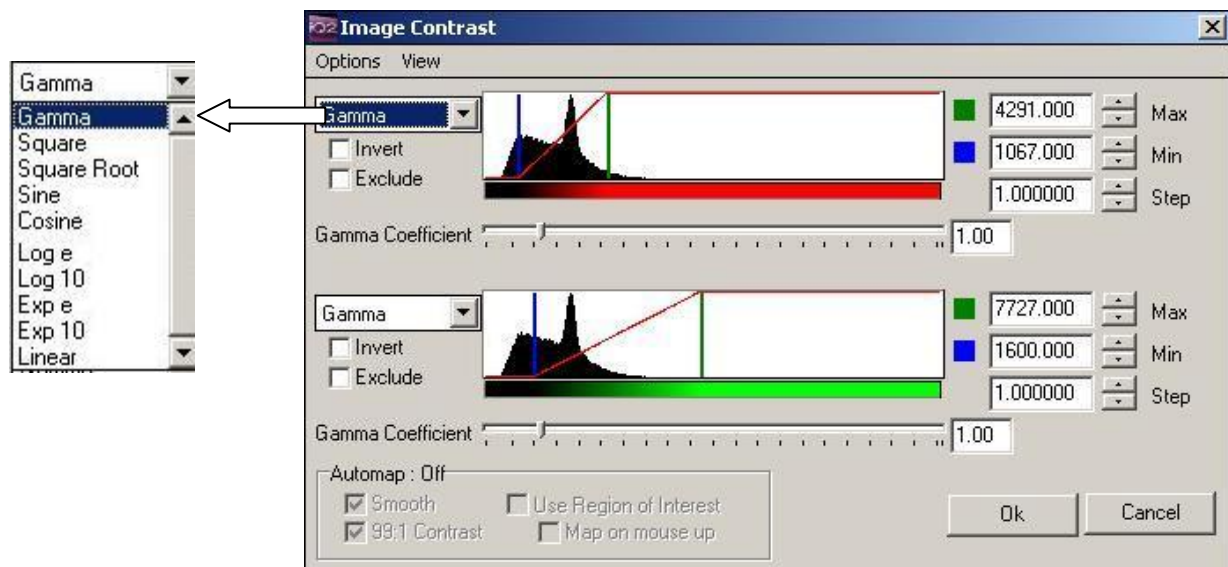

2.7.1.1 How the Mapping Table Works

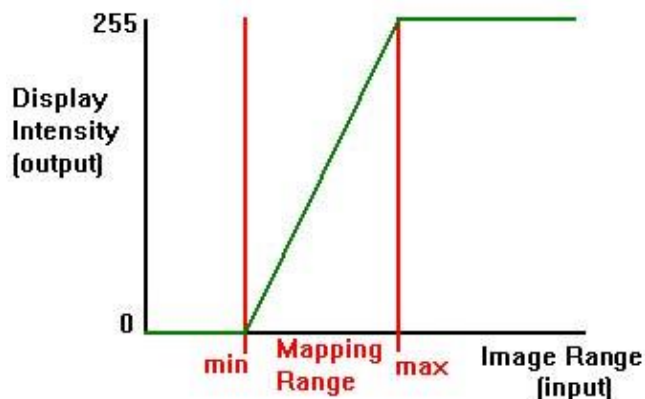

To display images of dynamic range greater than the computer monitor, we need a method to convert image grey value to display value, which is limited to the range 0-255. To do this we use a “Mapping Table”. For display, the intensity of each image pixel is converted to a display intensity value based on the transfer function of the mapping table as shown in the figure. The Mapping Table form can be manipulated in iQ with the Mapping dialog to achieve an extremely wide range of display effects. When combined with pseudo-color LUTs (look up tables) image intensities can be rendered for virtually any purpose. **Section 4.1.1.**

2.7.1.2 The Mapping Dialog Tools

In the sequence of figures shown here you can see the uses of the various tools available in the Mapping Dialog. The figure here shows typical histograms from a two channel image.

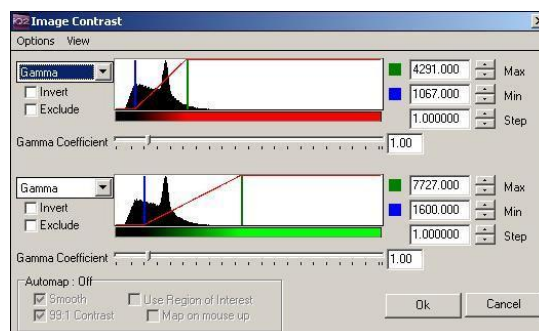

Set the Max and Min mapping (or scaling) values in the image using the spin buttons or typing a number into the edit boxes on the right of the dialog. Spin button step size is set by the Step setting. Alternatively, you can grab (click and hold down the mouse) the Blue (Min) and Green (Max) vertical bars on the histogram graphic and drag left or right. The left mouse button controls the Min value, while the right mouse

button controls the Max value. The image will be updated on the “mouse-up” action.

To invert the mapping (flip contrast) check the Invert option. To set values above Max to zero check the Exclude option. To change the Channel Mappings together, select the “Link Channels” check box and use the Edit boxes or graphical tools as described above and now both ranges will change together.

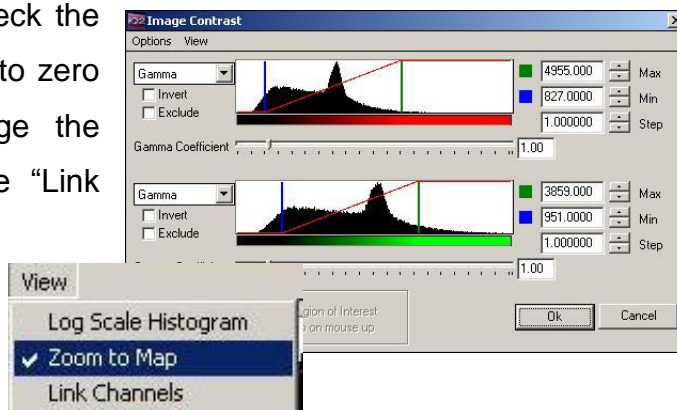

The horizontal scaling of the histogram is linear, which may make it difficult to study histogram details in images with a low dynamic range. Selecting “Zoom to Map” scales the histogram X axis around the Min-Max values, as shown opposite.

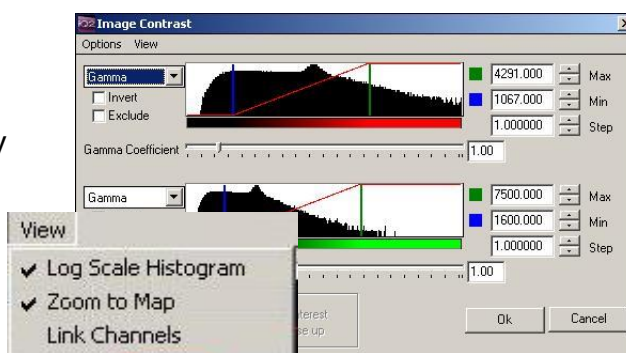

The vertical scaling is also linear by default, so that low frequency grey values may be difficult to see on the graphic. Selecting the “Log” checkbox transforms the histogram Y axis to a logarithmic scale, emphasizing the low frequencies, as shown opposite. This situation occurs in fluorescence imaging, where the image histogram may be dominated by high frequencies of background.

2.7.1.3 Auto-Mapping Tools



Automatic mapping can be used “single shot” by clicking on this button or checked on a Right mouse popup in the Image Window or lower Image toolbar. The Automap function estimates the Mapping range values from a sample of the image pixels and adjusts the table to provide a high

contrast, bright display. When checked, Automap operates every time the image is updated, as in Live or Animation. Further options are available when Automap is enabled. “Use ROI” operates on the currently selected ROI for mapping, allowing the range to be adjusted as the ROI is roamed over the image. “Map on mouse up” activates an Automap action whenever a Mouse Up event is detected in the Image Window e.g. when a ROI is moved over a captured image.

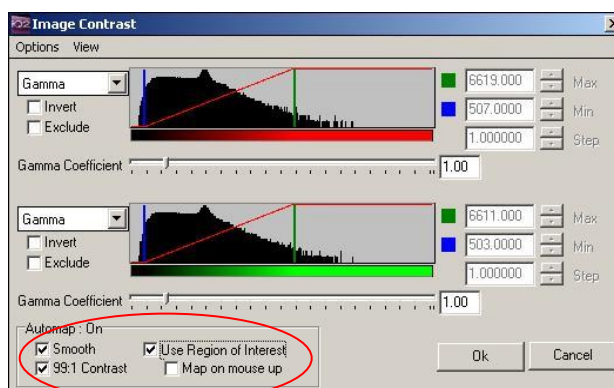

2.7.1.4 Reduced Flickering

Automap now provides additional improvements to reduce flickering when using automap. The “Smooth” option only rescales the image when the min or max value changes by a significant amount (configurable in the Options dialog). The default change required is 5%.

The “99:1” contrast option autoscales to the center 98% of pixels. This cuts out outliers in the high and low ends resulting in less flickering and more punchy image.

2.8 The Image Window Menus

The Image Window Menus are used to manage images, image views and to provide Tools for ROI's used in analysis.

2.8.1 The File Menu

Open Image, **Save Image** and **Exit** Loads and Saves images to and from disk and Exits from iQ. This has the same functionality as the iQ File Menu (**Section 2.6.1**).

Open with Imaris provides the same functionality as the main toolbar and launches Imaris with the currently loaded image.

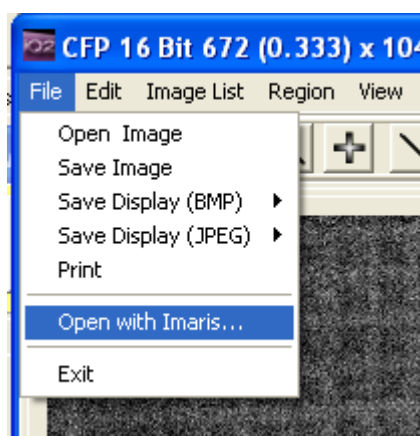

The **Save Display** menu item includes the ability to save several different features of the image to disk in **Bitmap** or **JPEG** format:

Regions - the positions of all user-defined ROI's are saved, superimposed on a blank image.

Highlight - all parts of the image highlighted by, for example, adjusting the threshold settings for an Analysis are saved, superimposed on a blank image.

Image - the source image is saved to disk.

All - all contents of the Image Window are saved to disk, including the original source image, user defined ROI's and image overlays.

The **Print** item enables the contents of the Image Window to be printed using a standard Windows printer interface.

2.8.2 The Edit Menu

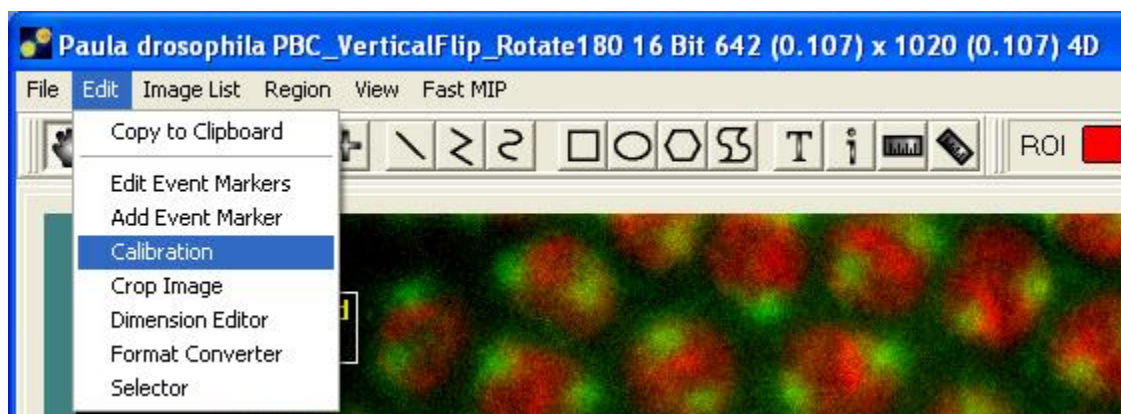

2.8.2.1 Copy to Clipboard

The **Copy to Clipboard** item allows the contents of the Image Window to be copied and pasted into other Windows applications such as Word, Paint, etc.

2.8.2.2 Edit Event Markers

The **Edit Event Markers** item enables the modification of image event markers.

The edit dialogue displays a text box containing the event marker name together with information identifying the dimensional location and associated frame number.

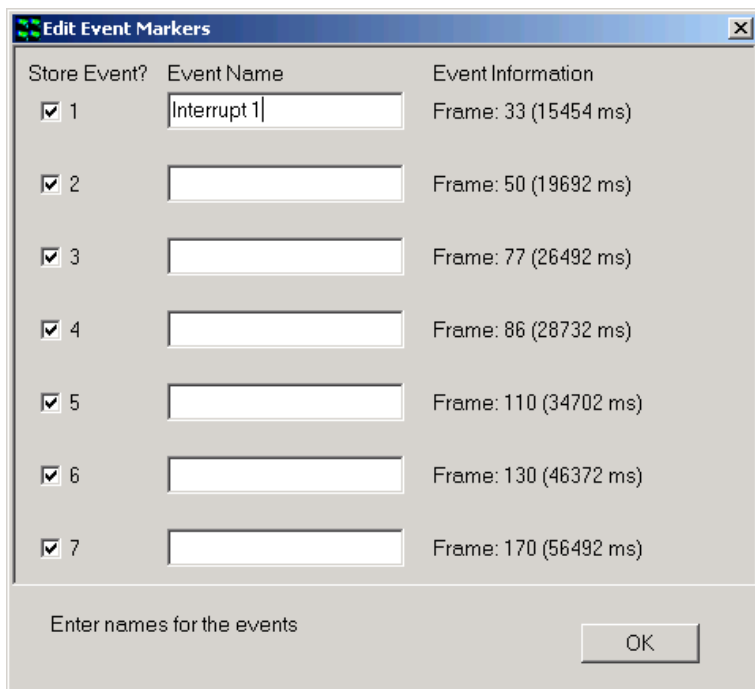

Event marker information is subsequently stored with the image by enabling the appropriate **Store Event** check box and exiting the dialogue by clicking on the **OK** button.

On exiting the dialogue, a message box is displayed prompting the user to confirm that events with no name are to be deleted from the list.

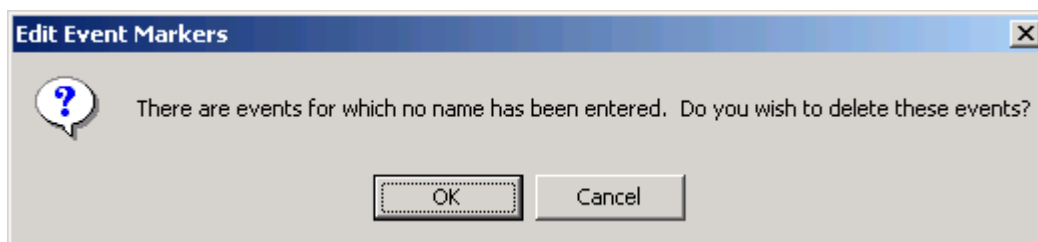

A revised event list following the removal of redundant is displayed below.

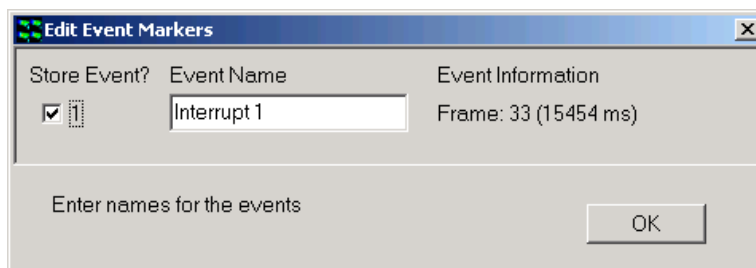

2.8.2.3 Add Event Marker

The **Add Event Marker** item allows additional image events to be added to the event list.

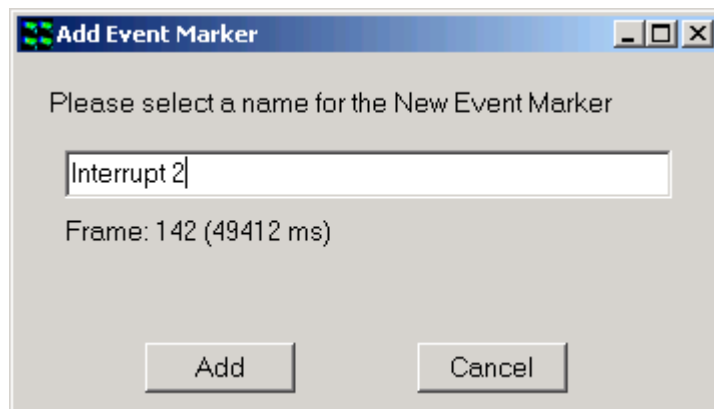

2.8.2.4 Crop Image

The **Crop Image** Tool is accessed from the Edit menu.

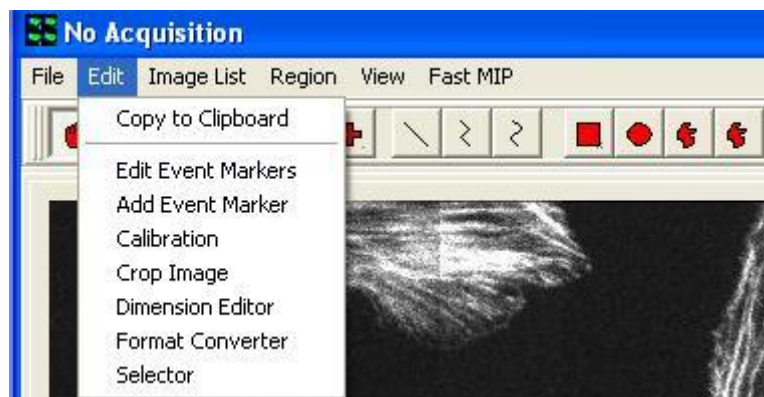

It is used to isolate regions of interest so subsequent processing and analysis need only be carried out on that ROI.

When Crop is selected it sets ROI class to a Crop type and then you can drag out a rectangular ROI for extraction. Crop works through all image dimensions.

2.8.2.5 Dimension Editor

The **Dimension Editor** is accessed from the **Edit** menu. Clicking on the selected item brings up the panel shown below.

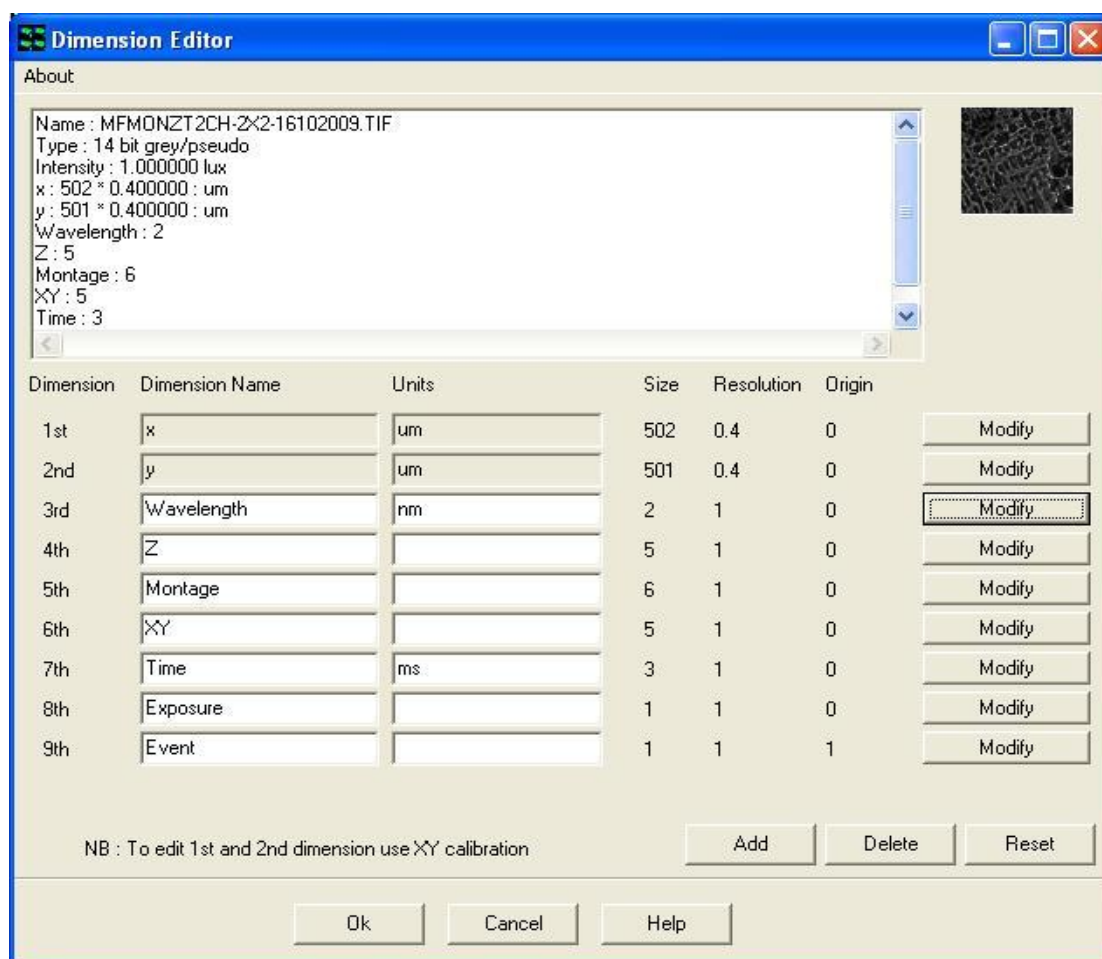
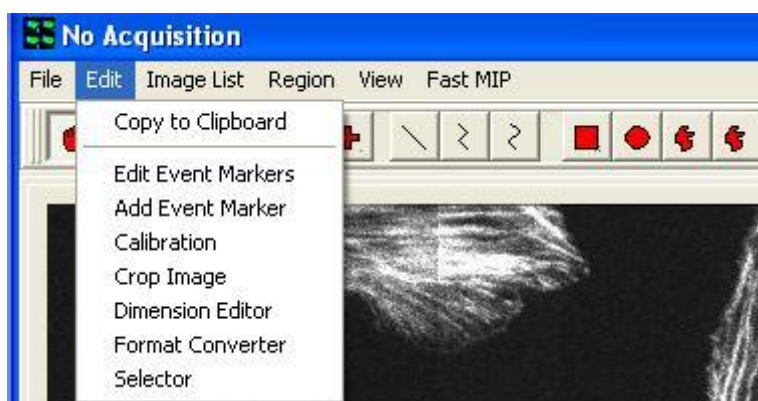

The Dimension Editor is used to change dimension names and units or to remove redundant dimensions from an image that is currently displayed in the Image Window.

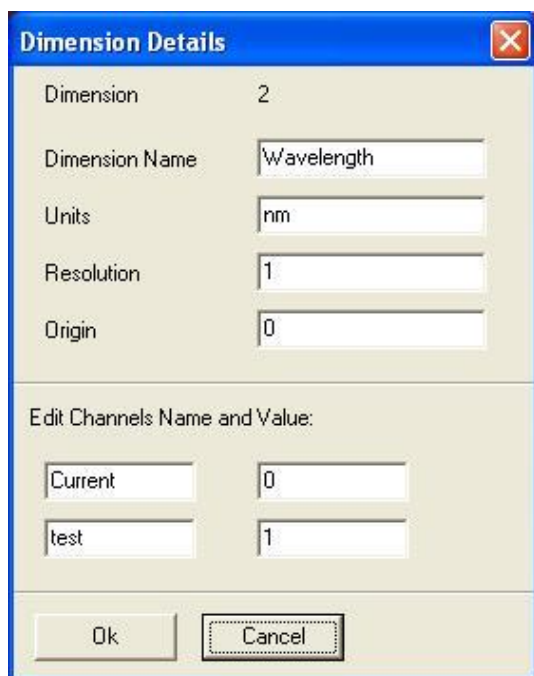

Dimension editor has a special function for Channels as shown left to edit Channel stamps and names. This can be useful in cases where wavelength stamps have been assigned the same value and then analysis cannot proceed. Changing the Stamps to different values will correct the problem.

After using the Multi-Load file opening tool, which defaults the 3rd dimension to time, you may wish to edit this for visualization or analysis purposes to Z, wavelength, etc.

A dimension is removed from the table by pressing the **Delete** button; the deletion process works sequentially such that the highest dimension in the list is removed first. For the example shown above, pressing the **Delete** button will remove the 8th and 9th dimensions from the list. The Dimension Editor panel following the deletion of all redundant information is shown below.

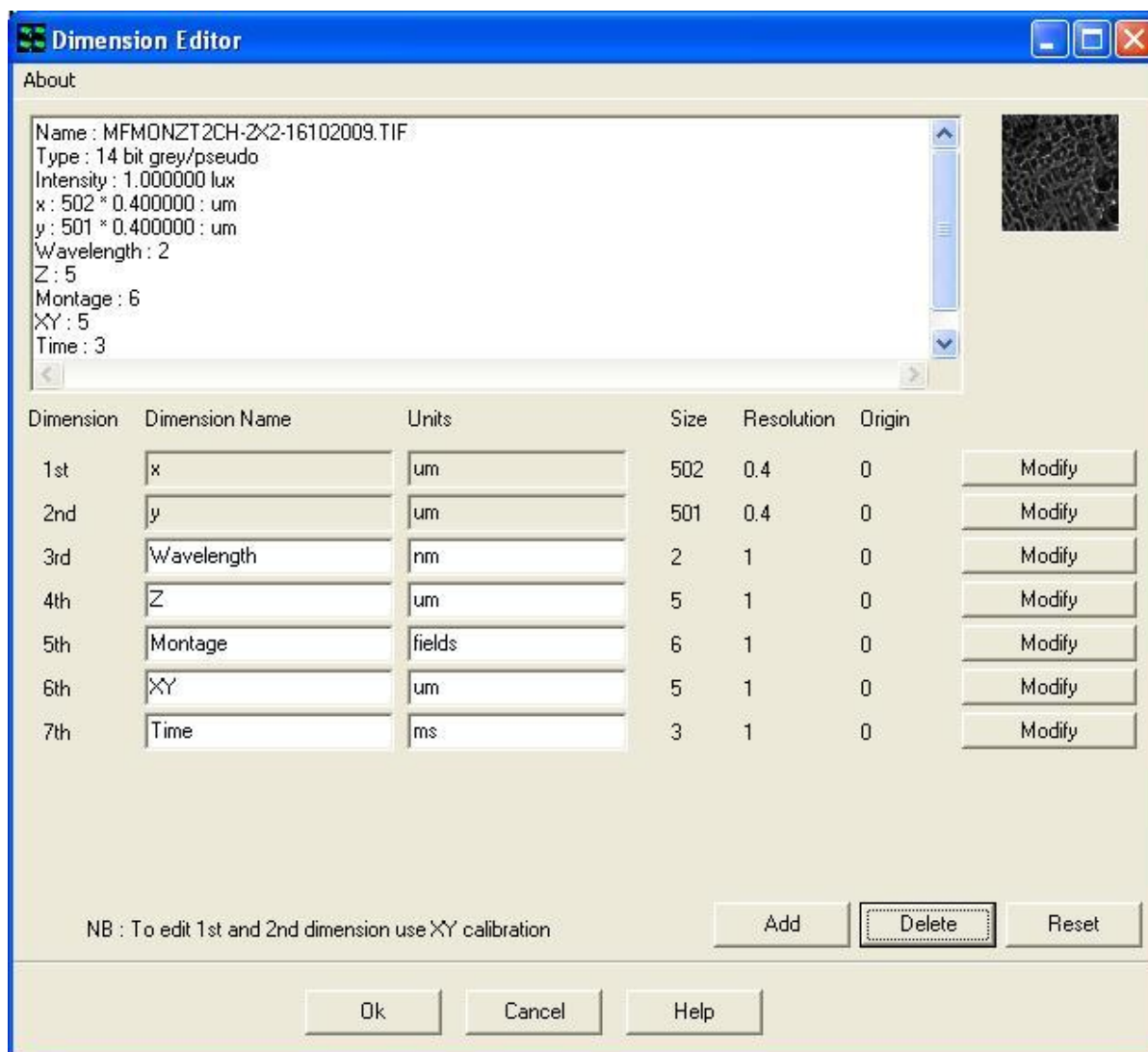

Dimensions may be added to the list by clicking on the **Add** button and completing the appropriate text boxes. This function is especially useful for correcting corrupted image data (e.g. where the Event dimensions may have been lost from an nDim series).

Modifications to the edit table may be cancelled by pressing the **Reset** button. Any changes made to the Dimension Editor are permanent and irreversible and are accepted by pressing the **OK** button. Pressing the **Cancel** button exits the edit panel without accepting any changes to the selected image.

2.8.2.6 Selector

The **Selector** is accessed from the **Edit** menu.

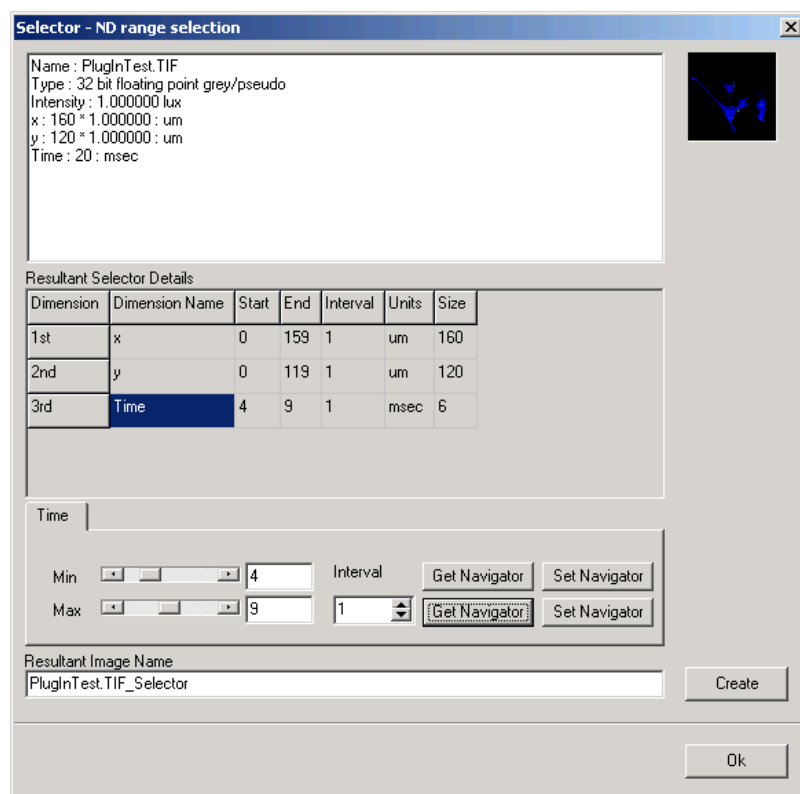

Clicking on the selected item brings up the panel shown on the left.

The Selector enables images to be sub sampled along any dimension, the resultant image copied to the Image List. However, the Selector has the benefit that it does not create a new copy of the data, but an “access filter”, which only operates on the specified frames. This makes it extremely efficient and fast to create.

In the above example, the image file PlugInTest.tif comprising twenty time frames has been sampled using the Selector to create an image file PlugInTest.tif_Selector comprising six time frames.

The Selector operates on the image currently displayed in the Image Window; the image details are displayed in the top panel of the Selector dialogue. The name of the image created as a result of the sampling process is shown in the **Resultant Image Name** text box. The image name can be defined by default (i.e. ImageName_Selector) or given a unique identification by typing a name into the text box.

The range of each dimension to be sampled is selected using the **Min** and **Max** slider bars. For the example shown, the resultant image will contain a total of six time frames. The first frame in the series is equivalent to a time of four milliseconds in the original data set; the last frame is equivalent to a time of nine milliseconds. The separation between frames during the sampling process is determined by the **Interval** parameter and may be adjusted using the spin buttons.

The Selector is linked directly to the Image Navigator and hence to the features displayed in the Image Window. Pressing the **Get Navigator** button records the position currently shown in the Image Navigator. This function can be used to adjust the position of the **Min** and **Max** slider bars.

Similarly, pressing the **Set Navigator** buttons updates the Image Navigator with the information represented by the position of the **Min** and **Max** slider bars.

The new sub sampled image is copied to the Image List by pressing the **Create** button. Clicking on the **OK** button exits the Selector tool, ignoring any changes to the Selector dialogue panel.

2.8.3 The Image List Menu

This opens the Image Manager, which displays all images in memory manager, together with image information. This has the same functionality as in the iQ Menus (**Section 2.6.2**).

2.8.4 The Region Menu

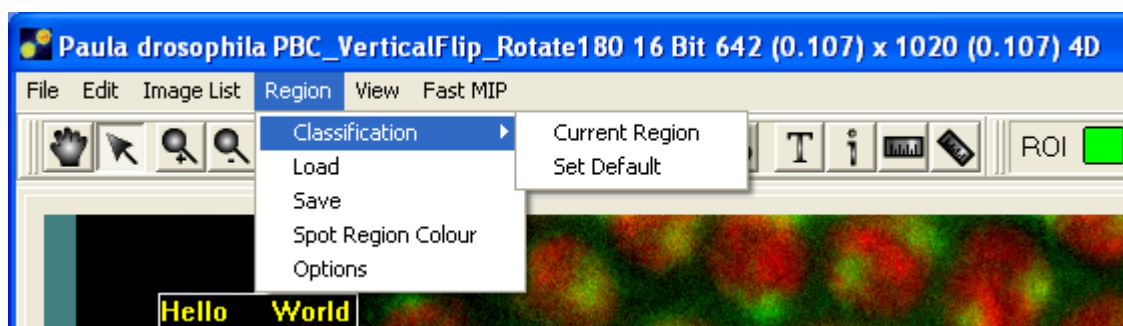

The Region menu item enables ROI's on the image to be assigned to a particular **Class** and to be saved to disk from where they can be subsequently reloaded.

Classification – this assigns the selected ROI to a particular class, the current ROI class is displayed in the Image Toolbar, as illustrated below. The ROI you wish to classify is selected by clicking on it using the Hand tool (**Section 2.10.1**) or the Pointer tool located in the Image Toolbar (**Section 2.10.2**).

Selecting the **Current Region** option opens the panel shown below.

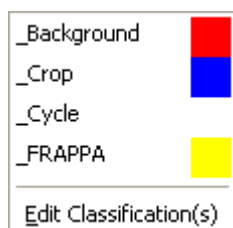

This enables the current ROI displayed in the image to be reassigned to any class in the definition list. Alternatively, the current ROI can be reassigned to a new class, created using the **Edit Classification(s)** function.

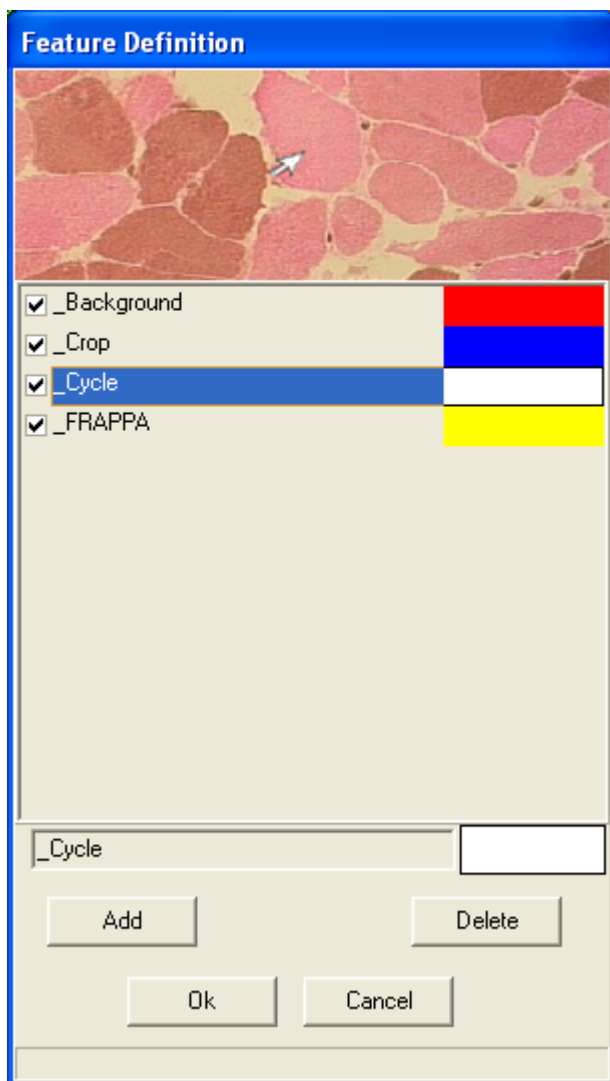

New classes can be created by clicking on the **Add** button or removed from the classification list using the **Delete** button. Pressing the **OK** button accepts any modifications to the ROI class list. **Cancel** exits from the classification editor, ignoring any changes that have been made.

The **Background**, **Crop** and **Cycle** features will be there by default and cannot be deleted. These are always assigned the color Red, Blue and White, respectively. Features must be assigned unique colors.

To add a feature, click on the **Add** button and the following dialogue shown below will be displayed.

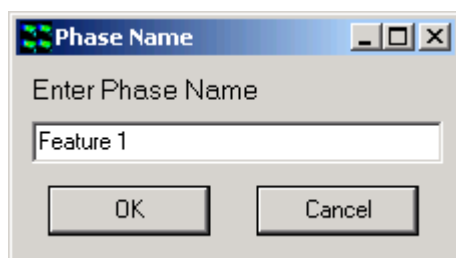

Enter a name for the new feature in the text box and press the **OK** button. Following the definition of a feature name a color for the feature can be selected from the color menu shown below.

Clicking on the **OK** button will add the new feature to the Feature Definition list

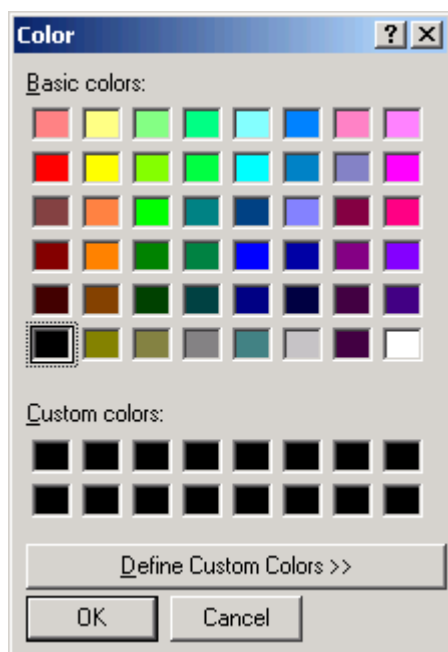

Features can be modified at any time by double clicking on the color box above the **Delete** button. A color palette will open from which you can select an unused color, then press **OK**. The palette will close and the color will be updated in the color box.

To delete a feature select it in the list so that its name is displayed in the text box, then select **Delete**. You cannot delete the Background feature. When you have added a new Class, in this case “Feature 1” it is added to the ROI list as shown.

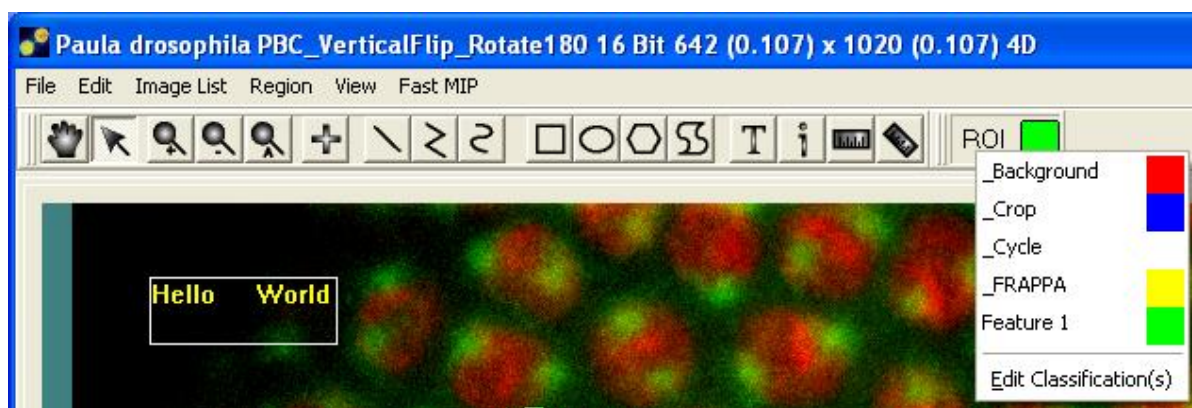

Selecting the **Set Default** option displays the panel illustrated below, allowing the current ROI to be reassigned to a new class. In the example shown the ROI class has been changed from Cycle to Feature 1 and the new class definition for the Current ROI is displayed in the Image Toolbar. Any new ROI(s) subsequently drawn on the image will be classified using the new default class.

Load / Save – load and save the ROI's.

The ROI positions and classes are saved to disk, from where they can be reloaded.

Spot Region Color – this enables the user to alter the color of the bounding

rectangles used to identify features analyzed during Spot Analysis. A comprehensive discussion of Spot Analysis is provided in **Section 4.10**.

Options – this allows the user to change the line width for drawing regions as well as the bitmap for drawing user-defined points.

2.8.5 The View Menu

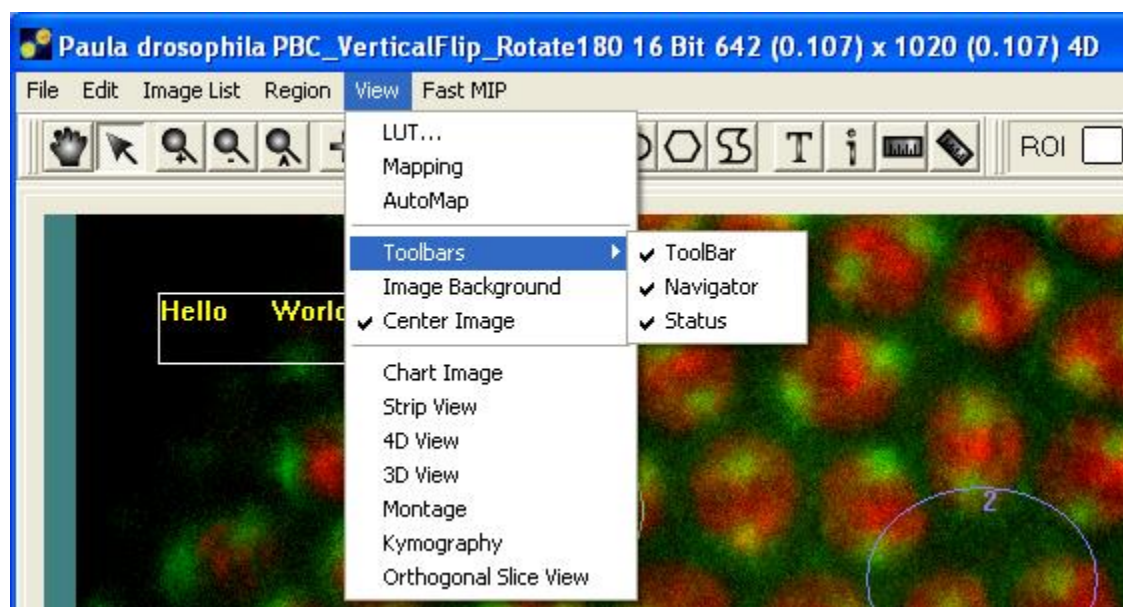

The View menu provides all the necessary tools for the display of images and features in the Image Window.

The **LUT** item allows the selection and editing of look up tables. Selecting the **Mapping** or **AutoMap** items accesses the necessary tools for the adjustment of image contrast and brightness. Please refer to **Sections 5.1.1 and 5.1.2**, respectively for further information.

Image Background – opens the image background color options. The Image Background item enables the background color of the image to be changed in order to improve visualization of image features.

Center Image – when checked locates the current image view in the center of the Image Window. When unchecked the image origin is located at the top left of the Image Window.

Chart Image (formerly) On-line Graph – opens an intensity real time plotting window for the whole image or a user defined area (**Sections 4.4.2.1 and 5.2**).

Strip View - opens the Strip View dialog where you can create a file strip type view which is useful for showing changing processes or Z planes on the printed page or when movie capability is not available.

4D View - opens up the 4D View Window to display a high quality volume rendered view of the current data. 4D View shares much functionality with Fast MIP, except that it renders the data set with higher quality at oblique angles.

3D View - opens up the 3D View Window to display a three dimensional view of the current image (**Section 5.3**).

Montage View - opens up the Montage Window and allows you to stitch images together into a large field of view after they have been acquired in montage or mosaic scan modes. Montage is sometime called mosaic or tiling images.

Kymography – Allows oblique and polyline slicing of time series and other multidimensional images (**Section 5.4**).

Orthogonal Slice View - opens up the Orthogonal View Window to display orthogonal slice views of the current image (**Section 5.5**).

Clicking on the **Toolbars** option displays the dialogue shown below.

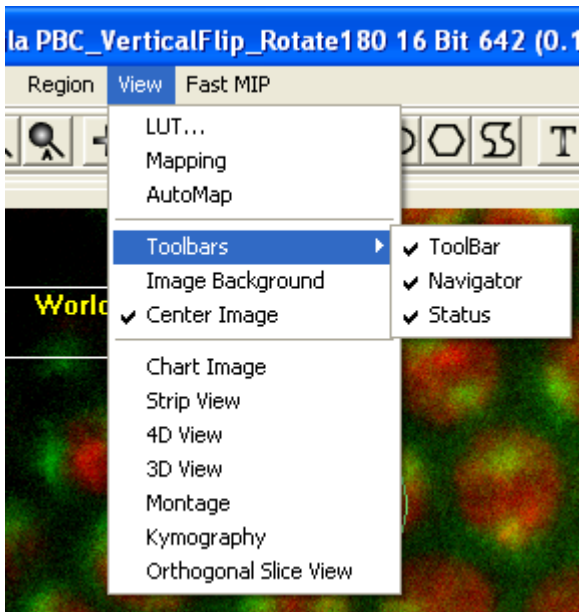

ToolBar - toggles the display of the Image Toolbar (**Section 2.10**), which is displayed above the Image Window. Please note that some of these icons can be repositioned as necessary.

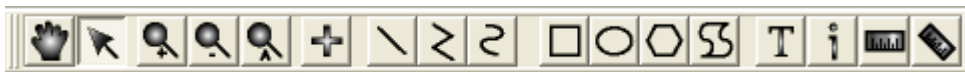

Navigator - toggles the display of the Image Navigator (**Section 2.9**), which is displayed below the Image Window.

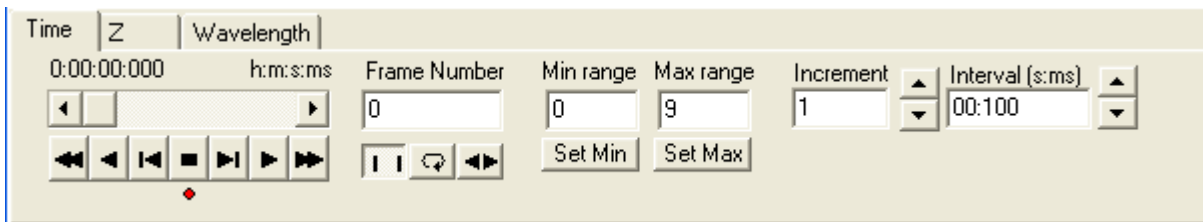

Status - toggles the display of the Image Window Status Bar, which is displayed below the Image Window.



2.9 The Image Navigator

The Image Navigator is displayed below the Image Window when Navigator is selected in the Image Window - Tools Menu. It is used to animate through multidimensional images, and to select frames of interest for analysis.

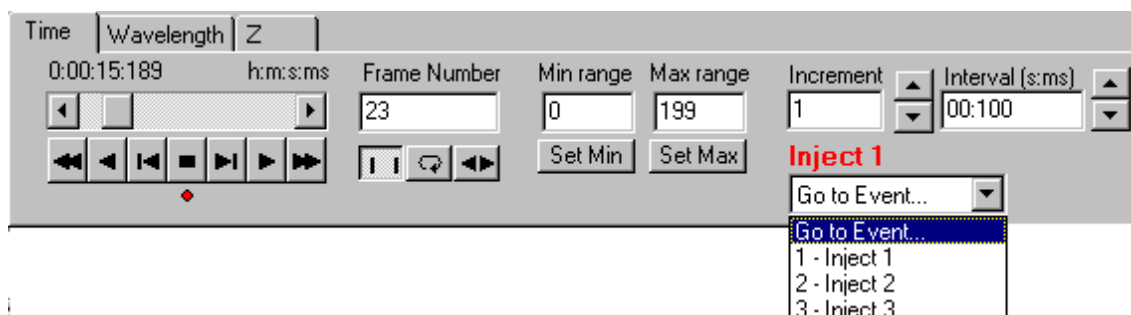



On top of the navigator shown above there are three tabs as Time, Wavelength and Z. These are the image's dimensionality tabs, whose number and name are determined by the displayed image. Selecting e.g. Time tab will display the information about this dimension, such as the number of frames along the dimension, and their respective time points. It also specifies the animation to be carried out along this dimension.

If the selected image dimension corresponds to Wavelength, this has an effect on the behavior of the Multi-Channel view function and hence the features displayed in the Image Window. The relationship between the Image Navigator and the Multi-Channel view is discussed in **Section 3.4.4**.





The nDim animation buttons are used to animate through the frames of an nDim:

 The **First Frame** button animates backwards through the nDim to the first frame.

 The **Play Backwards** button animates backwards through the nDim, one frame at a time.

 The **Jog Back** button is used to rewind the animation back one frame.

 The **Stop** button stops the animation.

 The **Jog Forward** button is used to advance the animation forward one frame.

 The **Play** button animates the nDim, displaying the changing x,y dimensions for each time frame.

 While the nDim is animating, the Play button label changes. Clicking on the button will **Pause** the animation, and change the button label back to Play.

 The **Final Frame** button animates forwards through the nDim to the final frame.

 When the **Normal Mode** button is selected, on animating the nDim with the **Play** button (forwards or backwards) it will animate through the frames of the image once and then the animation will end.

 The **Loop** button animates the nDim as does the Play button, but on reaching the end of the animation it repeats it, starting from the first time frame.

 The **Bounce** button continually plays the animation, forwards then backwards and so forth.



The scrollbar above the animation buttons can be used to scroll through the frames of an nDim. Simply drag the scrollbar with the mouse or click on the arrow buttons. The stamp value of the current frame is displayed above the scrollbar

When animating through an nDim, the number of the current frame is displayed in the **Frame Number** text box. This text box displays information only, values cannot be input.

When animating through an nDim, you may not wish to view every time frame in the image. It is possible to specify the frames for viewing, the remaining frames are ignored.

To select a sequence of frames, the number of the first frame in the sequence is selected in the **Min range** text box. Animate to the first frame in the sequence and press the **Set Min** button to accept the value.

The number of the final frame in the sequence is selected and displayed in the **Max range** text box. Animate to the final frame in the sequence and press the **Set Max** button to accept the value.

The **Increment** value is used to specify which frames to include in the animation. An increment value of one will animate through all frames, a value of 2 will display every second frame etc.

This value can be set either by pressing the arrow buttons or by typing a value directly into the text box.

The **Interval** is used to specify the speed of the animation, while navigating through an nDim. The time that each frame is displayed should be entered into the text box by pressing the arrow buttons.

If the image displayed contains Event Markers, these will also be reflected in the Image Navigator dialogue. For the example shown, three events are identified and labeled as Inject 1, Inject 2, and Inject 3, respectively. By accessing the **Go to Event** dropdown list it is possible to move directly to the location of the nDim series associated with a particular Event label. If the Navigator is positioned at an Event Marker, the marker label is displayed above the dropdown list as shown below.

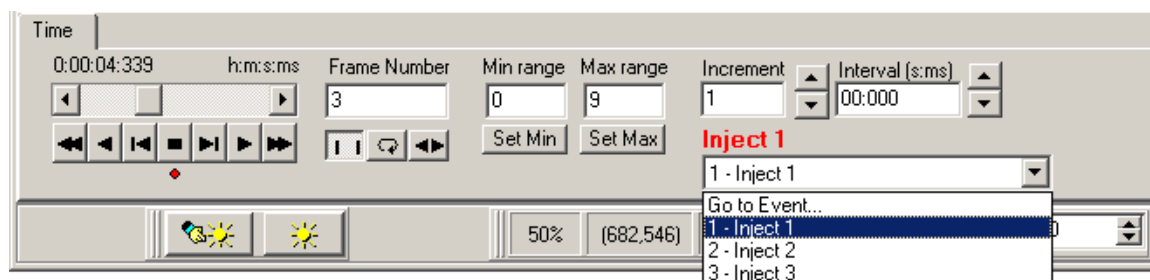

The Jog Left and Right buttons can now be controlled from the keyboard, by holding down CTRL and using the Left Arrow (←) and Right Arrow (→). This keys the frames to be played back and forth. Use the CTRL plus the Up Arrow (↑) Down Arrow (↓) to select the tabs in a multidimensional image.

2.10 The Image Toolbar

The Image Toolbar is only displayed when **ToolBar** is selected in the Image Window View Menu. It is used to define and manipulate Regions Of Interest (ROI's) on the image and to magnify the image view. The tool bar can be rearranged to fit the user's needs by holding down the left mouse button and dragging to the preferred location.

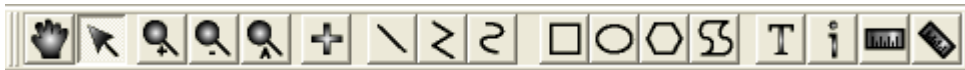

2.10.1 The Hand Button



If regions have been defined on the image using one of the region tools, the hand lets you select and move the region.

Right clicking on the image or a selected ROI will provide a popup menu.

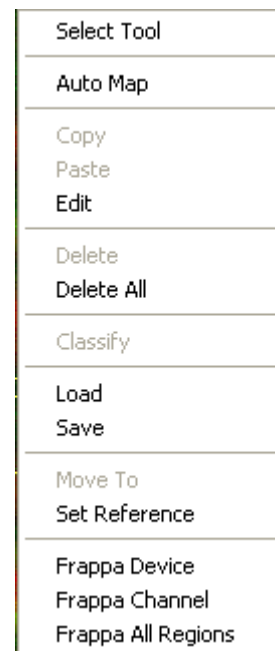

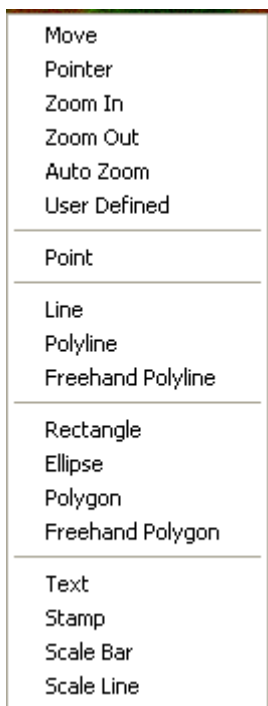

Select Tool - The **Select Tool** has its own menu. When selecting Select Tool the available options are shown in the picture on the left. This is a shortcut for accessing the options on the Image Window Tool Bar without recourse to the ToolBar itself.

Copy - Copy the selected region.

Paste - Pastes a region that has been selected with the Copy command. The pasted region will be identical in size, shape and class to the original region. It will overlay the original region, but can be moved using the Pointer button on the Image Toolbar.

Delete - Deletes the selected region from the image.

Delete All - Deletes all regions from the image.

Classify - Assign a color to the selected region. This is relevant when performing a Group Analysis (**Section 4.6**), in which results are calculated for all regions on the image in the same class (i.e. for all regions of the same color), as opposed to being calculated for each individual region.

Also with Group Analysis, regions in the same class will exclude overlapping areas from analysis. Regions can be drawn within regions to create holes and regions within holes to create islands.

Load/Save - The Feature Definition list (**Section 2.8.4**) can be saved to disk from where it can be reloaded, together with the position and class of all ROI's defined on the image.

Move To and Set Reference - If a motorized XY stage is currently under iQ control, then images acquired with iQ have stage coordinates attached in the Metadata. Using this information (and providing the stage has been registered or "sent home" with the Stage Registration wizard, then selecting **Move To** allows the image feature under the mouse to be brought to the center of the field of view. Thus when the user goes **Live** the feature will be visible. **Set Reference** allows the user to specify a different location on the screen to move the feature on **Move To**. An example where this is useful is with a **fixed laser beam** system, where features of interest are brought to the beam location for photo-stimulation.

FRAPPA Device - selects which device should be active for either interactive FRAPPA or Protocol FRAPPA actions.

FRAPPA Channel - specifies the Current FRAPPA Channel, not that FRAPPA Channels are specified in the **Select FRAPPA Wizard** as shown below.

FRAPPA All Regions - allows you to choose modes between FRAPPA the currently

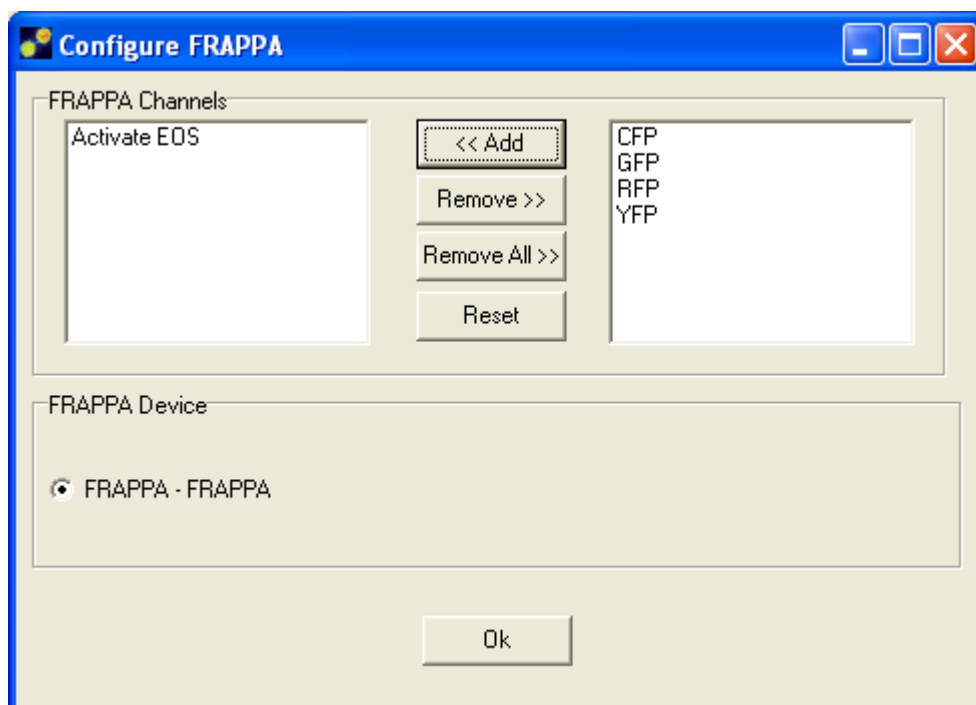

2.10.2 The Pointer Button



If regions have been defined on the image using one of the region tools, the **Pointer** button lets you drag, resize, delete, copy, paste and classify regions. Move the mouse over the image. When the cursor “passes over” a user-defined region it changes to a hand. Holding down the left mouse button and moving the mouse will drag the region to a new position. Release the mouse button to drop the region.

When the hand icon is at a corner or the middle of an edge of the user defined region it displays the sizing arrows. Holding down the left mouse button and moving the mouse will move the edge or corner in the direction of the arrow.

Right clicking on the image or a selected ROI will also bring up the same menus as discussed in **Section 2.10.1**.

2.10.3 The Zoom Button



The **+Zoom** button enables you to magnify the image displayed in the Image Window, enabling you to view the fine detail of features of interest more clearly:

When the Zoom Icon is selected, left clicking on the image will zoom in on the image, centered about the point clicked, whereas clicking on the image with the CTRL key held down will zoom out from the image, centered about the point clicked.

The Zoom Tool can be used in conjunction with the vertical and horizontal image window scrollbars, which enable you to zoom to higher magnifications and then scroll to the feature of interest.

The current magnification of the image is displayed in the text box below the Image Window, expressed as a percentage value:

50% - represents a half size image (one right mouse button click).

100% - represents a normal size image (no magnification).

200% - represents a double sized image (one left mouse button click).

Etc.

The **-Zoom** tool zooms out from the image without the need for the CTRL key.

2.10.4 The Auto Zoom Button



When selected, the image will be auto scaled into the image Window as shown below.

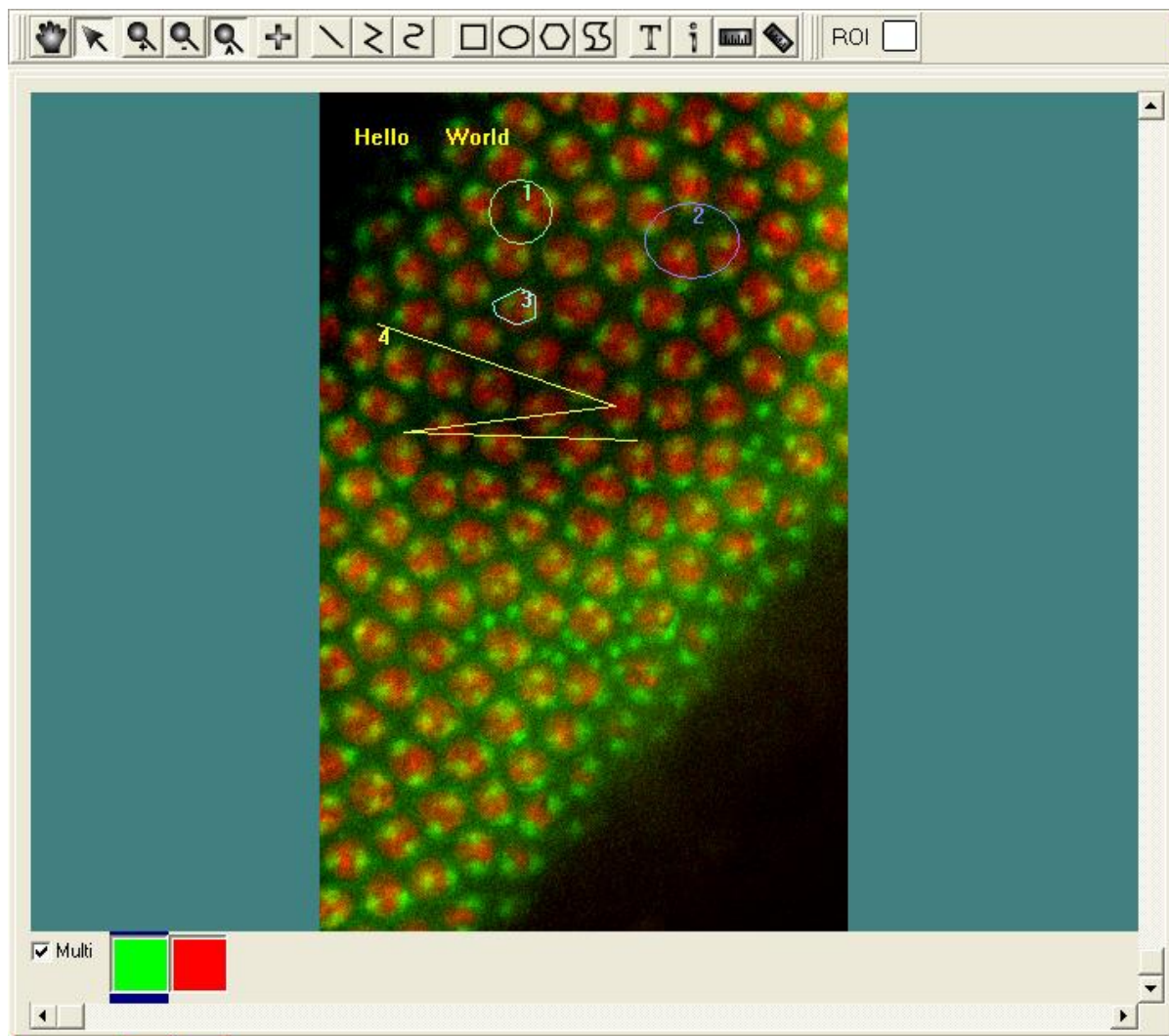

2.10.5 The Define Point Button

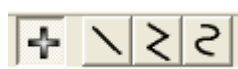

The **Define Point** button allows you to define specific point markers on the image window for reference. They will be assigned to the feature currently selected using the **Current ROI** button (**Section 2.10.17**) and will be drawn in the corresponding color. Point markers assigned to a feature are numbered sequentially, in the order that they are drawn on the image.

Position the mouse where you want to place the marker and click the left button, and the marker will be drawn in the image.

Right clicking on the image or a selected ROI will also bring up the same menus as discussed in **Section 2.10.1**.

2.10.6 The Define Line Button



The **Define Line** button allows you to define line regions on the image for analysis. They will be assigned to the feature currently selected using the **Current ROI** button (**Section 2.10.17**) and are drawn in the corresponding color. ROI's assigned to a feature are numbered sequentially, in the order that they are drawn on the image.

Right clicking on the image or a selected ROI will also bring up the same menus as discussed in **Section 2.10.1**.

2.10.7 The Define PolyLine Button



The **Define PolyLine** button allows you to define a user-defined line on the image for analysis. They will be assigned to the feature currently selected using the **Current ROI** button (**Section 2.10.17**) and will be drawn in the corresponding color. ROI's assigned to a feature are numbered sequentially, in the order that they are drawn on the image.

Click the mouse button at the either end of the line, and then click in turn to define the positions of all subsequent vertices. Click the right mouse button to complete the construction of the polyline.

Right clicking on the image or a selected ROI will also bring up the same menus as discussed in **Section 2.10.1**.

2.10.8 The Define Freehand PolyLine Button

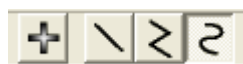

The **Freehand Polyline** button will allow you to define a user-defined region on the image for analysis. They will be assigned to the feature currently selected using the **Current ROI** button (**Section 2.10.17**) and will be drawn in the corresponding color. ROI's assigned to a feature are numbered sequentially, in the order that they are drawn on the image.

Click the mouse button at the position of the first vertex of the line, and then drag the

mouse on the image to define the rest of the line structure. Right click to end the construction of the polyline.

Freehand Polyline regions can be moved and deleted with the **Hand** or **Pointer** button, but cannot be resized. Right clicking on the image or a selected ROI will also bring up the same menus as discussed in **Section 2.10.1**.

2.10.9 The Rectangle Button



The **Rectangle** button allows you to define rectangular regions on the image for analysis. They will be assigned to the feature currently selected using the **Current ROI** button (**Section 2.10.17**) and will be drawn in the corresponding color. ROI's assigned to a feature are numbered sequentially, in the order that they are drawn on the image.

Position the mouse where you want to place the top left corner of the rectangular region, and holding down the left mouse button, drag the mouse to the bottom right corner of the region and release the button.

Regions can be moved, resized and deleted with the **Hand** button or the **Pointer** button (**Section 2.10.1 and 2.10.2**). Also, right clicking on a selected ROI will also bring up the same menus as discussed in **Section 2.10.1**.

2.10.10 The Ellipse Button



The Ellipse button will allow you to define ellipsoid regions on the image for analysis. They will be assigned to the feature currently selected using the Current ROI button (**Section 2.10.17**) and will be drawn in the corresponding color. ROI's assigned to a feature are numbered sequentially, in the order that they are drawn on the image.

Position the mouse where you want to place the top left corner of the ellipsoid, and holding down the left mouse button, drag the mouse to the bottom right corner and release the button.

As with the Rectangular regions, ellipsoid regions can be moved, resized and deleted with the **Pointer** or **Hand** button. Right clicking on the image or a selected ROI will also bring up the same menus as discussed in **Section 2.10.1**.

2.10.11 The Polygon Button



The **Polygon** button will allow you to define a user-defined region on the image for analysis. They will be assigned to the feature currently selected using the **Current ROI** button (**Section 2.10.17**) and will be drawn in the corresponding color. ROI's assigned to a feature are numbered sequentially, in the order that they are drawn on the image.

Click the mouse button at the position of the first vertex of the polygon, and then click in turn to define the positions of all subsequent vertices. Click the right mouse button to complete the construction of the polygon.

Polygon regions can be moved and deleted with the **Pointer** or **Hand** button, but not resized. Right clicking on the image or a selected ROI will also bring up the same menus as discussed in **Section 2.10.1**.

2.10.12 The Freehand Polygon Button



The **Freehand Polygon** button will allow you to define a user-defined region on the image for analysis. They will be assigned to the feature currently selected using the **Current ROI** button (**Section 2.10.17**) and will be drawn in the corresponding color. ROI's assigned to a feature are numbered sequentially, in the order that they are drawn on the image.

Click the mouse button at the position of the first vertex of the polygon, and then drag the mouse on the image to define the rest of the polygon. Right click to end the construction of the polygon.

Freehand Polygon regions can be moved and deleted with the **Pointer** or **Hand**

button, but cannot be resized. Right clicking on the image or a selected ROI will also bring up the same menus as discussed in **Section 2.10.1**.

2.10.13 The Define Text Button



The Define Text Button will allow the user to insert text onto an

image. After selecting the Define Text button use the left mouse button to define the upper left hand of a box and drag mouse until box is the necessary size. Release mouse button. Right click on box and select **Edit**. The Region Details dialogue box will appear allowing the user to change the size of the box, select a ROI Classification, change the font, and enter a message.

Select the Ok button to continue.

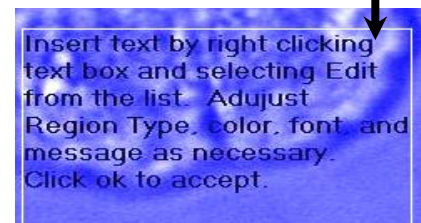

2.10.14 The Information Field Button



Selecting the Define Stamp Field Button brings up the menu seen on the right. Select the item from the list to insert and use the right

mouse button to drag a box on the image. Release the button to complete. The selected stamp will appear in the drawn box.

Right clicking on the image or a selected ROI will also bring up the same menus as discussed in **Section 2.10.1**. To edit the stamp, select edit and the user can select

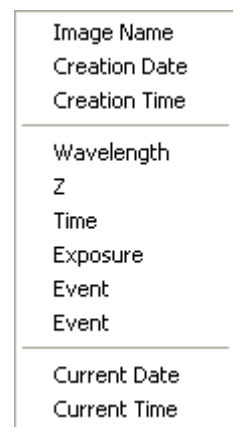

2.10.15 The Define Scale Bar Button



Scale bars can be drawn on the image with measured length readout in Euclidean distance –point to point.

2.10.16 The Define Scale Line Button



Scale lines can be drawn on the image with measured length readout in Euclidean distance –point to point as shown below.

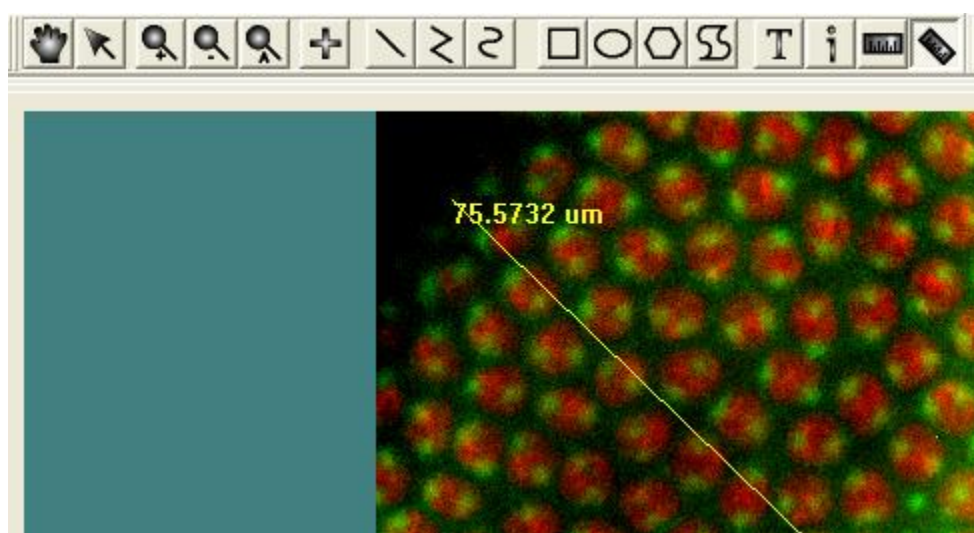

2.10.17 The Current ROI Button

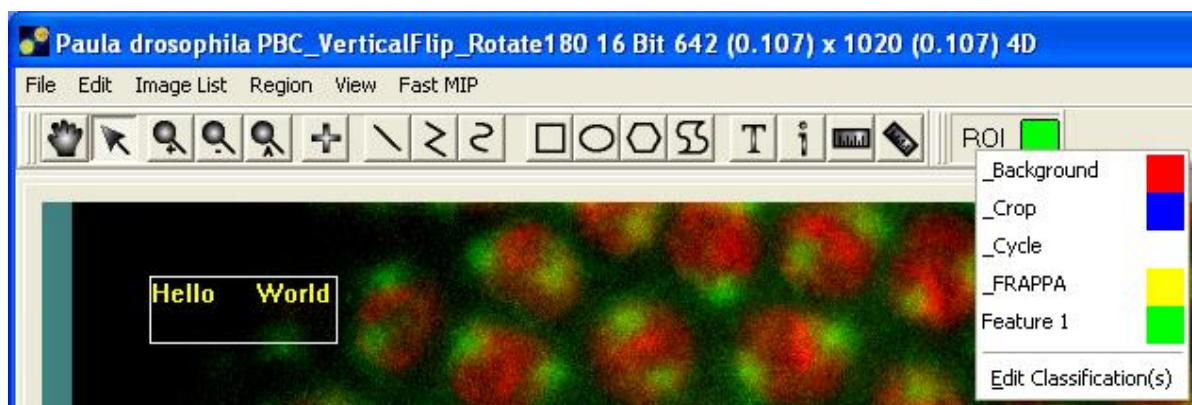

A mouse click on the Current ROI button enables the current ROI displayed in the image to be reassigned to any class in the definition list. Alternatively, the current ROI can be reassigned to a new class. The creation and classification of ROIs was described previously in **Section 2.8.4**.



3 - Calibration and Alignment Tools

3.1 Wizards - Help Setting up Your Imaging System

Andor iQ can be configured to control a wide range of hardware for many applications. Not surprisingly, we strongly recommend that you setup your hardware carefully in iQ before you use it for research imaging. To help you we have created a number of Wizards for calibration of the system camera(s) and other devices such as microscopes, motorized stages and photo-bleaching and activation devices. Many of these Wizards are outlined in this chapter, and while we understand your desire to “leap in”, it will serve you well to follow the relevant steps below to obtain the best performance from the software and imaging system.

The **Wizards** are accessed via the iQ 1.X Wizard menu and listed here together with the hardware they are designed to support and sections in this chapter in which they are described.

- **Calibration** – Camera pixel, microscope objective and C-mount adapter – basic requirement for real measurements in images. See section 3.2.
- **Stage Registration** – iQ tries to send the stage to its coordinate origin (this step is explained in section 3.2) and is used to ensure that iQ can reproduce stage positions from coordinates stored in previous sessions. It is a basic tool to allow re-use of scan patterns. So if you try to cancel at start-up, iQ will keep reminding you until it is completed for your current session.
- **DSD Calibration** – Andor’s Differential Spinning Disk (DSD) is a spinning disk, structured illumination system with optical sectioning capability. In other words, it is a confocal scanner which uses computer image processing to achieve optical sectioning. The calibration procedure for this device ensures precise alignment of two images of the specimen and should be executed daily or whenever a filter turret is changed. See section
- **Select XYZ Device** – in some configurations multiple XY or Z devices might be present – e.g. there may be a piezo Z as well as a microscope

motorized focus. This wizard allows you to specify which device iQ should control for Z scanning. It is important for performance and range reasons – a piezo will provide fast control over small movements (100's microns), while a motorized microscope focus will provide relatively slow control over a much wider range (millimeters). The same comparison is true for other axes - piezo XY and stepper motor XY stages can co-exist. In order to manage multiple z devices, iQ 2.1 introduced what we refer to as “Reference Z” and “Scan Z”. “Reference Z” represents the slower more course Z device, such as a microscope Z motor. It is used to associate a Z position with XY movements. “Scan Z” represents the faster, fine changing Z device. It is used for scanning through a series of z positions. This wizard allows you to select the device associated with each of these. You can use the same device for both Reference Z and Scan Z.

- **Camera Alignment** – This allows you to co-align two cameras, and in combination with the Field Split plug-in allows for co-alignment of data from two cameras. This Wizard is described in section 3.4 along with the **Field Split** for dual camera systems. More details on Field Split for single camera use is provided in Chapter 5.
- **Stage Alignment** – Camera and motorized stage orientation and motion alignment – necessary for correct montage and multi-well or micro-plate scanning. Follow the details in section 3.5.
- **Select FRAPPA Device** – Choose which Channels are FRAPPA channels to help iQ identify their special needs. Note in general iQ 1.X only controls the laser combiner and FRAPPA scanner in these Channels.
- **FRAPPA Calibration** – FRAPPA calibration helps you create a correspondence between the camera pixel positions and the FRAPPA scanner angular positions. This allows you to bleach and activate user-

specified ROIs. See section 3.6 for a description of FRAPPA and FRAPPA calibration.

- **Channels** – the Channel wizard helps you set up and record the state of all the instruments in the system to acquire images for specific modalities or fluorophores e.g. DIC, epi-EGFP, CSU-mCherry, TIRF-CFP. More details can be found in section 3.6. Please note that the exact sequence and form of the Wizard depends on the devices you have configured in your system, so you need to extrapolate from the examples to your specific configuration.
- **Scans** – Scan Wizard provides tools for defining XY and Z scans ranging from simple multi-point or multi-field scans to micro-plate or multi-well patterns typically used in multi-treatment screening experiments. In addition the user can include a Z range, with or without Autofocus and montage (or mosaic) patterns can be recorded around the field centers in cases where an extended field of view is required.
- **Protocols** – the Protocol wizard helps you set up and record the channels and scanning patterns, repetition and timing of multi-dimensional image acquisition sequences. See sections 3.8, 3.9 and 3.20

3.2 Calibrate Your System

IMPORTANT: Before you use Andor iQ to capture or analyze images, you should calibrate the system. If your system has a motorized stage then you should also complete **Stage Alignment** in order to ensure that scan patterns are accurate and in the correct orientation. Careful attention to this process will help to yield the best results.

For **multi-camera** systems and **field splitting** devices, for simultaneous multi-channel imaging, calibration tools are accessed from the Wizards menus.

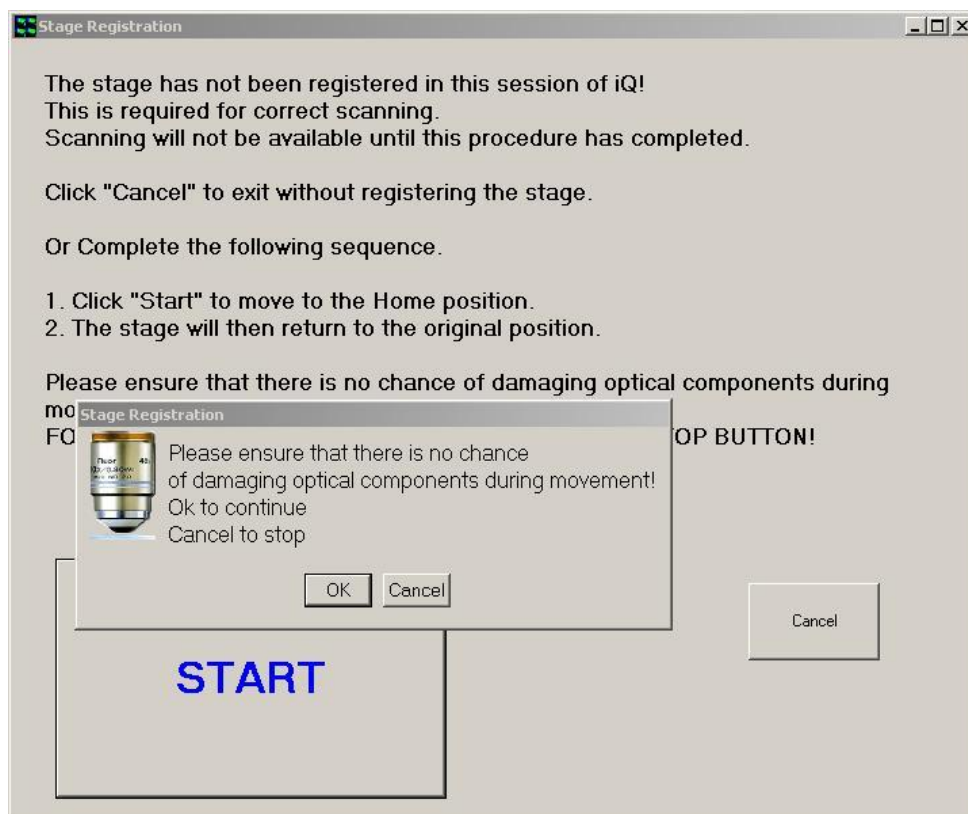

NOTE: If your system has a motorized stage then you will see the dialog above when the system starts up (if the stage has been moved or powered off between sessions). Make sure you lower the objective lens to avoid damage and allow iQ to calibrate your stage. This will ensure your scan patterns are repeatable.

Andor iQ has a **Calibration Manager** which provides two modes to calibrate camera pixel and system optics to specimen dimensions for quantitative analysis.

The first is **Automatic** and relies on knowledge of the optical magnifications in use and the pixel size of the camera chip. We will briefly describe this mode here. The second is **Interactive** and requires use a calibration device such as a graticule or haemocytometer with the selected objective.

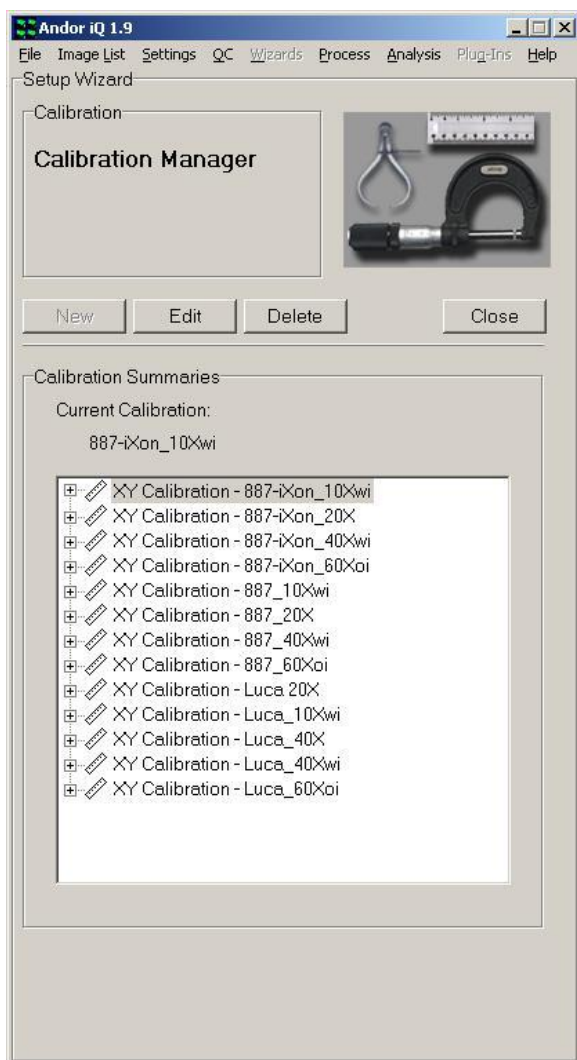

The Calibration Manager guides you through creating calibrations. It is opened by pressing the **Calibration Manager** button on the Calibration XY tab, or selecting **Calibration** from the **Wizards menu**.

Here we show the Calibration Manager with an existing set of calibrations for two cameras and a range of objectives.

From this dialog you can create (**New Button**), **Edit** and **Delete** calibrations. Click the **New** button and you will see 2 options pop-up – choose **Automatic** if you are sure of your scope and **C-mount magnification**. Choose **Interactive** if you are unsure. **Either way the Wizard will guide you**. Here we illustrate the Automatic method.

Please note that the “Default” calibration present when the system is first run cannot be deleted. It is replaced on the creation of a new calibration file.

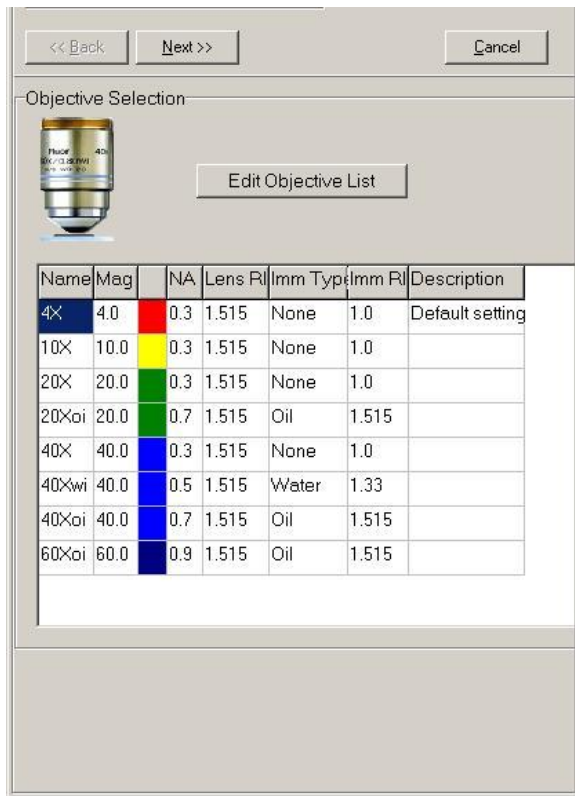

You should create a new Calibration set when you first set up your system, add a new camera (if it has different size pixels) or if you add an objective to the system.

This panel here, lists the objectives in use in your system. iQ populates a default list, but you should edit the list to reflect the objectives in your system by selecting **Edit Objective List**.

Note that the colors used with each objective ease identification and reflect the standard colors used by all manufacturers on objective bodies.



- In the **Edit Objective List** dialog you can
- i) Edit the objective settings with the **Edit** button (a new dialog allows you to enter description, NA, immersion medium and refractive index properties).
 - ii) Extend the list by **Add** - a new dialog will provide a list of objectives magnifications from which you can choose and then edit for the specific properties of your objective.
 - iii) Make sure you **Remove** objectives that are not installed on your system to avoid confusion for users.

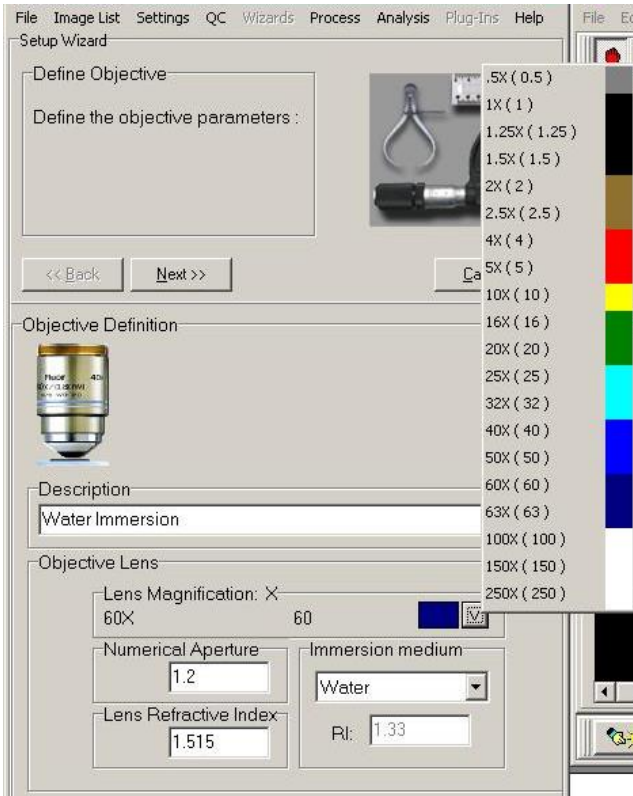

Here you see the **Add Objective** dialog. Complete the description box, set the NA, Lens RI (defaults to glass 1.515) and the immersion medium (air, water or oil) and Select the objective magnification from the list that iQ pop-up when you click on the button to the right hand edge of the Lens Magnification box, which is highlighted with an ellipse in this figure.

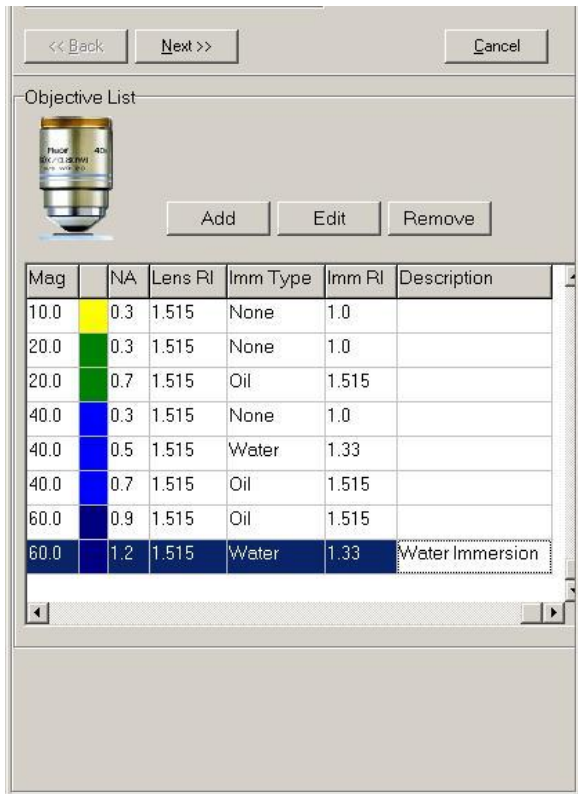

When you click **Next** you return to the Edit Objective List dialog and the new objective is added to the list. Repeat this sequence until you have completed your list. Once the list is complete click on the Next Button and you will then be shown the **Camera List** box.

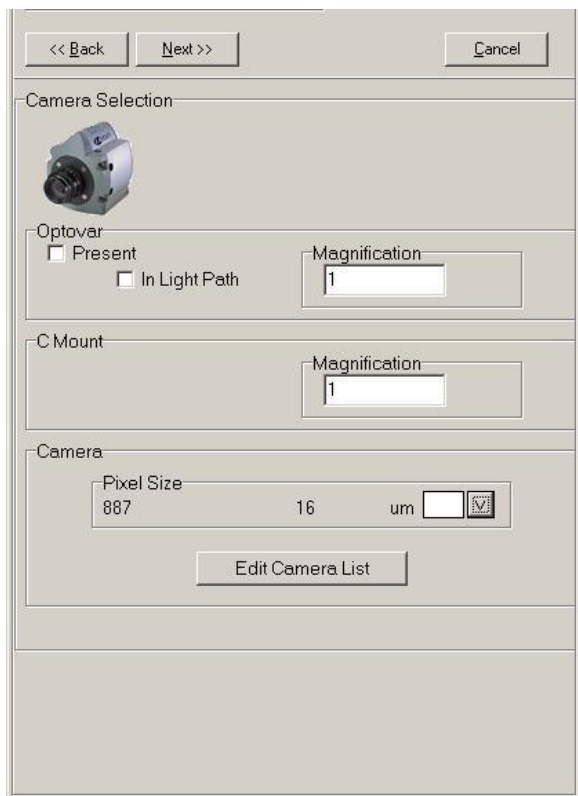

The **Camera** dialog shows the currently selected camera – in this case an Andor **iXon 887**. At this stage if there are no other cameras in use then you simply specify whether you have an **Optovar** in the system – optional additional magnification lens following the objective. This is mounted on a slider and can be pushed in and out of the optical path. iQ provides a check box to specify whether in use or not. You also define here if you have a **C-mount** adapter with a magnification different from 1X.

You can add cameras to the by clicking on **Edit Camera List** button. iQ will show this dialog. You can enter a Name/description in the **Alias** box and then select a camera from the list iQ provides. We suggest that you keep the alisa short because it is used to name the calibration setting in conjunction with the magnification of the objectives chosen. When you click on the down arrow box, highlighted with a circle here, the list of cameras supported in iQ is automatically populated by iQ, along with their pixel sizes.

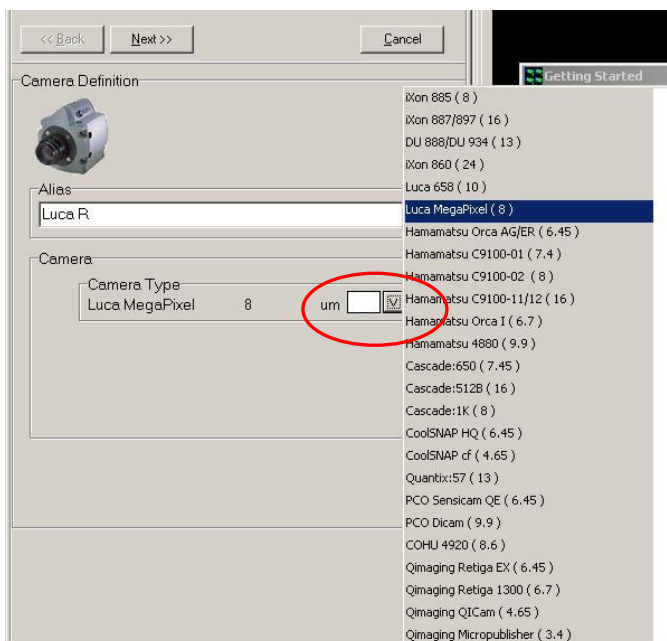



Now you have a list of cameras, as shown here, and you can complete the Calibration process with one more click on **Next**.



Here is the updated calibration list we have created. In this case we chose the 887 as our camera in use.

3.2.1 Binning

Binning is not fixed in the calibration settings. The calibration settings are automatically adjusted to reflect the binning chosen during acquisition.

3.3 Differential Spinning Disk (DSD) Calibration Wizard

The Andor Revolution DSD is a spinning disk structured illumination microscopy scanner or SD-SIM. Because it uses a structured illumination technique, it requires computer processing of two image halves to create a single confocal or epifluorescence result. The image processing required is simple enough, either weighted addition or subtraction, but in order to obtain high quality results the images must be very closely aligned e.g. 0.1 pixels. The DSD Calibration Wizard is described in section 3.3.2.

3.3.1 DSD and SD-SIM Principle of operation

The DSD is the first confocal instrument to successfully deliver high-performance confocal imaging using a cost-effective white-light source rather than lasers. The differential spinning disk (DSD) scanner can provide multifluorophore imaging from a single light source at a cost substantially lower than laser scanning instruments. However, unlike previous white-light systems, DSD performance is comparable to that of point scanning systems, but with higher speed and lower photobleaching.

DSD is competitively priced and uses a patented optical detection principle known as “aperture correlation” to reject out-of-focus light. Key benefits of the DSD scanner include frame rates up to 10 times those of most point scanning systems; optical sectioning with objectives ranging from 10x to 100x; operation with many fluorophores by selection of appropriate filters; and, as will be discussed, acquisition of confocal and epifluorescence images simultaneously.

In a DSD system, the spinning element comprises a single synthetic quartz disk supporting a thin layer of aluminum in which the structured illumination pattern (SIP) is created by photolithography. The aluminum SIP has a 1:1 mark to space ratio (half metal and half space), which means that approximately half of the light falling upon it is reflected (R) and half transmitted.

The disk is located at an image plane of the microscope optical system, so that an image of the SIP is projected into the specimen, and about half of the illumination

intensity arrives at the specimen while the remainder is reflected back into the illumination pathway, where it is baffled to minimize background. In the detection pathway, the resulting fluorescence signal comprising what is in focus (confocal, or *C*) and out of focus (wide field, or *W*) is imaged back onto the disk, where we make use of its transmissive and reflective properties.

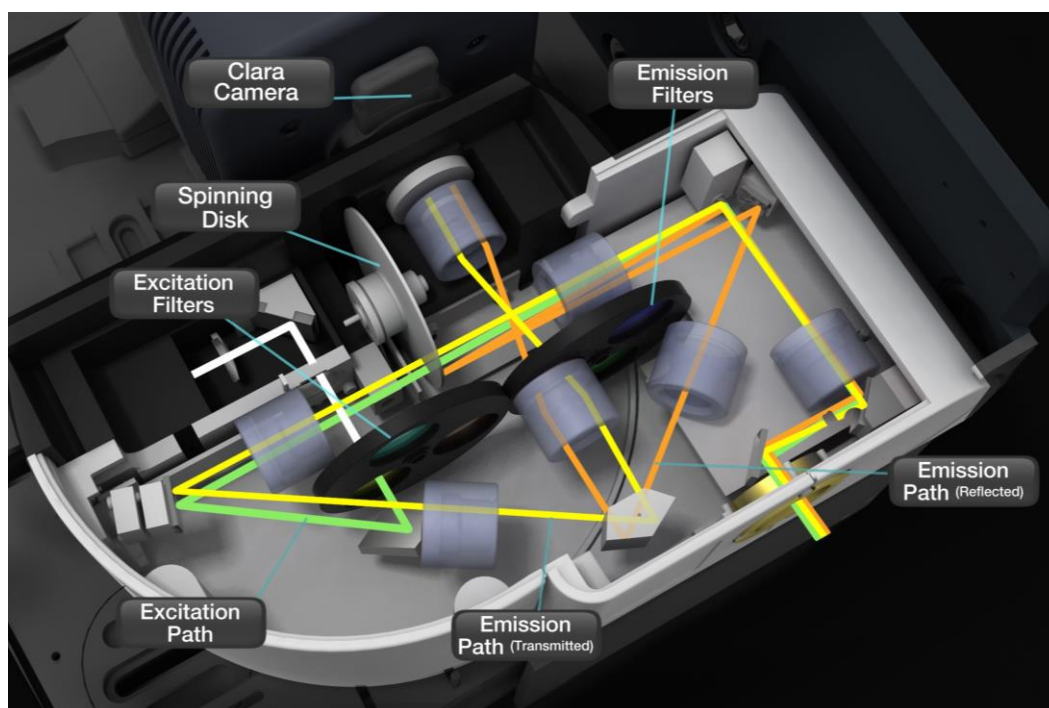

The fluorescent light transmitted by the DSD disk comprises the *C* signal plus about half of the *W* signal, while the light reflected from the disk comprises about half of the *W* minus the *C* signal. In confocal terminology, the SIP is located in a conjugate image plane and hence acts as both the confocal source and detection apertures. However, as it is not a pinhole, we must undertake some further image processing to separate confocal and wide-field signals. The optical path is illustrated in Figure above - green is the excitation path and yellow and orange the fluorescence transmitted and reflected paths respectively.

From the description above, we can see that the transmitted and reflected signals can be approximated as follows:

$$T = 0.5 W + C; R = 0.5 W - C, \quad (\text{Eq. 1})$$

and simple algebra shows us that

$$2C = T - R; W = T + R. \quad (\text{Eq. 2})$$

As Equation 2 highlights, we need to collect both transmitted and reflected light signals (images) to compute the confocal signal. Furthermore, we can easily compute the wide-field (conventional epi-fluorescence) signal as well as the confocal. The figure below shows how the T and R images are projected onto the CCD detector - transmitted image, T on the left and reflected image, R on the right.

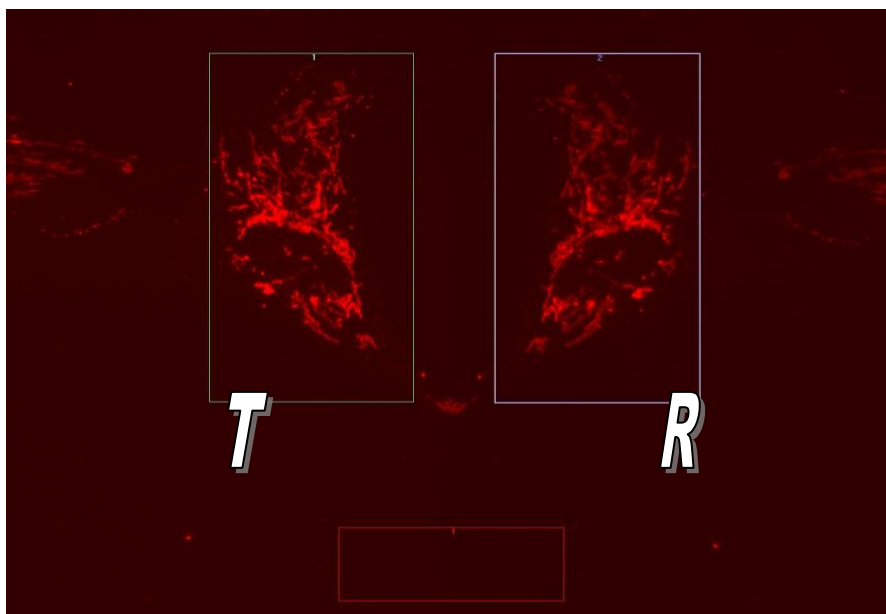

The simple mathematics of Equations 1 and 2 hide one complexity in the principle of the DSD; i.e., the *T* and *R* images must be very well-registered for the calculations to provide high-quality images. Any misalignment between the two will result in registration noise, so an essential feature of image processing for the DSD is a high-performance, real-time registration algorithm. The DSD Calibration wizard delivers the parameters needed for the algorithm to be successful.

3.3.2 DSD Calibration Wizard

The DSD has an internal calibration mask which can be switched into the imaging path and used as a reference pattern to align the two image halves projected onto the image sensor. The calibration mask pattern has a unique high contrast pattern to ease image matching and the *T* and *R* images of the pattern follow the same optical paths as the *T* and *R* images from a real specimen. Consequently the pattern

images are distorted in exactly the same manner. The distortion is wavelength dependent and so the registration algorithm is applied at all filter positions and parameters stored so that they can be applied during image capture based on the filter combination in use.

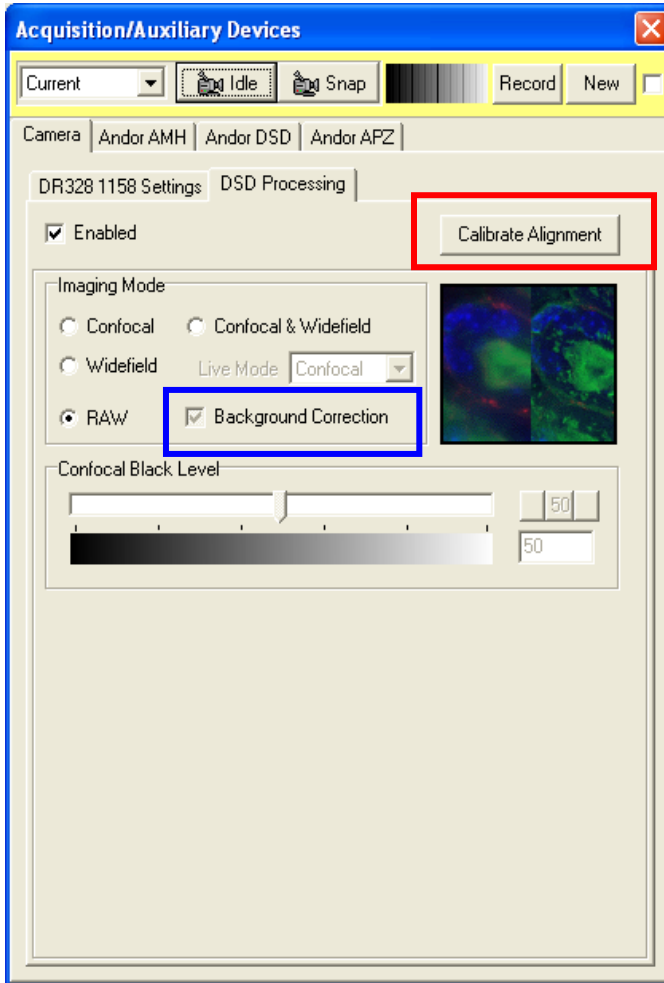

The DSD calibration wizard also measures the background signal (or image) for each wavelength, with the light source in the correct state and filter position. So the wizard corrects for optical distortion and background to provide the best quality result with the widest dynamic range.

The Wizard executes automatically from a single button click on the Camera user interface as shown left. Simply click on the “Calibrate Alignment” button highlighted in red. Note you can select and deselect the Background Correction option by clicking on the blue highlighted checkbox. The only reason to

deselect is for reasons of speed as the process adds about 90 seconds to the Alignment step of about 2 minutes.

When the wizard is running it shows you a progress dialogs as shown below for Registration and Background.

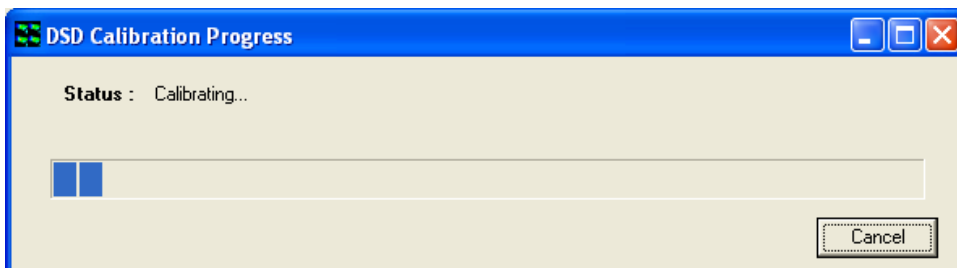

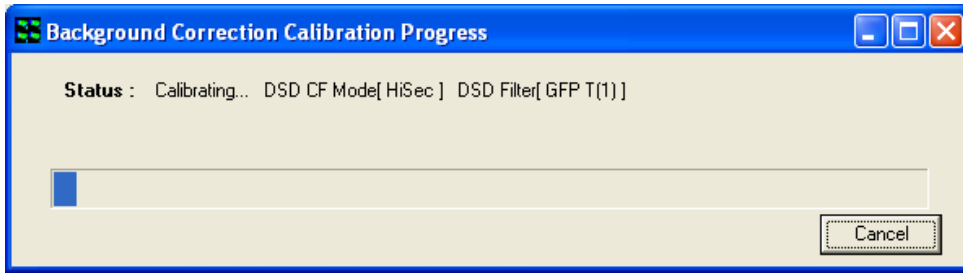

The DSD calibration Wizard should be run each day before starting work - the system will remind you if you do not do this. The wizard should also be run whenever a filter turret is changed. A filter turret change Wizard is also available from the Wizard menu or the DSD device control tab as shown below. Note that Andor DSD turrets (shown below) can be switched with the DSD attached to the microscope.



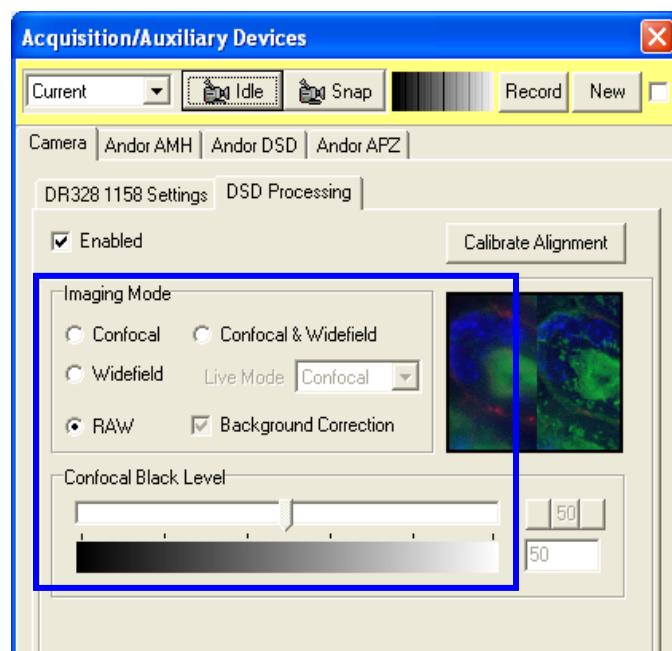
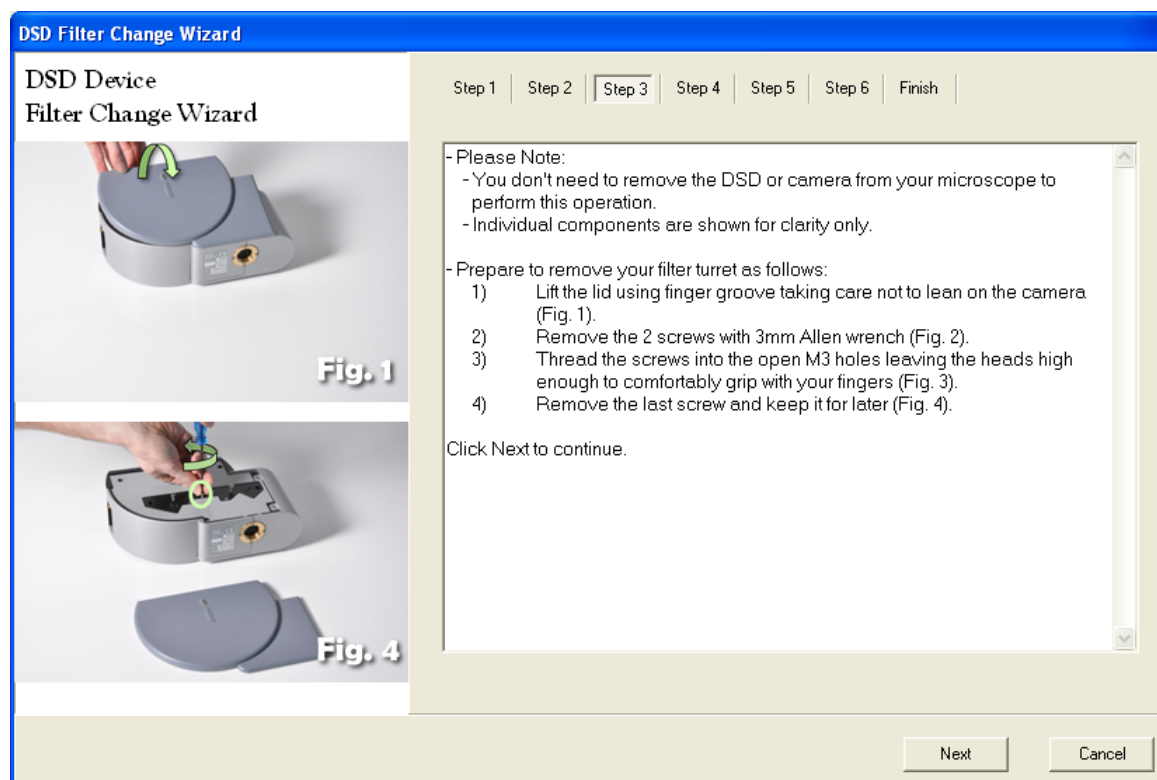

Once the system has been calibrated it is very easy to use. The Camera dialog houses a new tab called **DSD Processing** as shown here. This should be enabled and then the user can select the **Imaging Mode** as Confocal, Wide field or both and this will determine which images iQ captures during a Protocol. The Wide field mode can be very helpful in focusing the specimen in

the first instance.

A slider is provided to set the Confocal Black level. We recommend that the black level is set by imaging a region of the specimen where there is little no real signal or where the specimen is out of focus and ensure that the resulting confocal grey levels are in the range of a few tens.

The following figures show wide field and confocal images of the same field in a three-color tissue preparation. The high levels of detail, lack of flare and dark background is apparent in the confocal image.

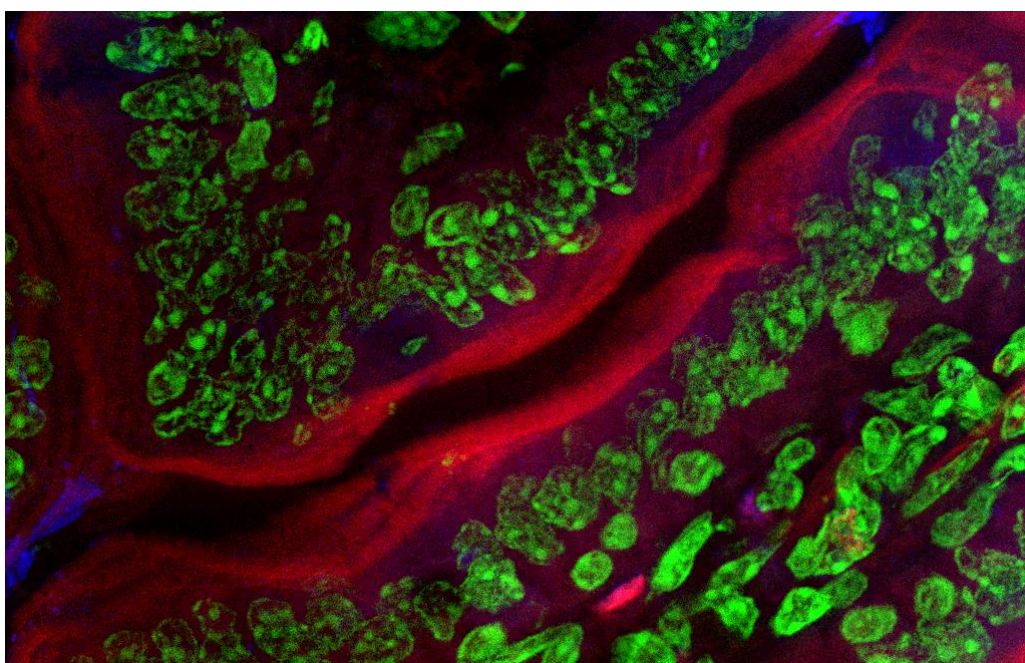
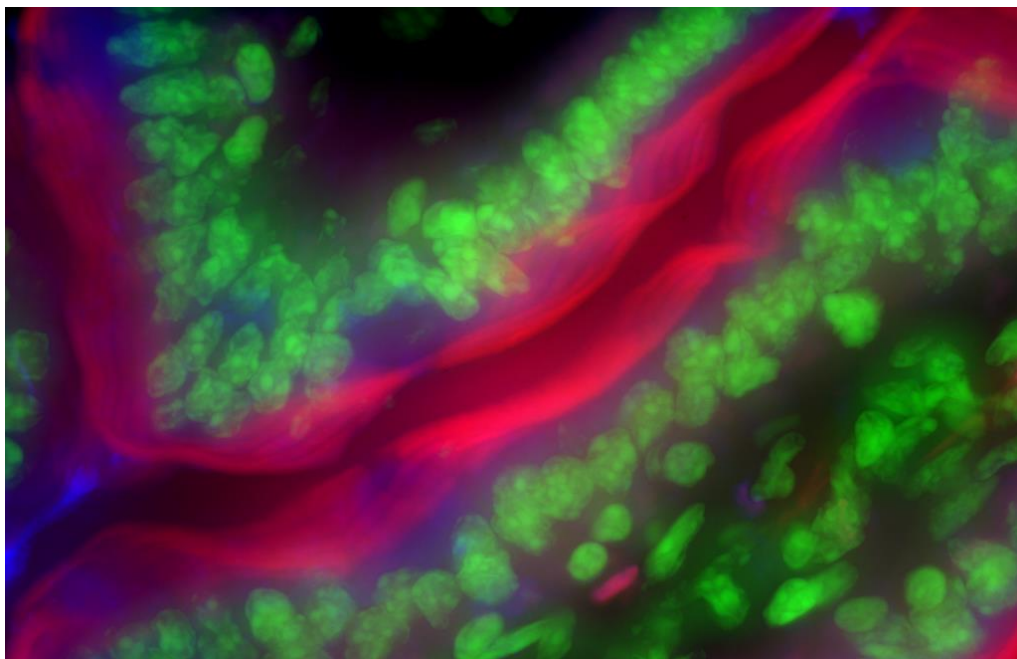

3.4 Dual Camera Image Alignment

Modern imaging systems can be readily configured for capture, processing and analysis of data from one or more cameras. In multi-camera systems the images may be combined for a variety of reasons. These can include comparison or combination of imaging modalities e.g. TIRF and confocal, DIC and fluorescence, or as a processing steps to characterize some property of the specimen e.g. FRET or ratio imaging.

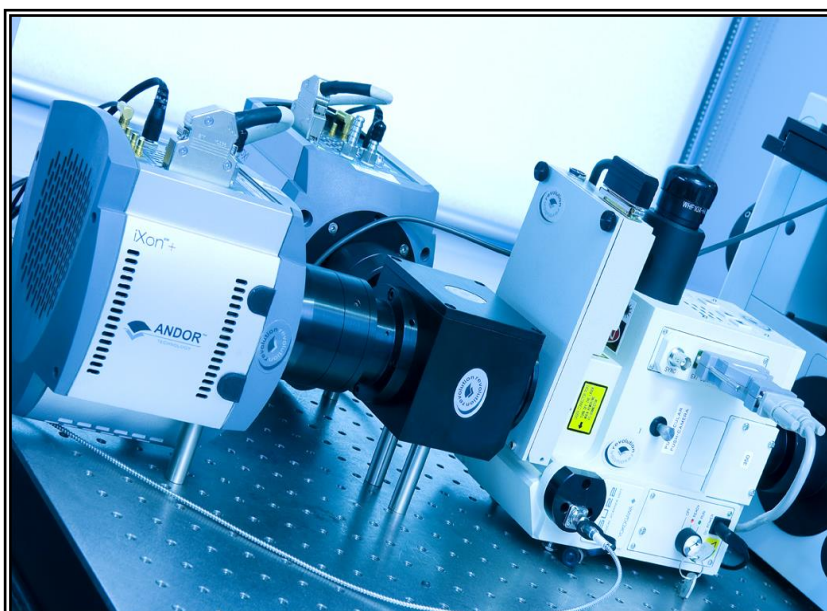

Andor has developed a flexible optical solution to split information between two cameras. The dual port camera adaptor (TuCam) shown allows dual wavelength or polarization imaging depending on which optical components are included in its modular optical cassette system.

The procedure that follows can be applied to images from other optical configurations, but will be described from the perspective of the Andor TuCam. For accurate data to be acquired from a dual camera system, it is important that the magnification, orientation and XY position of the cameras match each other as closely as possible. Assuming the optical paths are matched then we can use software to optimize the pixel-to pixel match. On the other hand if the images are of disparate linear resolution on the grounds of binning or pixel size, they can be overlaid for visualization, but would need to be re-sampled for pixel to pixel processing. Image re-sampling is not covered here.

In the following description, use of two identical cameras is assumed. The process described here is in 3 phases and refers to the **Master and Slave iQ systems, running either on two PCs or two instances of iQ running on a single PC**. The alignment procedures apply to both scenarios.

1. Align mechanically - First undertake basic mechanical alignment with a spirit level and make sure the two cameras are in focus.

2. Select most frequently used objective - Complete steps 3-6 for both cameras – this is the fine mechanical alignment phase. If using a microscope, select the objective you are using most for dual camera operations. This phase will adjust the cameras alignment to within a few pixels. Note that due to the beam splitter, the images from the two cameras, assuming the same physical orientation, will be flipped about the vertical axis.

3. Select 2 spots for alignment - Using transmitted or fluorescence light, make sure you have a suitable Live Image on each system from the cameras – use a specimen with punctate features e.g. pollen or multi-spectral beads. The exposure time does not have to be the same, but the intensities should be matched closely between the 2 images for reasons that will become clear later.

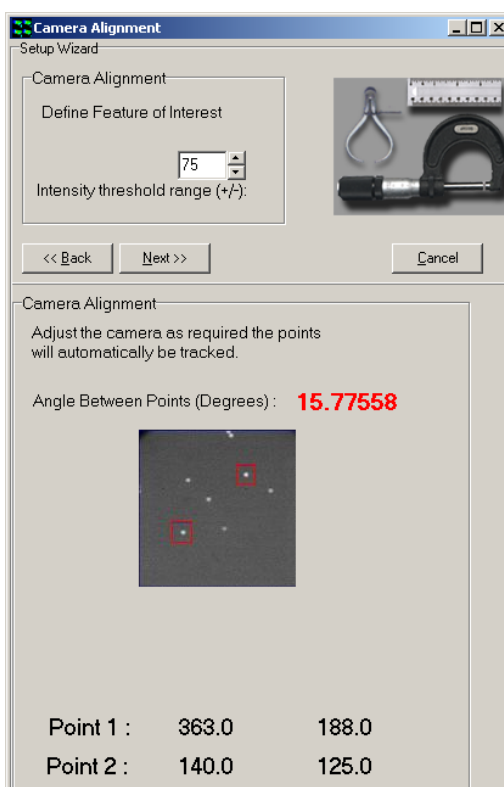

Adjust to match angle and XY - Using the **Align Camera Plug In**, which is accessed via the Wizards menu, select the 2 feature method to allow you to measure orientation and XY position of 2 user-selected spot. The camera physical rotation should not need further adjustment, but the cassette does allow for some adjustment of angle of the beam splitter angle. Use the TuCam cassette adjustments (see the description at the end of this document and figure below to optimize the XY positions of the spots until the Plug In reports angle, X, Y positions match as closely as possible. (Note that the dichroic mirror in the TuCam cube introduces a vertical flip of the image from that camera – so make sure to introduce

the correct flip/rotate in the Camera interface prior to matching alignment). If this is done correctly, you will be able to match angles between the two cameras, within a degree or so, when well aligned. Note also that angle or rotation is most critical here as small translation errors can be adjusted in the next phase using the alignment software. Once this step is done, reset the Flip/Rotate option on the camera GUI to None.

A maximum of two regions can be used for the alignment procedure. Select **2 Regions for registration** by clicking on the appropriate radio button.

4. Lock down and adjust cassette (applies to Andor DPC) - Once you have completed step 3, carefully and systematically lock the barrel set screws, checking that alignment is maintained. Minor adjustments to the cassette system may be needed once external supports are tight.

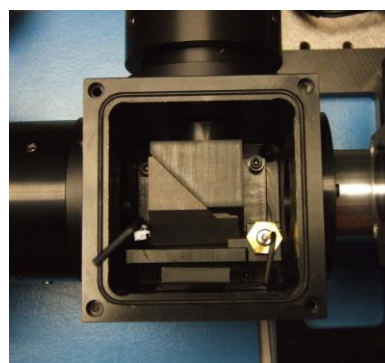

5. Use matched intensity images for software alignment - Snap images of closely matched intensity on each system for the software alignment step – if you have to adjust exposure time that is OK for setup. Use the **Dual Image Disk** Plug In on the Master system to connect to the Slave system and show the two Image Lists. See **chapter 2** for information on setting up a Dual ImageDisk configuration for use with two cameras and two PCs.

6. Make sure both lists have been Refreshed - select the two images at the top of the Image Lists. These two images will be merged into a dual channel image on the Master system, which will be used to create the software alignment file.

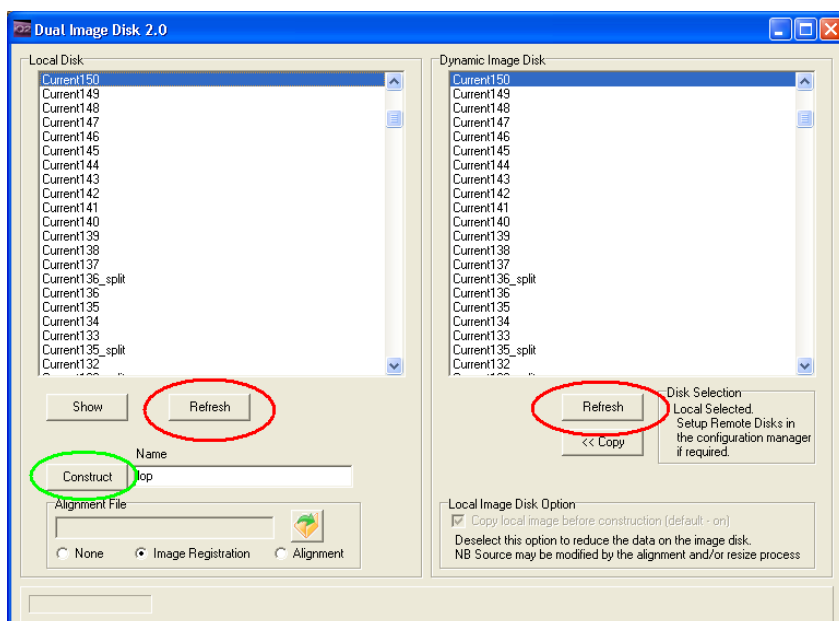

This dialog shows the **Dual Image Disk** dialog which is accessed from the **Process** Menu. The red ellipses highlight the Refresh buttons which update the lists. The **Constructor** button highlighted with green ellipse is used to create a dual channel

image based on matching the dimensionality of the image data selected on the right to that existing in the selected image on the left. This means that you can “construct” a dual-channel image from two single channel images.

7. Create a merged image - In the **Constructor** Edit box enter your chosen name for the merged image and click **Construct**. The Master system will copy the file from the Slave and create a merged image with your chosen name. Show this image by selecting it in the Master List and clicking the Show button. The example shown here exhibits the expected vertical flip and has been misaligned to emphasize the need for alignment.

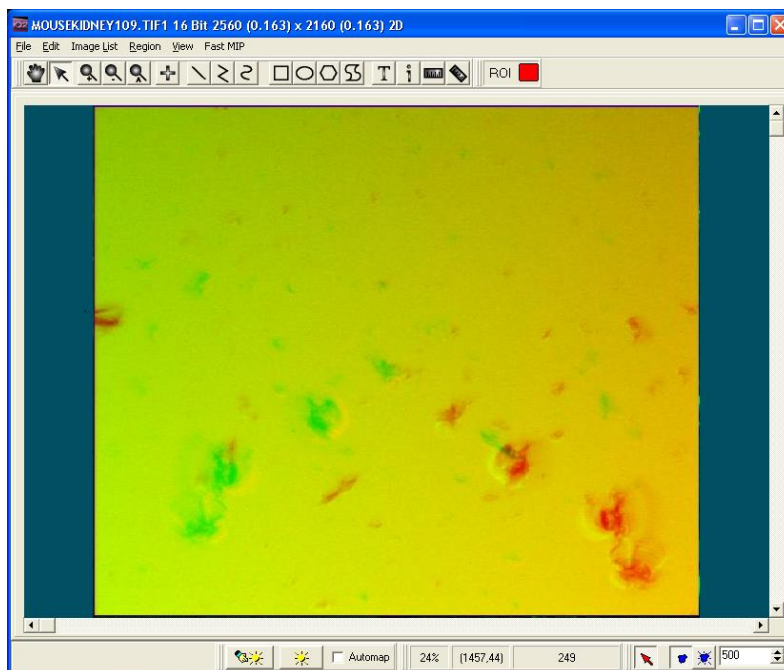

8. Use Field Split to adjust alignment and rotation of the 2 channels - Now select the Field Split Plug In from the Process Menu. The merged image will be displayed in the Plug In. If you select the Merge button you will see the channels overlaid and any shifts between the two will be apparent. In the main iQ Image Window, two rectangular regions will appear on the image and these can be moved around to adjust the relative shift between images. The 4-way arrow buttons are used to shift them in one pixel increments or the regions can be dragged on the Image Window if large steps are needed.

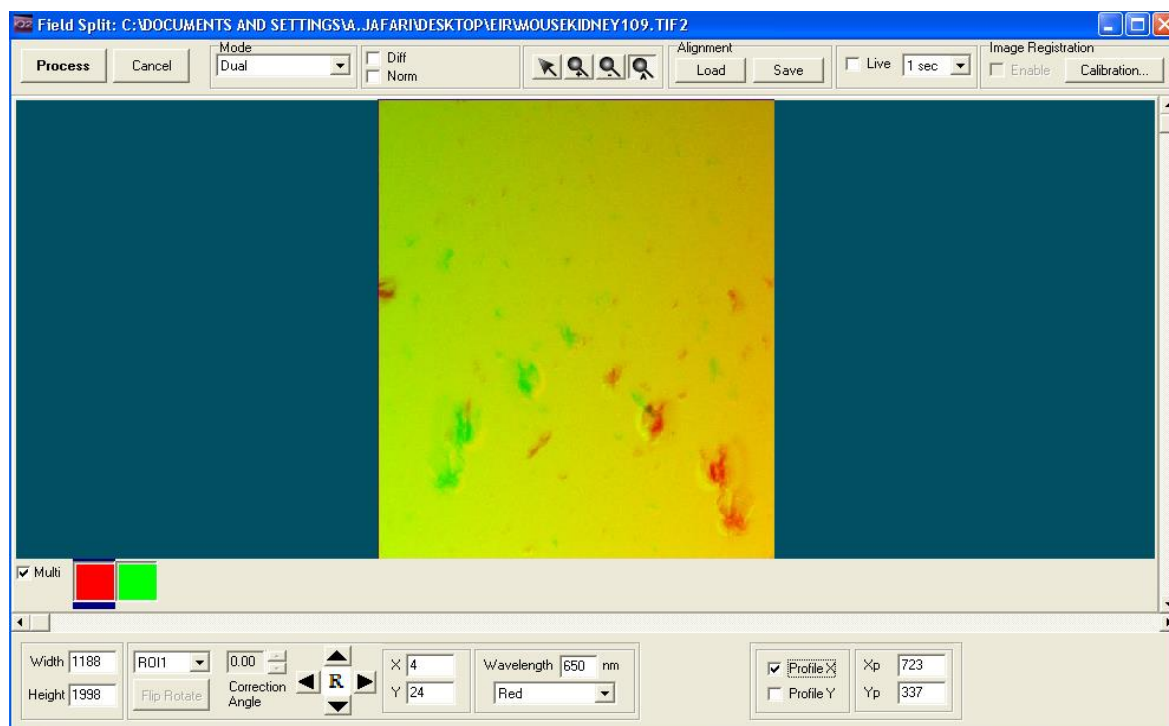

9. Check with Difference image - If you want to make sure the alignment is

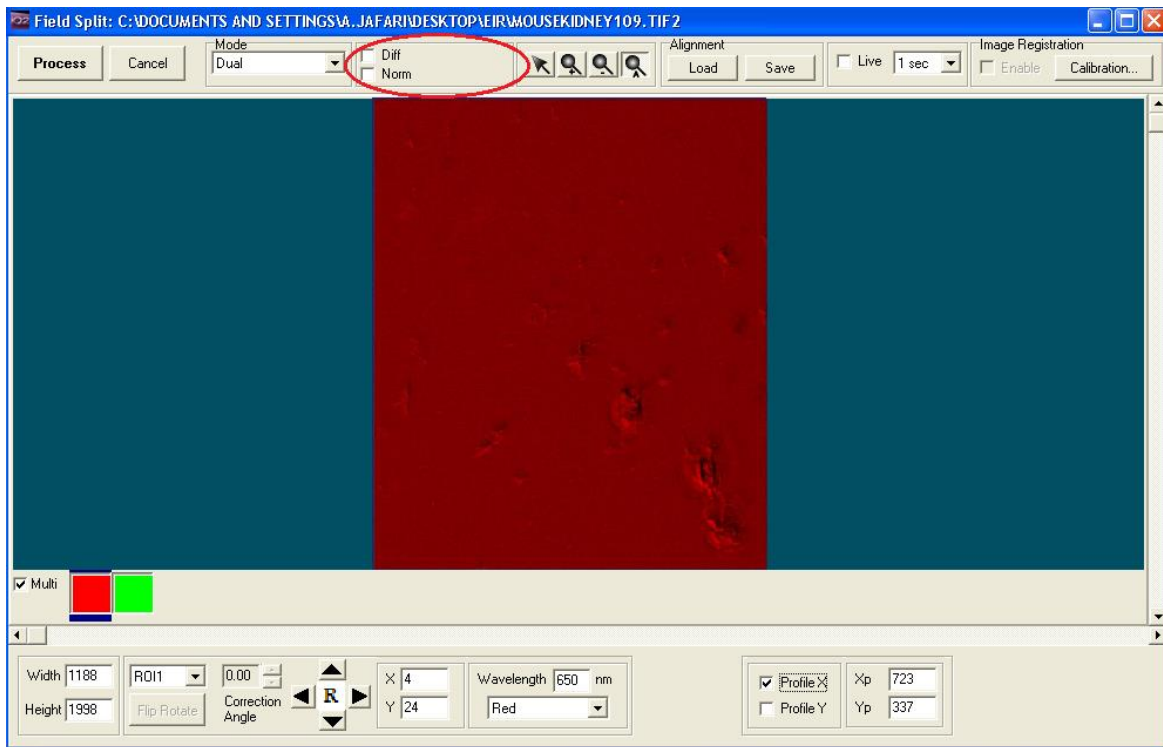

optimum, use the Diff check box at the top of the Plug In. This creates a difference image in the display and also computes the maximum difference in this image. You should try to minimize the Difference image to obtain the best match.

10. Save the alignment file - Once you have the best result you can achieve, use the Save button at the top of the dialogue to choose a name and Save the alignment file. You can use this file in the Dual Image Disk Plug In to perform alignment during the copy and merge steps to make the alignment process as close to automatic as possible for general use.

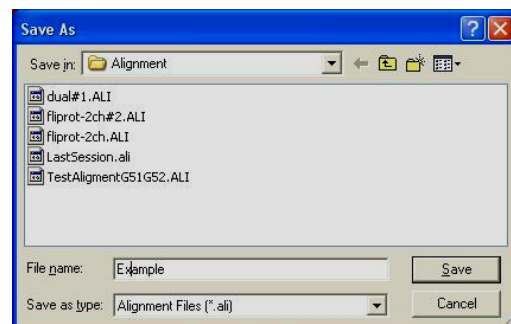

11. Use Field Split for Image Registration and rotation of the 2 channels – If you want to have more precise alignment, the Field Split plug-in provides users with an Image Registration algorithm to align images from two different channels more accurately. In order to use Image Registration you should load a high contrast

image and then follow all the steps described for adjusting the alignment. Once you have the best result you can achieve for the high contrast image, instead of saving the alignment file you should press the calibration button on the top-right of the Field Split Window. Follow the calibration wizard steps to create and save a calibration file which will be used for merging images from two channels in the Dual Image Disk. The calibration wizard for the Field Split plug-in is described in details in section A5.24.

12. Dual Image Disk Plug In - applies alignment automatically. Refer to Steps 5-6 above to explain the basic use of the Plug In.

13. Select alignment file for automatic use - To make sure that the images you merge from the Master and Slave systems are pixel-aligned as part of the copy and

merge steps, select the Alignment radio button as shown in the screenshot. To select the desired Alignment file, click the square folder button and use the file view to select the file named previously in step 10.

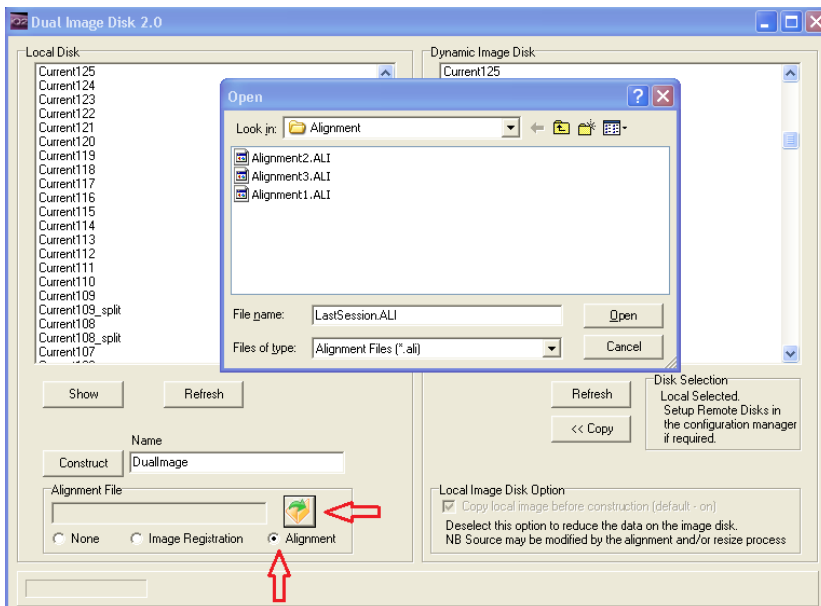

14. Select calibration file for automatic use – If you used Image Registration to create a calibration file in order to have more accurate alignment, you should use

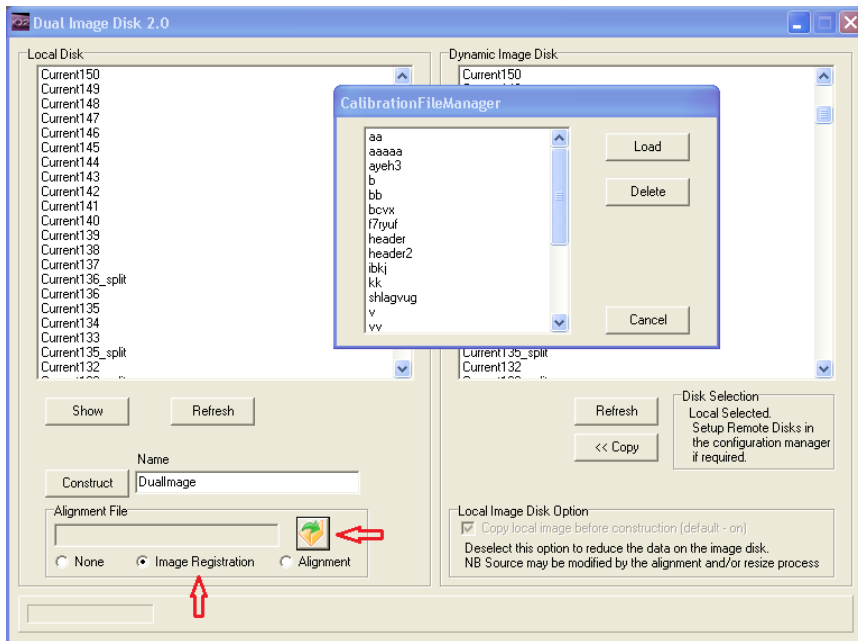

the calibration file created in step 11. Select the Image Registration radio button as shown in the screenshot. Click the square folder button and select the calibration file named previously in step 11.

15. Construct the aligned and merged files - Now when you select the Master and Slave images which you wish to merge, and click on the Constructor button, the copy will be done and the alignment/calibration specified by the file in section 13 or 14 will be applied automatically. If you select the **None** radio button in the Alignment File section no alignment will be applied to the merged image.

16. Remember to match the number of frames - in normal Master-Slave operation, Master drives a multi-dimensional acquisition and the Slave is triggered to acquire frame for frame. The user must make sure that the Slave is set to acquire the correct number of frames to match the total number in the Master image.

If you follow these steps all should work smoothly and you should gather well-aligned, high quality data for your studies.

3.5 Stage Alignment

Stage Alignment should follow System Calibration and once completed you will be ready to start acquiring images with your scanning stage.

NB If you never want to acquire images from a micro-plate (multi-well) or a montage (mosaic) then you can skip the stage alignment step.

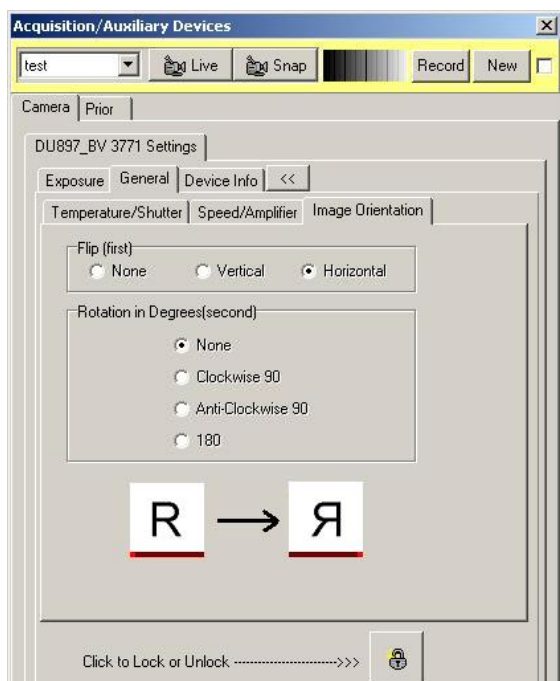

If you are using a camera which contains a back-illuminated chip e.g. iXon 897BV or 888BV, then you may have to flip the chip about the horizontal or vertical axis to correctly align the stage axes to the microscope. The chip is reversed in the housing to present the back of the CCD chip for illumination. Thus when the camera is readout one of the axes is reversed or flipped. **Make sure you do NOT enable FLZ for Stage Alignment.**

If you are using the side port on an inverted microscope, you may need to physically rotate the camera by 90 degrees. If that is not possible then you can use this software rotation step, but it does have a speed overhead so only use it if you cannot rotate the camera. This requirement results from the fact that the side port sees X motion of the stage in its Y plane and vice versa. These precautions will make the system feel more comfortable to use and avoid confusion or errors in scan patterns.

[Access to the camera orientation controls is via the Device Setup dialog on the camera tab.](#)

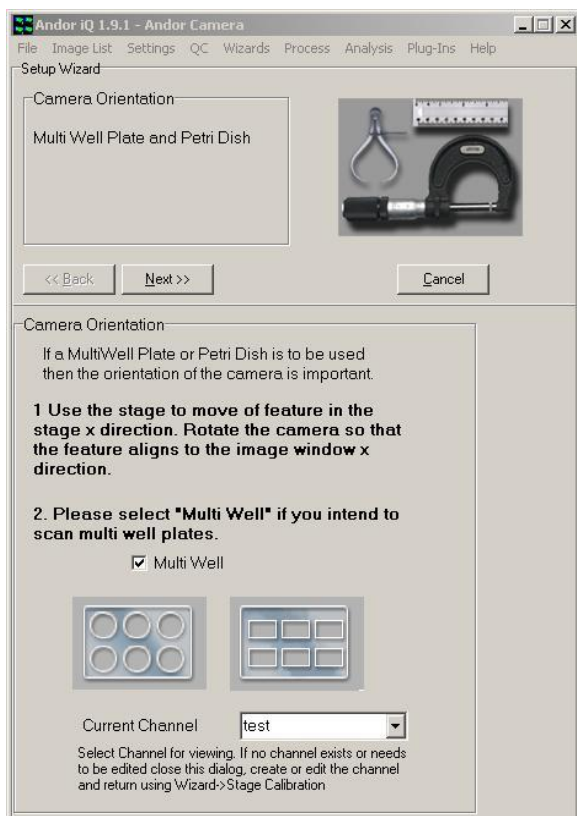

The Stage Alignment Wizard is accessed via the Wizards menu. In the first dialog, select the Multi-well option and follow instructions. Select a channel for the camera settings if you have one existing.

Place a micro plate onto the stage, move the first well into position above the objective lens and focus onto the bottom of the well. You can use a low power objective (e.g. 10X) to make this process as simple as possible.

Make sure there is some feature to focus upon, even a scratch or debris in the micro-plate base will do. Move the stage in the X direction and make sure that the

feature moves parallel to the horizontal axis of the Image Window.

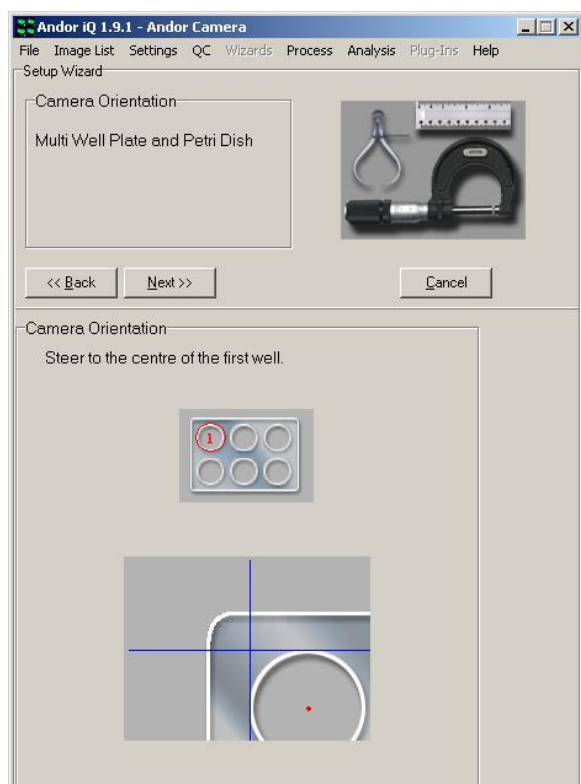

Press the Next button and then find the approximate center of the first well as shown.

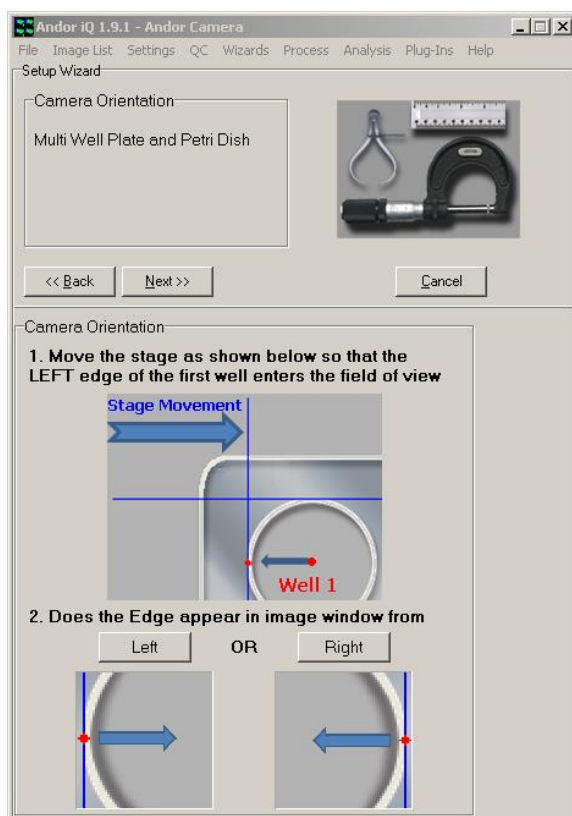

Now move the left hand edge of the first well into the field of view of the objective. The left hand edge of the well is the nearest edge to the border of the plate. Select the Left or Right button in the wizard depending on which resembles most strongly the Live image in the Image Window as the stage plate makes its way to your right.

At this point, you click on the **Right** button if you see the left edge of the first well move into the field of view from the right and **Left** accordingly. If you choose Right you may see the message below and you

may have to rotate the camera physically by 180 degrees to ensure correct scan operations. If you can not rotate the camera you can modify the camera orientation in the device setup dialog if your camera supports this feature (see the beginning of this chapter for more details).



Then click on OK and IQ will return to the stage above, where you will need to rediscover the left edge of the first well.

Now relocate the approximate center of the first well again and move the top edge of the first well of the micro plate under the objective. The top edge of the well is the nearest edge to the border of the plate. Select the Top or Bottom button in the wizard depending on which resembles the Live image in the Image Window.

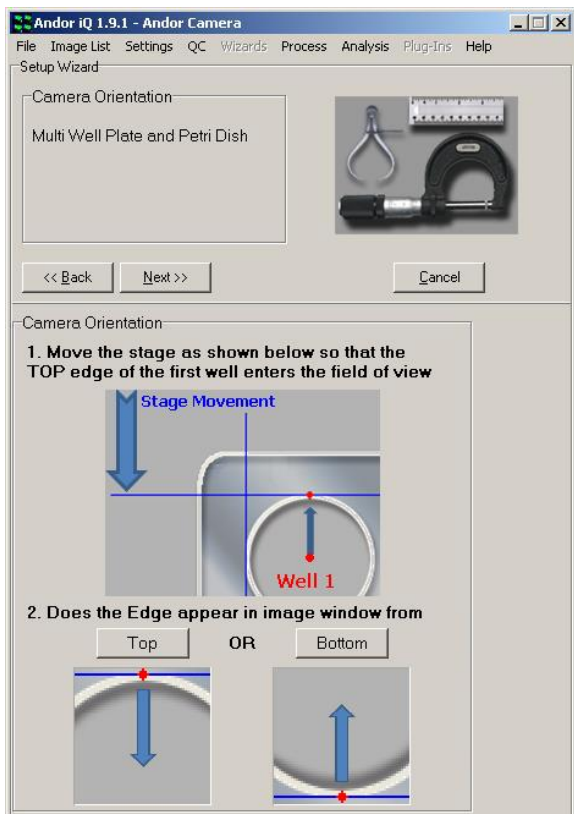

Click on the Next button.

Now follow the steps to ensure that the camera axes are closely parallel to the stage axes. This is necessary to ensure

that mosaics and micro plates are accurately scanned.

This dialog asks you to make sure you have a feature in your field of view of a small size (< 50 pixel diameter) and of high contrast – this is often easier in transmitted light, but fluorescent beads are also fine - even the debris on a cover slip or the previously used micro plate will act as a suitable target. See below for an example specimen image.

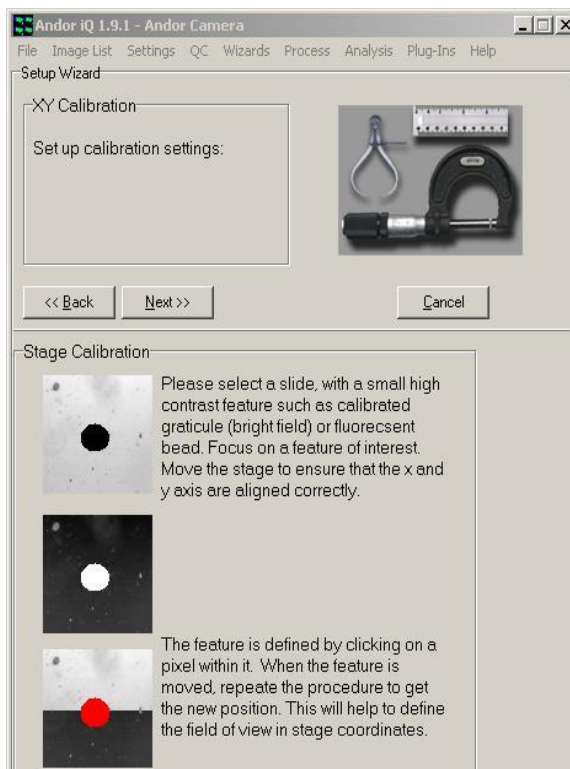

Make sure the correct calibration is chosen to match the objective being imaged. This allows the system to make the correct sized moves when it is computing the camera angle relative to the stage.



As this process proceeds you will be asked to rotate the camera or the stage. On an inverted microscope the latter is not possible, so the camera may need to be adjusted. So be prepared!

Click on the Next button.

In this step of the stage alignment, iQ will put a grid on the image Window (see below) and ask you to steer a high contrast feature into the top left region and then to the bottom right region.

By identifying the feature and reading the stage motion, iQ can make an automatic calculation of the relative angle between the

stage and the camera.

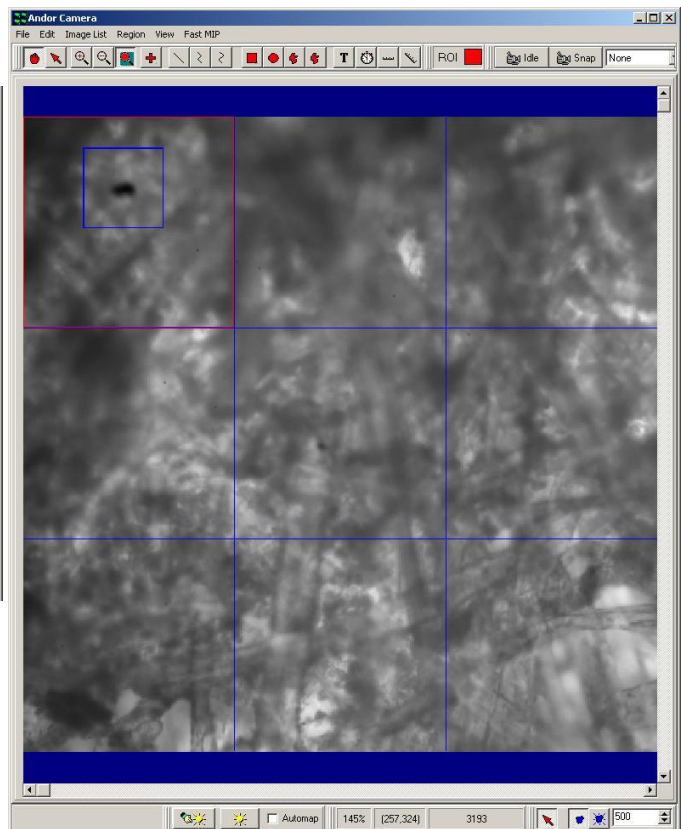
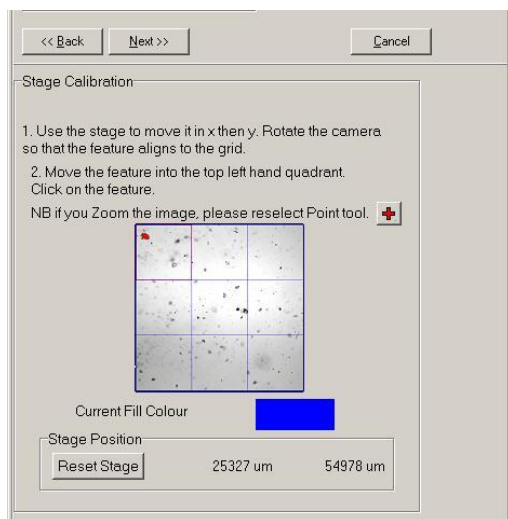

Andor iQ USER GUIDE

The screen shot above shows the first stage of the angle measurement sequence. A high contrast feature has been placed in the top left grid region using the stage joystick, identified by a user mouse click and Point tool “+” selected.

Next the feature will be navigated down to the bottom right grid region using the stage joystick. A mouse click on the feature will allow iQ to capture its new position. The screen shots are shown below.

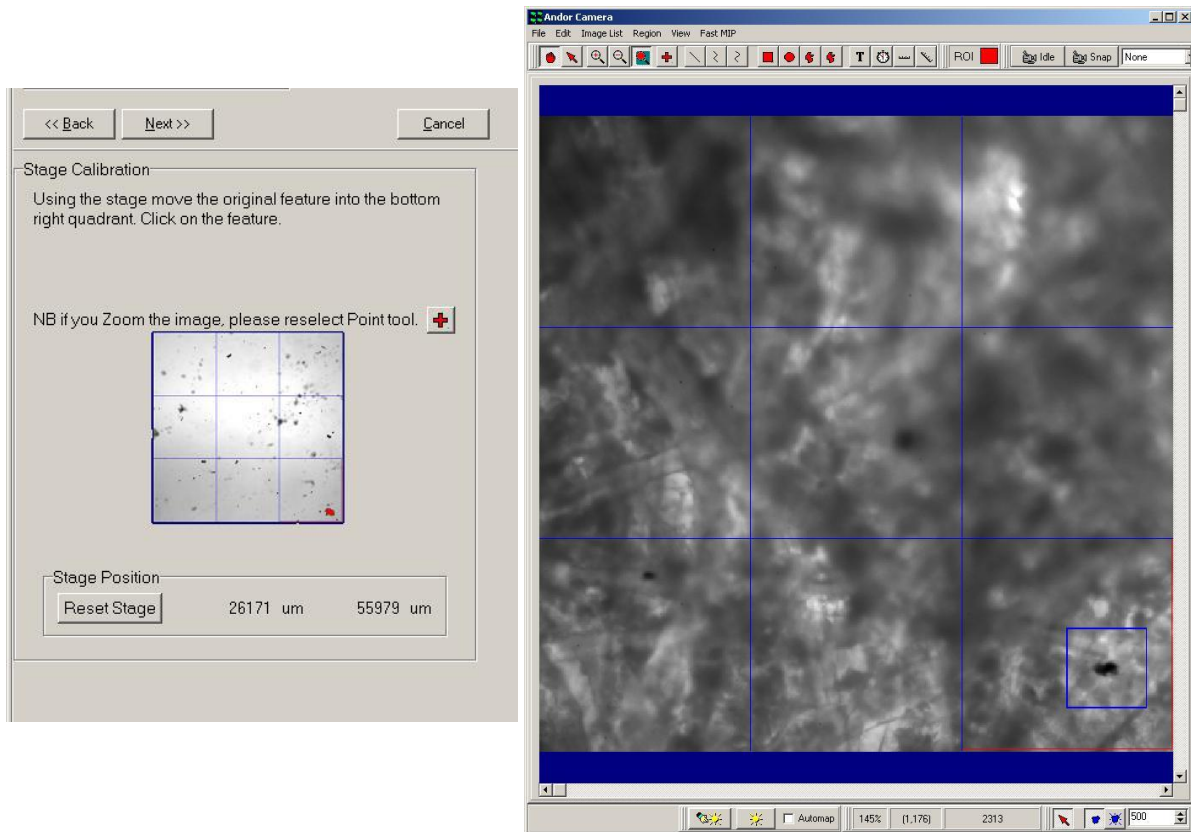

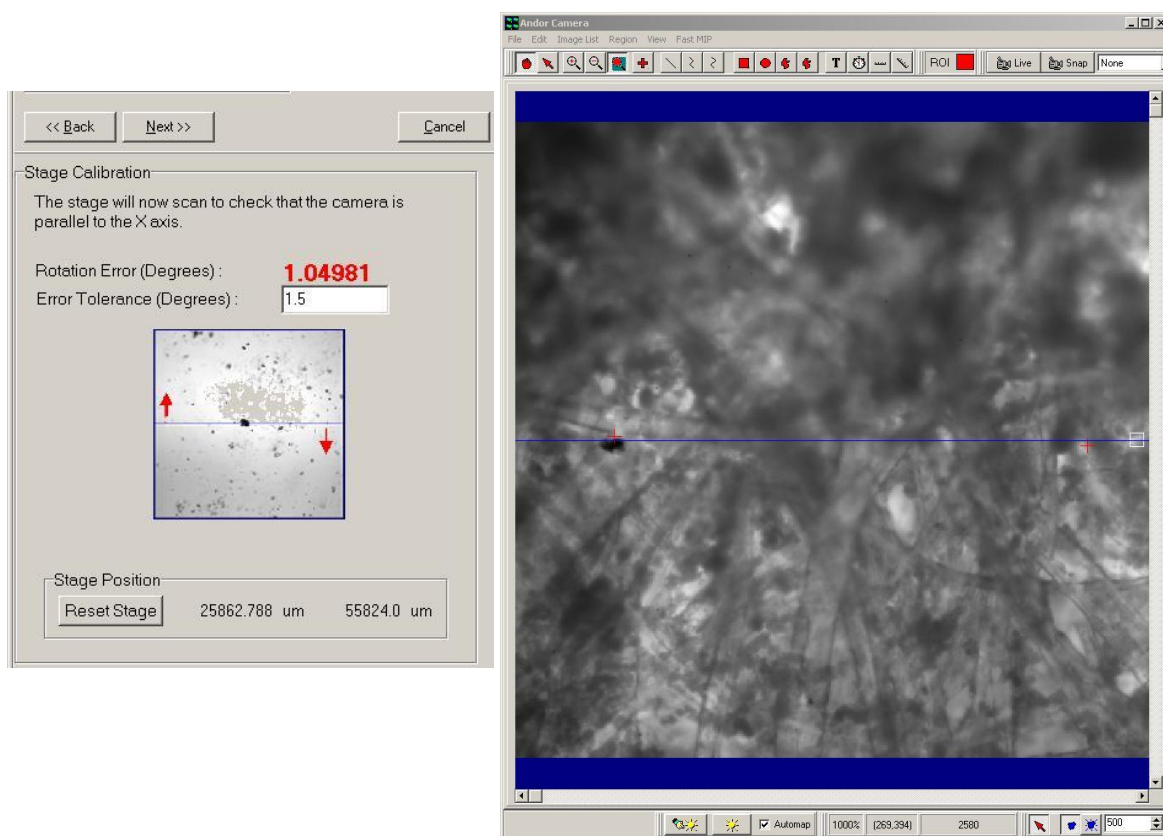

In this final step of the Stage Alignment Wizard, you will see in the Image Window that iQ moves the stage from the left to the right, snaps a frame and then computes the feature's position. Each move and compute generates two coordinates which correspond to a move in the X axis of the stage. From these coordinates the relative angle can be computed. iQ displays the computed angle in Bold red characters. Below this you can edit the acceptable error for your purposes. The default is set to 0.5 degrees, which is our recommendation for good performance.

The quality of Montage or mosaics may be especially susceptible to large errors (>1 degree) in the angle.

In order to change the rotation error angle, simply rotate the camera and wait for the next computed angle to be computed and displayed. Go on with this process until the rotation error drops below the error tolerance.

Click on the Next button.

Note: After you click Next iQ moves the stage around, automatically identifies and measures the feature movements in order to calculate stage X and Y resolution as a sanity check for the stage calibration. This may take some time e.g. 10 seconds. The cursor may flash during this process. This is normal behavior.

This last panel contains a summary of your new settings (left) It provides a good “sanity” check regarding your motorized stage calibration. You can indeed compare the result calibration with the resolution set in the Device Setup dialog in the stage panel and update the latter, but please make sure that you check with the stage user guide or our support team to confirm the correct setting. Note that an error in

the Calibration Wizard (section 3.2) such as incorrect specification of the C-mount magnification can give rise to scanning errors when pixel to stage movement is incorrect.

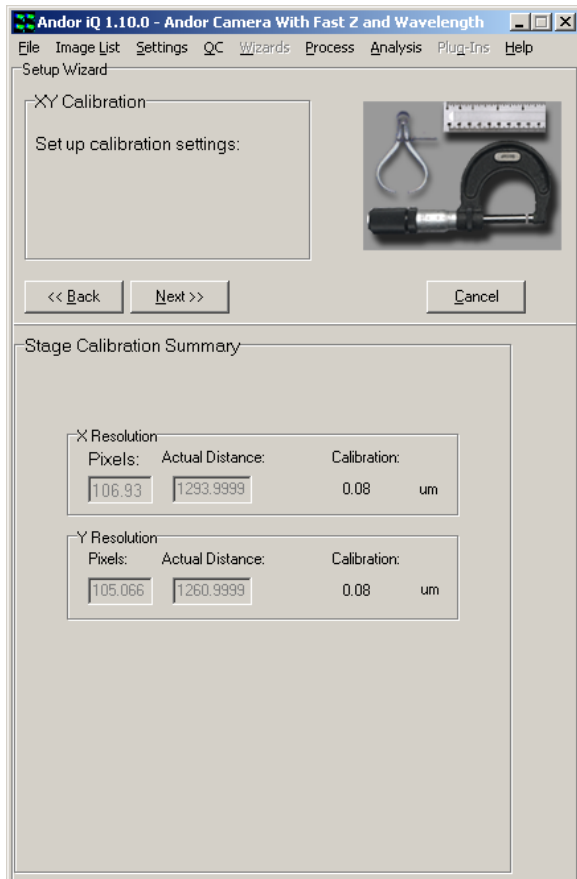

3.6 FRAPPA Devices and Calibration

“FRAPPA” – was the name we gave to our first innovative photo-stimulation product which is described in more detail below. FRAPPA is an acronym for Fluorescence Recovery After Photo-bleaching and Photo-Activation. In April 2010 Andor acquired Photonic Instruments and with it the patents and designs for two other innovative photo-stimulation products, namely Mosaic and MicroPoint.

3.6.1 Mosaic - solid state digital illumination

Mosaic is a digital illumination system which utilizes digital mirror device (DMD) technology to control the illumination field of a fluorescence microscope. Using laser or arc lamp sources, Mosaic achieves real time and near-diffraction limited resolution. Mosaic can simultaneously and precisely excite multiple regions of interest with complex geometries (parallel multi-region illumination) and allow simultaneous imaging. Mosaic is unique, yet flexible, operating over wavelengths ranging from 365 to 800 nm with applications including uncaging, photo-conversion, activation and bleaching.

Mosaic is in use with laser scanning and spinning disk confocal systems as well as wide field or epi-fluorescence microscopes. iQ software drives Mosaic to map a mask defined in image view directly into the specimen plane at a rate exceeding 60 fps. Its simple optical design is readily integrated with complex optical microscope systems designs to realize diffraction limited imaging with minimal loss over a broad spectral range. Unlike traditional galvo-scanning systems where pixels are addressed sequentially, Mosaic provides truly parallel illumination of multiple complex ROIs. MOSAIC exploits solid state digital mirror technology (DMD) to create a digital illumination systems ideal for parallel multi-region FRAP and PA.

3.6.2 MicroPoint - tunable, galvo-steered, pulsed laser delivery

MicroPoint is a pulsed laser delivery system with bio and industrial imaging applications. It is available in manual and galvo-steered versions and delivers 337 nm pulses from a Nitrogen pulsed laser (~3ns, 70 μ J) via optical fiber to a dye cell resonator. Dye cells are available to convert the UV pulses to more than 20 user-selectable wavelengths ranging from 365 to 580 nm. Custom-designed achromatic microscope adapters ensure that near diffraction-limited pulses are delivered to the specimen. MicroPoint is an excellent photo-stimulation tool providing ablation, uncaging, activation and bleaching capabilities, adapted by tuning wavelength and energy. Simultaneous and precise illumination and ablation of multiple regions of interest minimizes collateral sample damage. Angular and spatial alignment of the illumination at the sample target is manually controlled via a 2-axis joy stick. Focus in the z-direction is manually controlled with a knurled focus ring.

3.6.3 The FRAPPA Device

Andor's FRAPPA uses a patented dual galvanometer scan head to provide a computer-steered laser beam delivery system with no scan or "f-theta" lens. It can be configured in line with a CSU and/or camera and operates in two modes and has the following key functions.

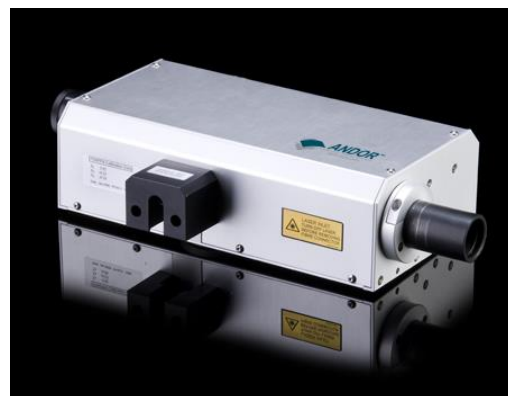

- Pass-through mode – FRAPPA acts as an optical relay system with 1:1 imaging – orange path in the image below.
- FRAP mode – galvanometers are aligned to steer and image laser light from a single mode optical fiber onto the specimen in a point scanning mode - Red path shown in figure above.

Mode switching occurs in < 5 ms.

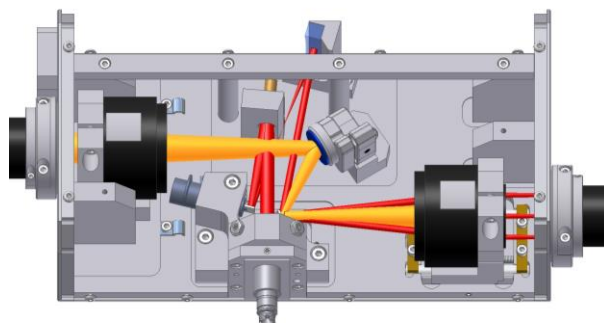

Integrated control with iQ software provides "point-and-shoot" and sequenced protocol modes. Both allow arbitrary, multi-region scanning of points, lines and polygons. The dwell time of the laser, or the length of time the laser is exposed on each point, can be controlled from Device Setup. Also, the same region can be bleached a specified number of times thus allowing accumulated exposure. This allows control over exposure control at the point level as well as the region level.

Under Andor iQ control, the user commands FRAPPA to bleach or activate regions of interest with user-defined times, laser lines and powers. Laser switching is tightly synchronized with FRAPPA modes of operation, using our proprietary laser

combiner multi-port switch (MPS).

There is a limit in FRAPPA region definition for a single FRAPPA action. This is based on the number of scan lines (rows) in the set of FRAPPA regions. Each time a new region or group of regions is FRAPPA'd these are uploaded to the scan head electronics which has a finite memory size. Essentially the scan pattern is stored as a run length sequence in which each region is stored on a row basis with On and Off X coordinates like this (on and Off are shown for clarity only):

Row	X coordinates for On and Off					
76	On: 4	Off: 20	On: 103	Off: 214		
77	On: 4	Off: 21	On: 102	Off: 216	On: 243	Off: 307
78	On: 4	Off: 22	On: 101	Off: 218		
...						
213	On: 89	Off: 303				
214	On: 89	Off: 303	On: 370	Off: 432		

The scan processor gates the laser blanking output On and Off in each scan line as required. When the scan processor executes the final Off action in a line it resets to the next On position in the list. If it encounters the end of the list it either goes back to repeat the list or returns control to iQ.

The maximum number of On-Off actions is approximately $1250-(n*3)$ where n is the number of regions. The internal storage format is a little quirky so you may see some small variation around this number. And of course it becomes more of an issue with small pixel cameras like Neo/Zyla.

3.6.4 What Information Can FRAPPA Reveal?

Imaging the effects of FRAP or PA in living cell specimen can reveal qualitative and quantitative information about intra-cellular molecules, structures and their environment. UV uncaging is used to deliver agonists to specific cellular compartments, while photo-activation is applied in studies ranging from repair of photo-induced DNA lesions, to manipulation of light sensitive channels (channelrhodopsins - <http://edboyden.org/07.03.han.html>) and the study of molecular assembly and disassembly of cellular structures (e.g. actin and tubulin filaments). The techniques can even be applied at the cellular level to drug candidates for photodynamic therapy.

An example of a photo-bleach recovery sequence intensity profile is shown to the right. A represents the pre-fluorescence intensity, B the bleach depth, C the recovery phase where time constant information is revealed and D the recovered level.

FRAPPA techniques allow measurement of molecular recruitment rates, trafficking and turnover in single cells and sub-cellular organelles and applications include membrane and protein binding, mitosis and cytoskeleton function. In these studies GFP is commonly used in a fusion protein complex to label a protein of interest. The bleach or activation phase “marks” those

molecules for observation. Quantification of motion or recovery can provide a useful measure of molecular mobility. FRAP is used increasingly in analytical devices to determine the identity of unknown substances (based on diffusion analysis), understanding cellular transduction and identifying ligand binding sites.

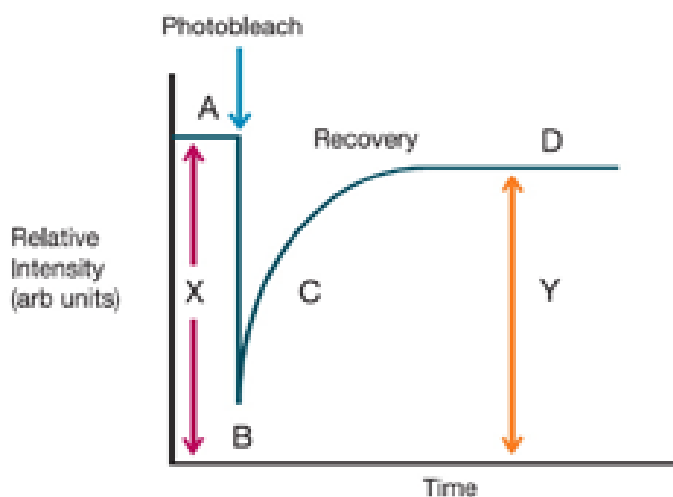

3.6.5 FRAPPA Calibration Wizard

The following sequence provides step-by-step instructions on how to calibrate the different FRAPPA devices that may be included in an Andor system. Note that it is possible to use more than one device in a system. Refer to Section 3.6.6 for multiple FRAPPA device calibration.

3.6.5.1 FRAPPA device

Before you start running the software, make sure the FRAPPA is correctly installed and aligned. Here are some tips on the installation procedure, but if the unit is already installed then skip to step 3 below.

1. Couple the FRAPPA unit to the microscope C-mount and (if present) the CSU. Using a spirit level, ensure that sure the FRAPPA, camera and other components are level and are adjusted to the correct height. The system should be mounted on an optical table or breadboard for best results and once the components are aligned vertically make sure to fix adjustable feet etc. **Note: Incorrect vertical alignment will lead to significant errors and may frustrate alignment of the FRAPPA unit.**

2. Horizontal alignment must now be adjusted. This can be done with transmitted light imaging if desired. Focus a specimen and adjust for Kohler illumination. Sliding the components left to right may be sufficient for alignment and should be done so that no vignetting/occlusion of the camera field is observed. Once this is achieved then clamp components onto the optical table so they are now locked down. Using the CSU imaging Channel focus the specimen in confocal mode and make sure that no vignetting is seen. If there is an issue here repeat step 2 until this is resolved.

3. Preliminary setup requirements: a) we assume that you have an iQ **Configuration** that includes all the devices you wish to use (including the ALC with MPU), selected camera and CSU). b) Make sure that you have a suitable sample for photo bleaching – either **Andor Test Slide #001** or a fixed Molecular Probes© specimen e.g. Cells#2 where microtubules are labeled green – excited at 488 nm. c)

Start Andor **iQ 1.8.1 or later** (exe dated Nov 15 07 or later). d) Make sure that FRAPPA is connected on a suitable COM port and let FRAPPA complete its self-calibration – the scanner goes through a self-test a start-up and when completed will show green lights on the controller front panel. This takes about 30 seconds.

Note the FRAPPA calibration is independent of objective magnification, but depends critically on the camera orientation, alignment and pixel organization.

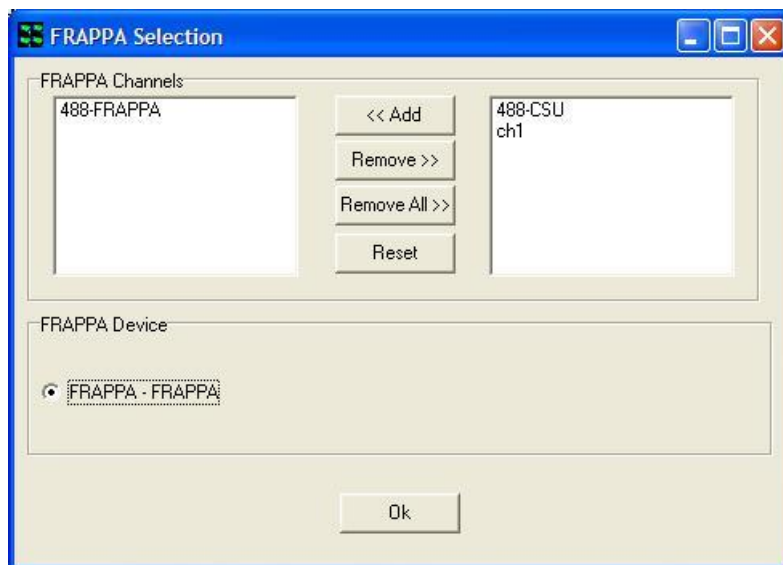

e) Create **CSU Imaging Channel** and a **FRAPPA Bleaching Channel** and then assign the FRAPPA Channel in iQ in the **Select FRAPPA Device** as shown in the figure above. It is sensible to reduce the laser power to about 10% in FRAPPA channels, as all of this power will be concentrated into a single laser spot during FRAPPA actions.

4. Run the FRAPPA Calibration Wizard from the Wizards menu. If there are multiple FRAPPA devices in the configuration, select the FRAPPA – FRAPPA radio button to calibrate the FRAPPA device. Choose to create a **New** FRAPPA calibration or choose the FRAPPA calibration you want to **Edit**.

5. Next, you must centre one of the **FRAPPA galvos for imaging** as shown in the figure below. Select the CSU imaging channel and make sure that you can see a clean confocal image. **Note this step is not required for Mosaic and MicroPoint.**

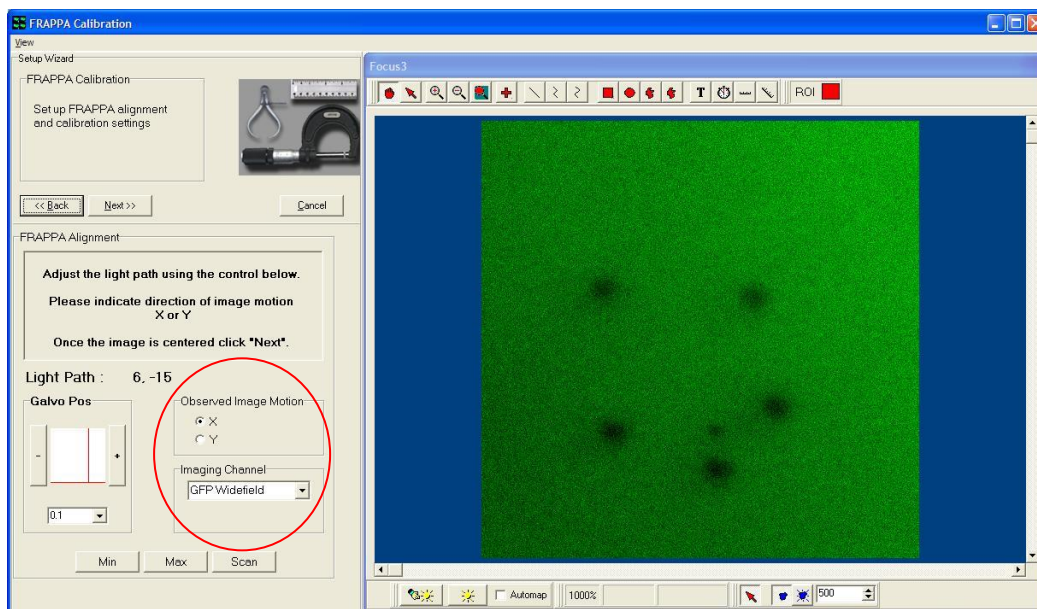

Using the single axis control as shown above, set the **Imaging Angle** to the value shown on the Calibration label – this label should be attached to the unit. **Note** that if you are Editing a FRAPPA calibration then the Wizard should reset this value automatically. Then change the angle in steps of 0.1 degree and then indicate on the **radio buttons** whether the image moves in X or Y. This allows iQ to establish which axis is under control for the following steps. Return FRAPPA to the **Imaging Angle** to the calibration value before proceeding. Then click Next.

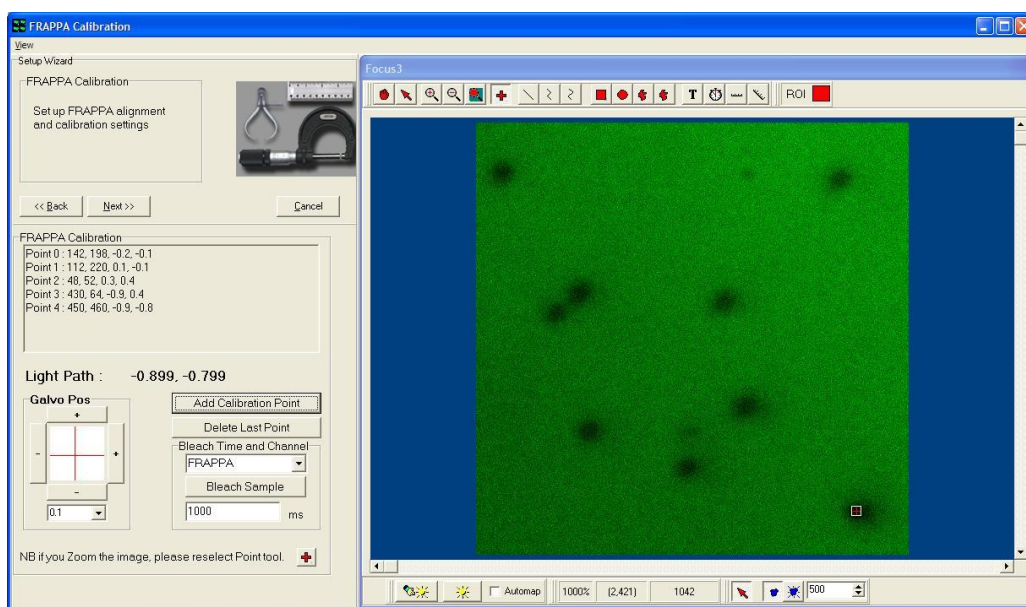

6. The FRAPPA Calibration panel allows you to calibrate how the FRAPPA angles translate to camera pixels. This ensures that interactive FRAPPA operations can be executed at the correct position. Start by setting the X and Y values to the **Scan Centre** values recorded in the calibration label. **Note** that if you are Editing a FRAPPA calibration then the Wizard should reset the center values automatically.

Now with the specimen in focus, select a suitable FRAPPA channel and click the FRAPPA button. If the system has been pre-aligned, you should see in the image a region of the specimen which has been bleached. A bleached region will appear darker than the rest of the specimen and should be localized. **Note:** if the bleach cannot be seen you may need to scroll the XY stage a little, or increase the FRAPPA time if the bleach is still not visible. This step of finding the initial bleach may be tricky the first time you calibrate the system.

Once the bleach spot has been identified (in the field of view), then you must create corresponding pixel coordinates and angles for the calibration procedure. To do this, for each bleach point (region), click on your best estimate of the region center (with the + marker) and then click on the button labeled “**Add Calibration Point**”.

Select 0.1 degree steps and incrementally adjust the two axis controls. Using 0.1 degree steps, establish which directions correspond to the camera X and Y directions. Each time you increment the angle by one or more 0.1 degree steps, then FRAPPA, locate the bleached region center with the “+” and click on **Add Calibration Point**. Create at least 4 and preferably 7-8 points for calibration. Use the angle adjustments to **create bleach points at the corners of the image** as well as around the center.

When you are satisfied that you have sufficient points over the image, then click on Next and the FRAPPA Calibration will be created by the system and used henceforth whenever a FRAPPA action is requested/demanded.

7. Setting the FRAPPA focus control

Now that the FRAPPA system is calibrated in X and Y you can use it in “**FRAPPA on Demand**” mode. This means you can go live and use a FRAPPA region type with a FRAPPA on Mouse Up action.

Place a “+” FRAPPA region on the focused specimen image and right mouse on the region. Select the “FRAPPA on Mouse Up” option – when selected it will be checked. Assuming the calibration above is accurate, when you mouse up after moving the region the area immediately below the region in the specimen will be bleached. It is possible that the spot size will be larger than desired – this depends on the exact optical configuration, but in general it should be possible to bleach a spot of <1.0 micron.

If the spot size is much greater than 1 micron, or appears to be in another optical plane (Z position) then you can (carefully) adjust the fiber input focus position. To do this, remove the laser safety shroud (see above) and you will find a thumb screw which when rotated moves the fiber position in and out. Adjust the position in small increments, while using the Mouse Up action to bleach. Once the spot size has been reduced to 1 um or so then you should consider this a good setting. If the beam cannot be reduce to about 1um, then you may need to reduce laser power or bleach time.

Note: Make sure to replace the laser safety shroud if you remove it to make any adjustments to the fiber focus position.

Finally perform a series of FRAPPA tests within iQ making sure to test points and ROIs.

3.6.6 MicroPoint Calibration

MicroPoint must be installed and aligned by a fully trained Engineer.

1. Preliminary setup requirements:

A) we assume that you have an iQ **Configuration** that includes all the devices you

wish to use (including the ALC with MPU), selected camera and CSU).

B) Make sure that you have a suitable sample for photo bleaching – either **Andor Test Slide #001** or a fixed Molecular Probes© specimen e.g. Cells#2 where microtubules are labeled green – excited at 488 nm.

C) If the MicroPoint is being used for ablation, use the first surface mirror (provided with the device) to properly calibrate the system. The MicroPoint ablates a series of holes in the mirror that are illuminated in transmitted light and used for calibration.

D) Start **Andor iQ 2.0 or later** (exe dated July 28 10 or later). d) Make sure that MicroPoint is connected on a suitable COM Port.

Note: the FRAPPA calibration is independent of objective magnification, but depends critically on the camera orientation, alignment and pixel organization.

You may wish to create a Frap channel for MicroPoint as with the FRAPPA, but this is not essential, as the MicroPoint device is not in the light path, and you may use the **current** channel settings to Calibrate.

2. Run the FRAPPA Calibration Wizard from the Wizards menu. If there are multiple FRAPPA devices in the configuration, select the MicroPoint – FRAPPA radio button to calibrate the MicroPoint device. Choose to create a **New** FRAPPA calibration or choose the FRAPPA calibration you want to **Edit**.

3. Next, you may select the Manual checkbox if you wish to manually select a range of positions / points to calibrate, but **we recommend** you keep the Manual **checkbox de-selected** as this will automatically provide a list of positions / points which will deliver the best calibration for the device range.

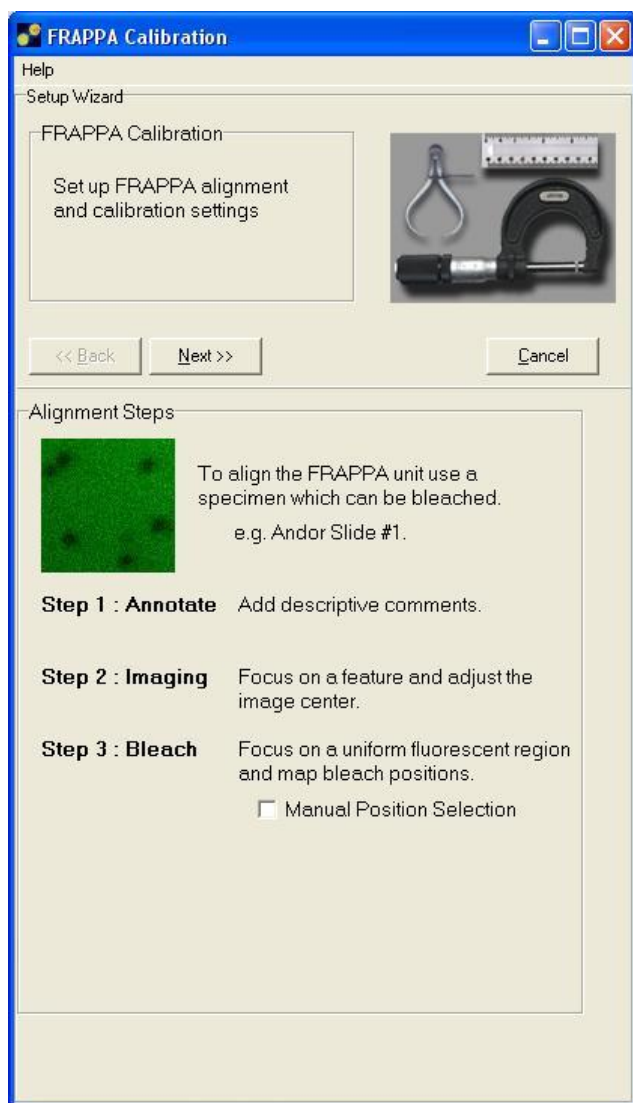

4. The Calibration panel allows you to calibrate how the device range translates to camera pixels. This ensures that interactive FRAPPA operations can be executed at the correct position. Below the combo box of pre-defined device positions, if “Auto-Increment” is checked, the device will automatically move to the next position when the “Add Calibration Point” button is clicked for the current position. If “Bleach on Selection” is also checked, the new position will be bleached, allowing the calibration to flow more easily. Now with the specimen in focus, select a suitable Frap channel and click the Bleach Sample button. If the system has been pre-aligned, you should see in the image a region of the specimen which has been

bleached. A bleached region will appear darker than the rest of the specimen and should be localized.

Note: if the bleach cannot be seen you may need to scroll the XY stage a little, or increase the FRAPPA time if the bleach is still not visible. This step of finding the initial bleach may be tricky the first time you calibrate the system.

Once the bleach spot has been identified (in the field of view), then you must create corresponding pixel coordinates and angles for the calibration procedure. To do this, for each bleach point (region), click on your best estimate of the region center (with the + marker) and then click on the button labeled “**Add Calibration Point**”.

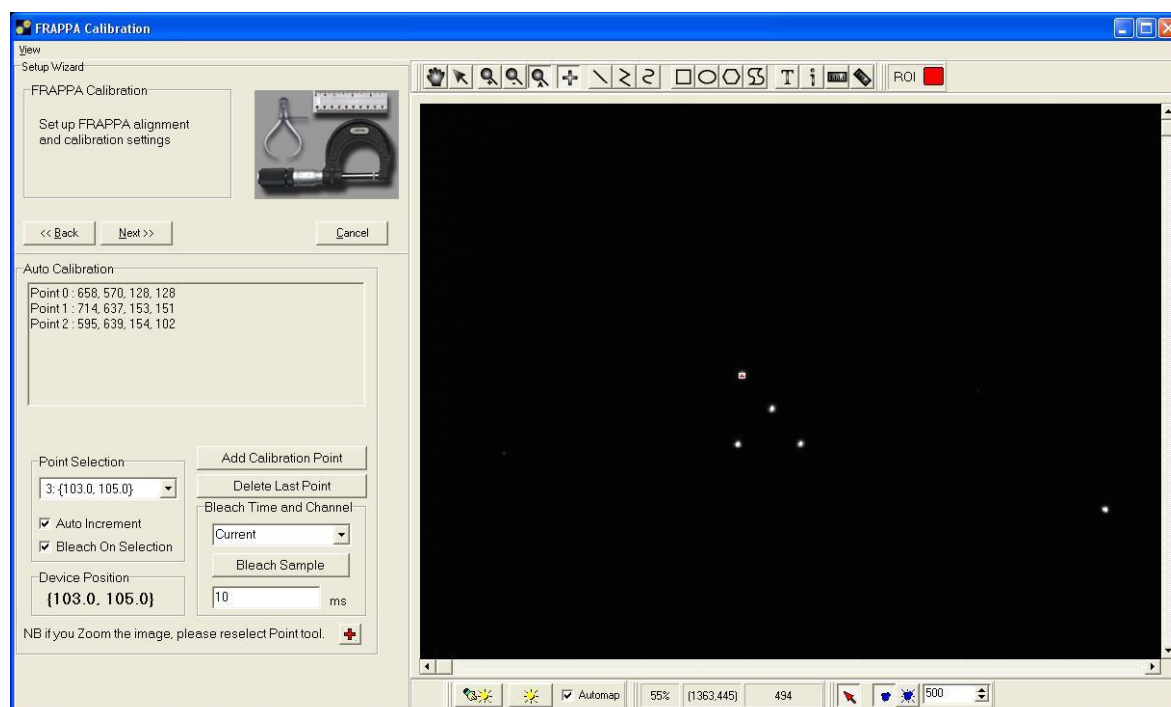

The MicroPoint device requires a minimum of **17 points** for an adequate calibration. When you are satisfied that you have sufficient points over the image, then click on Next and the FRAPPA Calibration will be created by the system and used henceforth whenever a FRAPPA action is requested/demanded.

5. Setting the FRAPPA focus control

Now that the FRAPPA system is calibrated in X and Y you can use it in “**FRAPPA on Demand**” mode. This means you can go live and use a FRAPPA region type with a FRAPPA on Mouse Up action.

Place a “+” FRAPPA region on the focused specimen image and right mouse on the region. Select the “FRAPPA on Mouse Up” option – when selected it will be checked. Assuming the calibration above is accurate, when you mouse up after moving the region the area immediately below the region in the specimen will be bleached.

Finally perform a series of FRAPPA tests within iQ making sure to test points and ROIs.

3.6.7 Mosaic Calibration

The Mosaic Device must be installed and aligned by a fully trained Engineer.

1. Preliminary setup requirements:

- A) we assume that you have an iQ **Configuration** that includes all the devices you wish to use (including the ALC with MPU), selected camera and CSU).
- B) Make sure that you have a suitable sample for photo bleaching – either **Andor Test Slide #001** or a fixed Molecular Probes© specimen e.g. Cells#2 where microtubules are labeled green – excited at 488 nm. Alternatively, Mosaic can use the first surface mirror that is provided with the system in order to properly calibrate the system. Mosaic illuminates a series of points or patterns that are reflected off the mirror and used for the calibration routine.
- C) Start **Andor iQ 2 or later** (exe dated July 28 10 or later).
- D) Make sure that Mosaic is connected on a suitable COM Port.

Note the FRAPPA calibration is independent of objective magnification, but depends critically on the camera orientation, alignment and pixel organization.

e) You may wish to create a Frap channel for Mosaic as with the FRAPPA, but this is not essential, as the Mosaic device is not in the light path, and you may use the **current** channel settings to Calibrate.

2. Run the FRAPPA Calibration Wizard from the Wizards menu. If there are multiple FRAPPA devices in the configuration, select the Mosaic – FRAPPA radio button to calibrate the Mosaic device. Choose to create a **New** FRAPPA calibration or choose the FRAPPA calibration you want to **Edit**.

3. Next, you may select the Manual checkbox if you wish to manually select a range of positions / points to calibrate, but **we recommend** you keep the Manual **checkbox de-selected** as this will automatically provide a list of positions / points which will deliver the best calibration for the device range.

4. The Calibration panel allows you to calibrate how the device range translates to camera pixels. This ensures that interactive FRAPPA operations can be executed at the correct position. Below the combo box of pre-defined device positions, if “Auto-Increment” is checked, the device will automatically move to the next position when the “Add Calibration Point” button is clicked for the current position. If “Bleach On

Selection” is also checked, the new position will be bleached, allowing the calibration to flow more easily.

Now with the specimen in focus, select a suitable Frap channel and click the Bleach Sample button. If the system has been pre-aligned, you should see in the image a region of the specimen which has been bleached. A bleached region will appear darker than the rest of the specimen and should be localized. **Note:** if the bleach

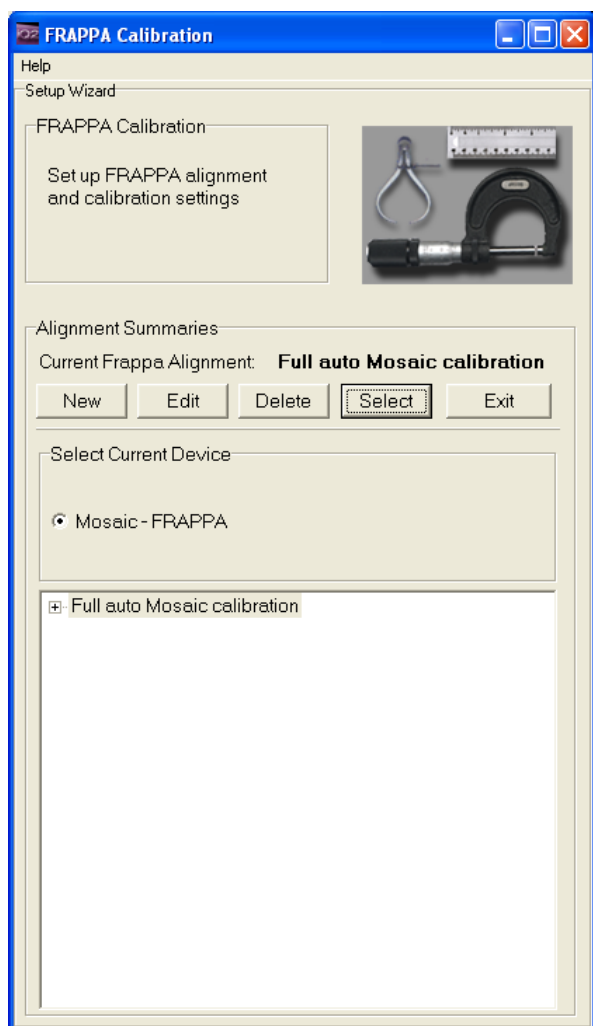

cannot be seen you may need to scroll the XY stage a little, or increase the FRAPPA time if the bleach is still not visible. This step of finding the initial bleach may be tricky the first time you calibrate the system.

Once the bleach spot has been identified (in the field of view), then you must create corresponding pixel coordinates and angles for the calibration procedure. To do this, for each bleach point (region), click on your best estimate of the region center (with the + marker) and then click on the button labeled “**Add Calibration Point**”.

The Mosaic device requires a minimum of 3 points for an adequate calibration. When you are satisfied that you have sufficient

points over the image, then click on Next and the FRAPPA Calibration will be created by the system and used henceforth whenever a FRAPPA action is requested/demanded.

5. Setting the FRAPPA focus control

Now that the FRAPPA system is calibrated in X and Y you can use it in “**FRAPPA on Demand**” mode. This means you can go live and use a FRAPPA region type with a FRAPPA on Mouse Up action.

Place a “+” FRAPPA region on the focused specimen image and right mouse on the region. Select the “FRAPPA on Mouse Up” option – when selected it will be checked. Assuming the calibration above is accurate, when you mouse up after moving the region the area immediately below the region in the specimen will be bleached.

Finally perform a series of FRAPPA tests within iQ making sure to test points and ROIs.

3.6.8 Multiple FRAPPA Devices

Andor iQ software allows control of more than one FRAPPA device. The following sections describe how to setup and select calibrations for multiple FRAPPA devices, how to create a multiple device protocol and how to select a required device when performing manual FRAPPAs.

3.6.8.1 Multiple Device Calibration

The following descriptions assume familiarity with section 3.6.5: FRAPPA Calibration Wizard.

Open the Calibration Wizard and select the device from the radio list, as shown in the diagram below. Now run through the Wizard steps as described for the particular device in section 3.6.5. Repeat this process if required, ensuring that you have a calibration for each of the devices you need control of.

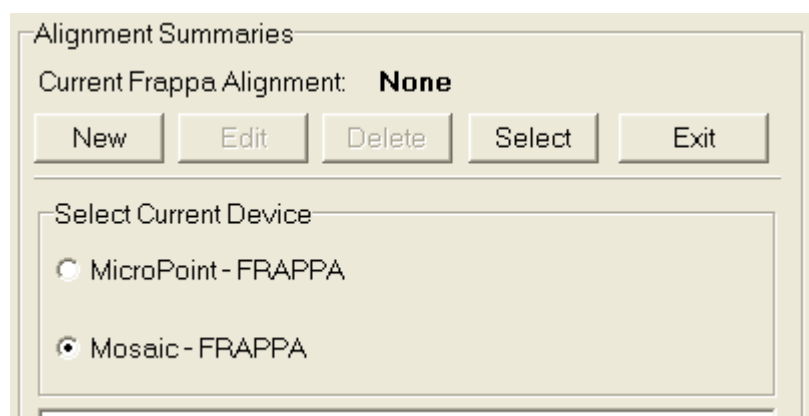

On creation of the calibration the 'Current Frappa Alignment' will be automatically

assigned to the new calibration:

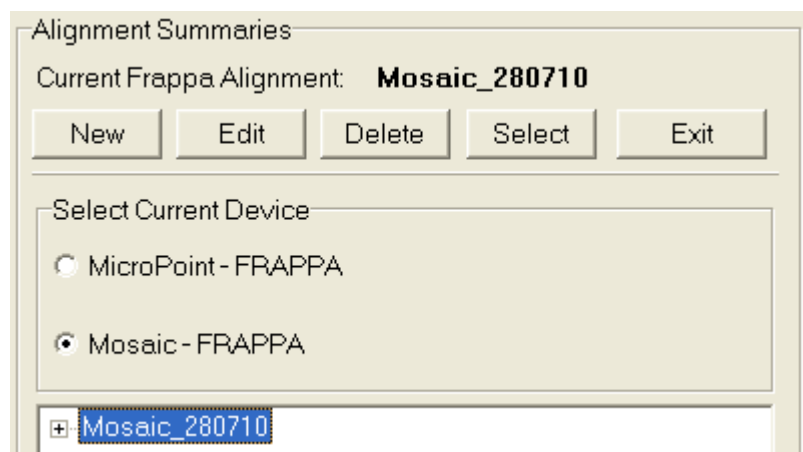

In order to control multiple FRAPPA devices iQ needs to know which calibration to use with each of the devices. If you have multiple calibration files for a device you can instruct iQ which one to use by selecting the device in the radio group, then highlighting the required calibration in the tree and clicking the Select button.

3.6.8.2 Multiple Device Calibration Dependency

Note that a device calibration may be dependent on certain other system variables and calibration may be lost if these variables change. For example, if a FRAPPA device has been installed in the optical path between sample and camera and a calibration is carried out for a rear mounted FRAPPA device (e.g. the Mosaic or MicroPoint) then the calibration may be lost if a different FRAPPA calibration is selected which changes the FRAPPA registration position.

3.6.8.3 Including Multiple FRAPPA devices in a protocol

Multiple devices in a protocol are distinguished from one another via a device keyword. When the protocol switches to a FRAPPA channel the current device will switch to that indicated by the keyword and the selected calibration for that device will be used.

The device keyword is set in the 'Channel Select' dialogue which displays when a FRAPPA is inserted into the tree.

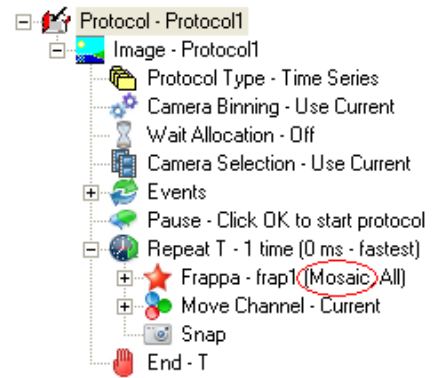
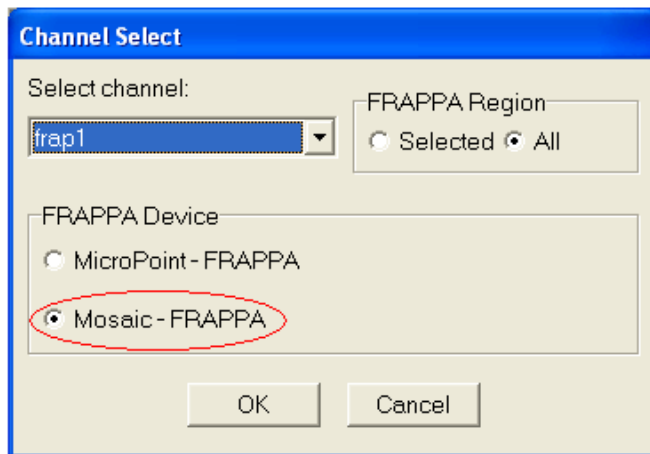

The second keyword, 'All' in the above example, indicates whether to FRAPPA the currently selected region or all of the defined regions.

3.6.8.4 Interactive or “Click and Fire” FRAPPA with Multiple Devices

When a FRAPPA region is selected on the ImageView the user can perform manual FRAPPAs via the right click context menu. If the user has multiple FRAPPA devices in the system he will need to set the current device. He can do this either in the 'Select FRAPPA Device' dialogue as selected from the 'Wizards' Menu, or more directly, using the right click context menu as shown below:

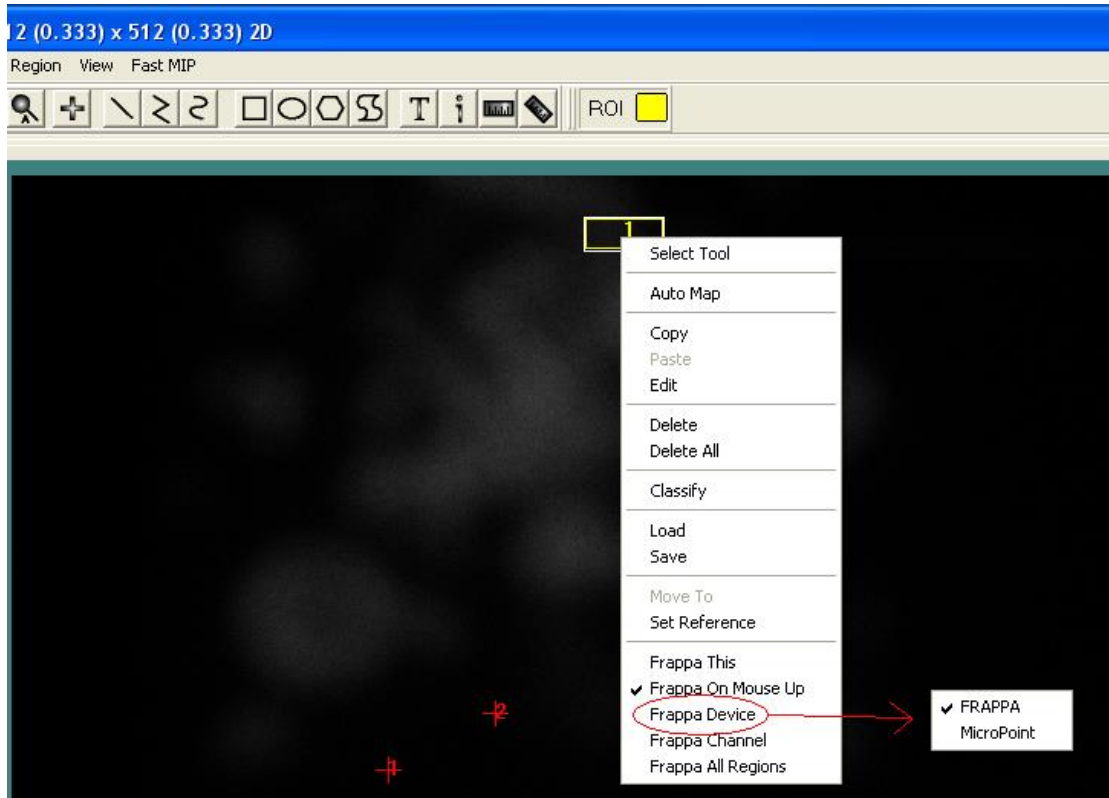



4 - Acquisition Tools

4.1 Configurations

When you create a **Configuration** in iQ you choose all of the hardware components you want to control. An example is shown in Figure 4.1.1. You can create multiple configurations for different scenarios and choose which one to use when you start iQ. More details on the Configuration Manager are available in Appendix 2.

In iQ 3 you **cannot use Fast LZ mode**.

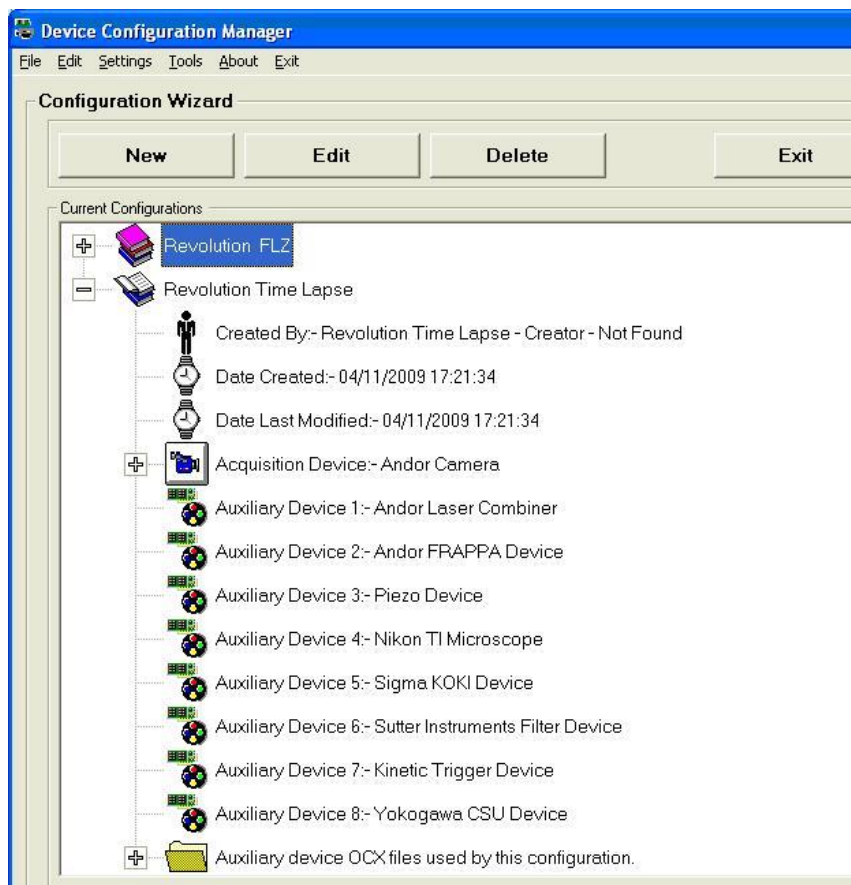
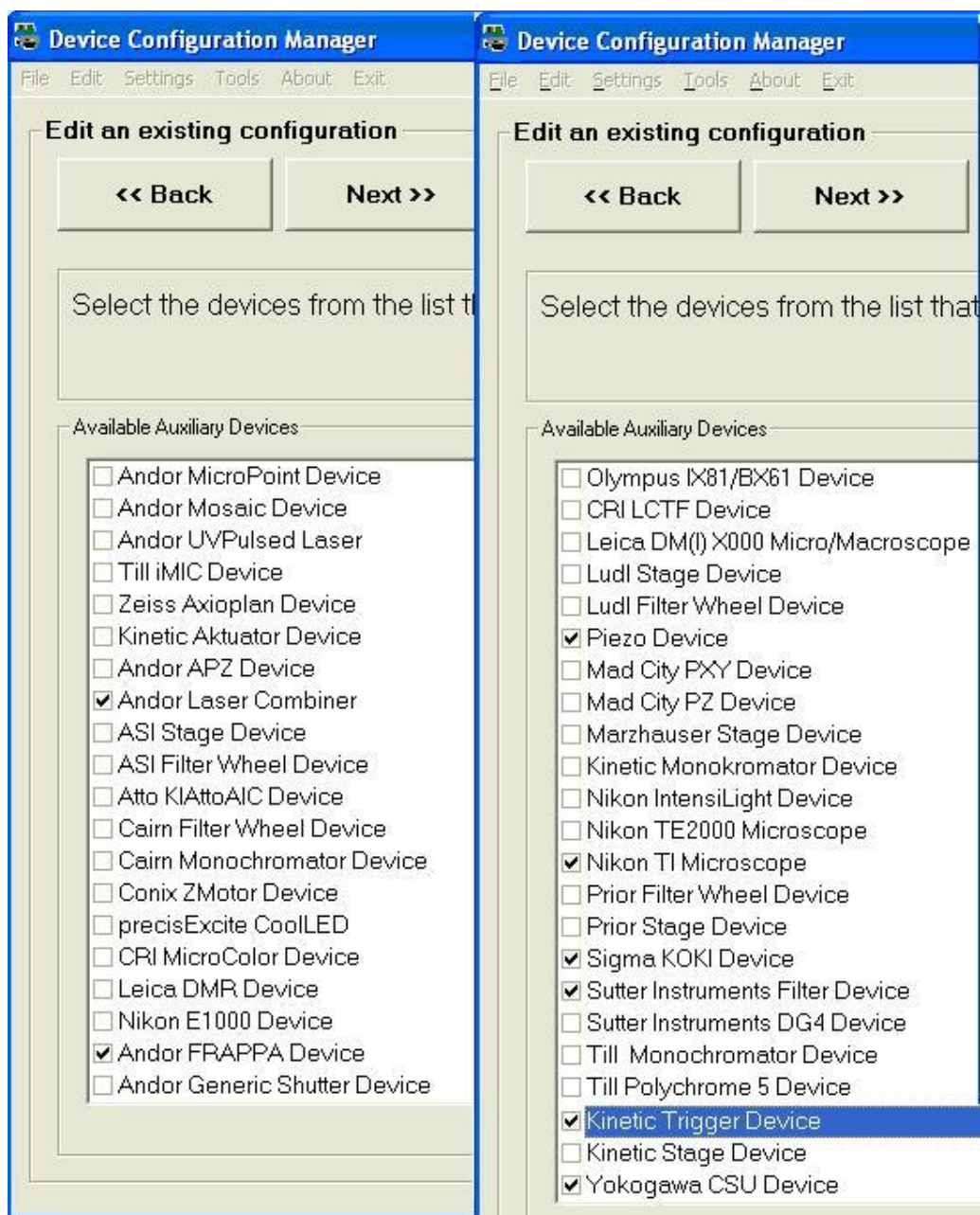

Figure 4.1.1 Configuration Manager shows a Time Lapse Configuration. Note that every device which is to be controlled must be listed in this Configuration. The Configurations will control the same devices in these two examples.

For details on how to import pre-existing Configurations, refer to **section 2.3.1.4** of this User Guide.

To build a new Configuration, select devices to control from the lists shown in the Configuration Manager, starting with the camera driver. Check the boxes against the selected devices as shown in the screen shot below.



4.1.1 6D User Interface

iQ3 delivers new intuitive 6D View which greatly simplifies the setup of complex protocols (up to 6D), providing an improved graphical user interface (GUI) look and feel. A single tab based GUI allows easy selection of Channels, Z, XY and Time settings. Because iQ3 supports sequencing of up to 3 repeat loops (multi-phase) and has the capability to define a reference channel (acquired every n^{th} frame), it is therefore possible to acquire data in both “regular” and “sparse” patterns (the tree view must be used to acquire truly “irregular” patterns). So for example, you can create a multi-phase acquisition with different acquisition rates in the different segments of the Protocol.

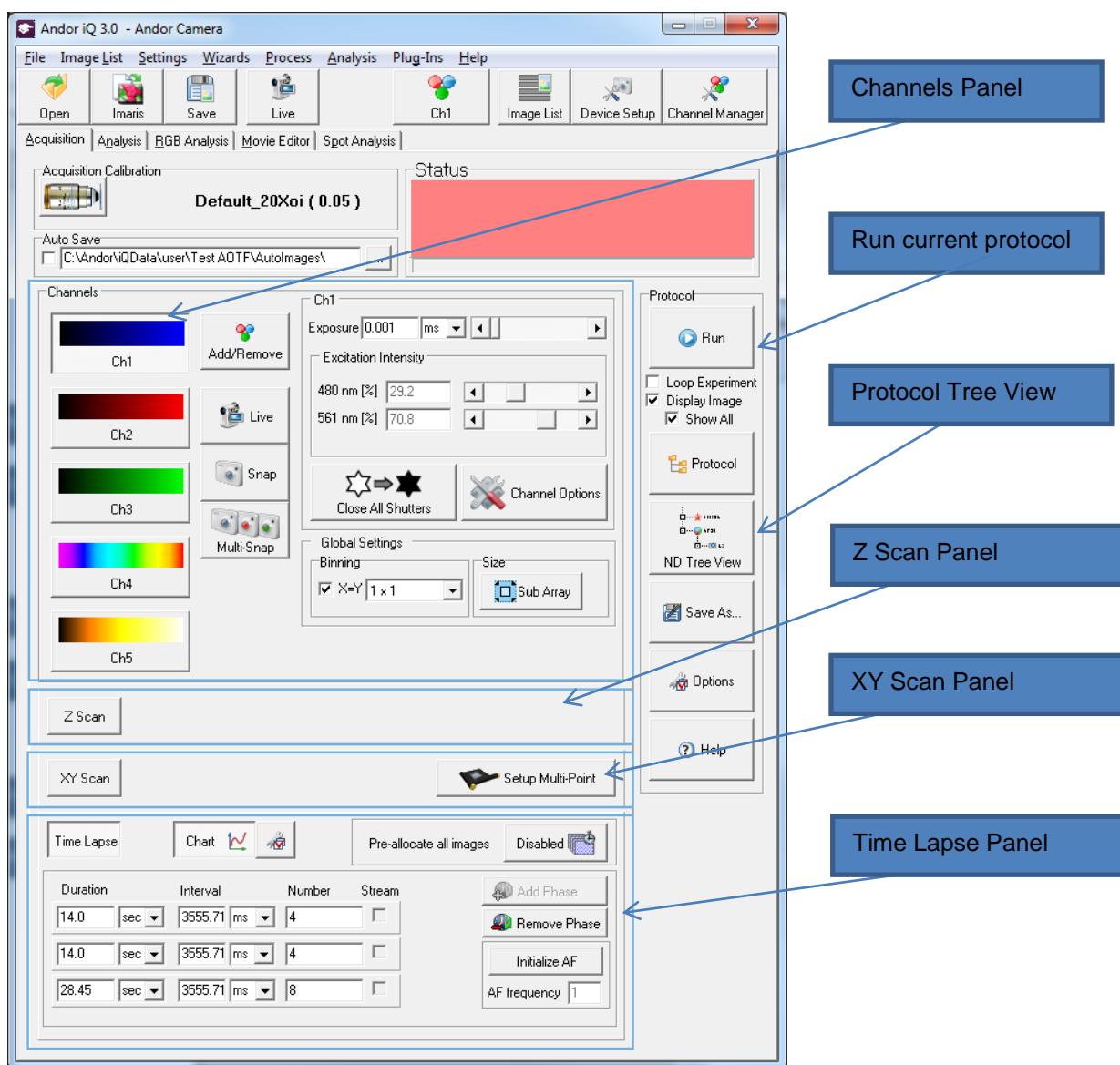

4.1.1.1 Channels Panel

In the Channels Panel a user can select channels (5 max) and adjust channel parameters for the current protocol. The user can also change the Global Setting for the experiment such as camera binning and image sub-array

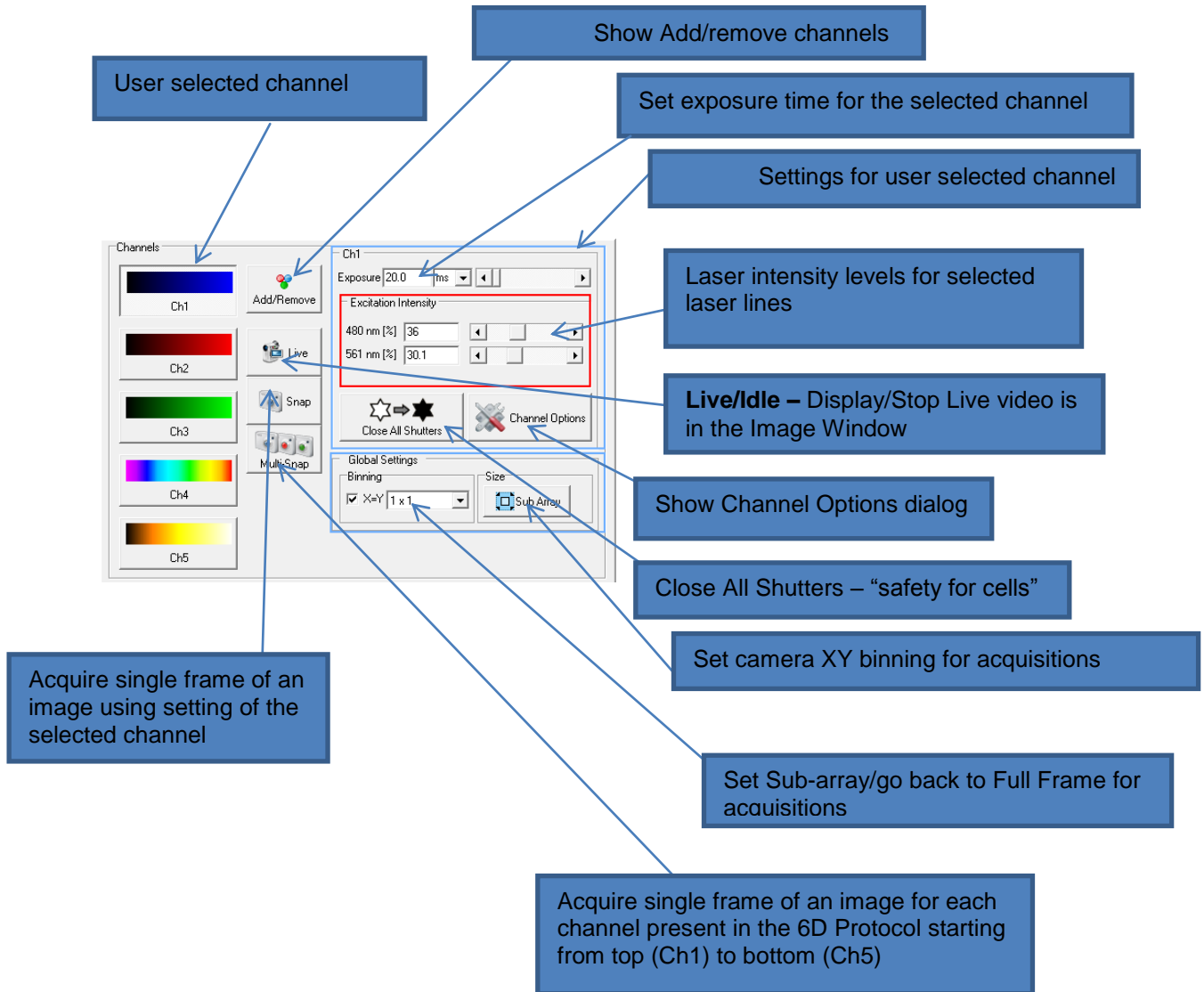

Excitation Intensity

Excitation Intensity scroll bars allow the user to change the laser intensity levels for the selected channel. This dialog only shows the laser lines that were previously selected under AOTF tab in the Device Setup dialog.

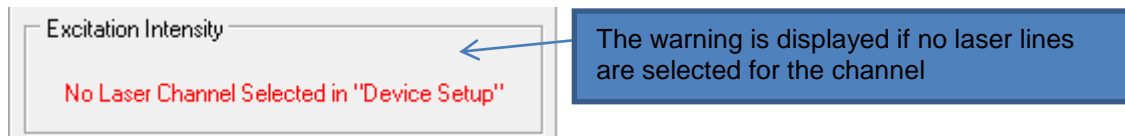

The user can select a laser line for the channel by ticking the appropriate check box as shown below.

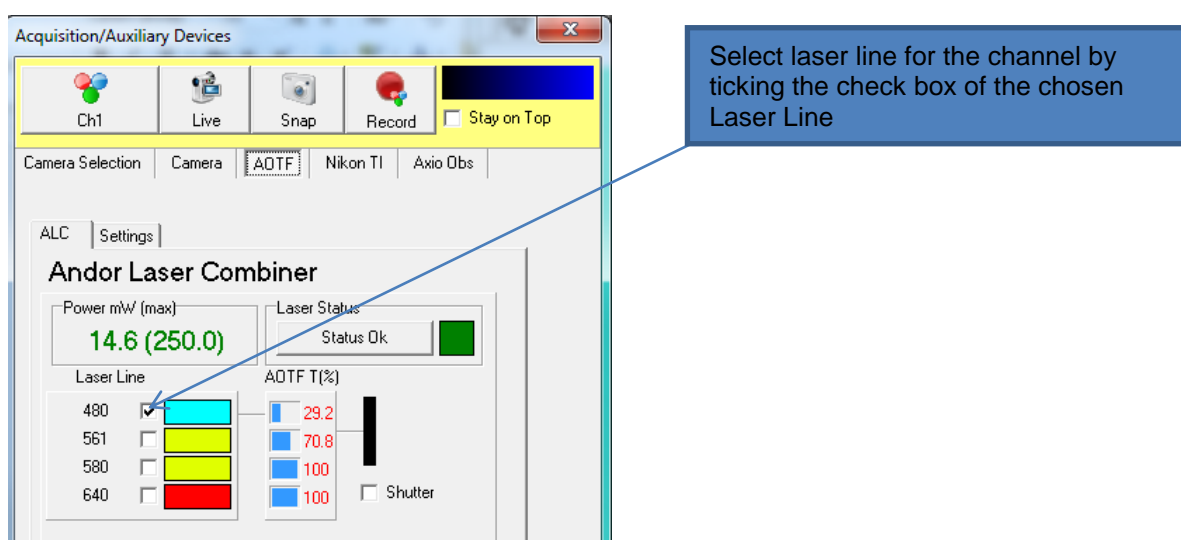

The user can select up to 2 laser lines for the channel.

Channel options

When the user clicks on “Channel options” button the channel options dialog will pop up allowing the user to set a reference channel. These options are only available for protocols with Time Lapse defined and the second option is valid for Z scan defined.

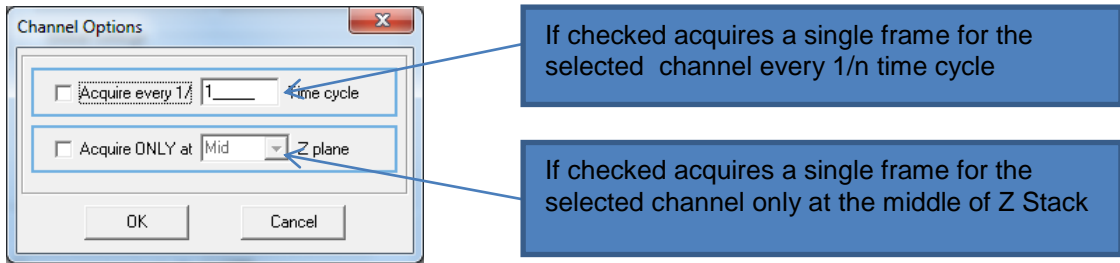

“Add/Remove” Channels

When the user clicks on “Add/Remove” button the Channel dialog will pop up allowing the user to select/unselect channels for the current protocol. The user can select up to 5 channels for the experiment.

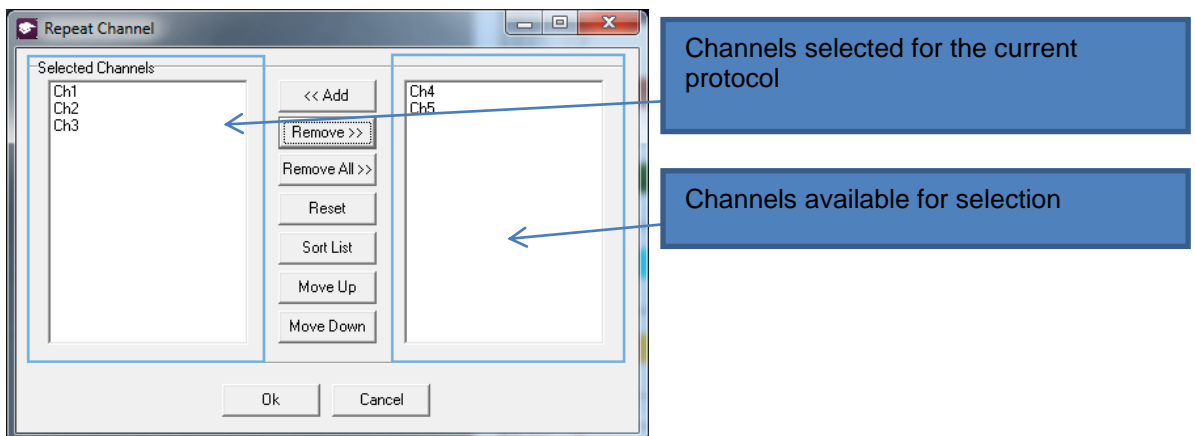

4.1.1.2 iQ 2 Protocol Tree View

When the user clicks on “ND Tree View” button the Protocol Tree View will show up. In order to come back to the 6D Protocol view uses has to click “6D View” button.

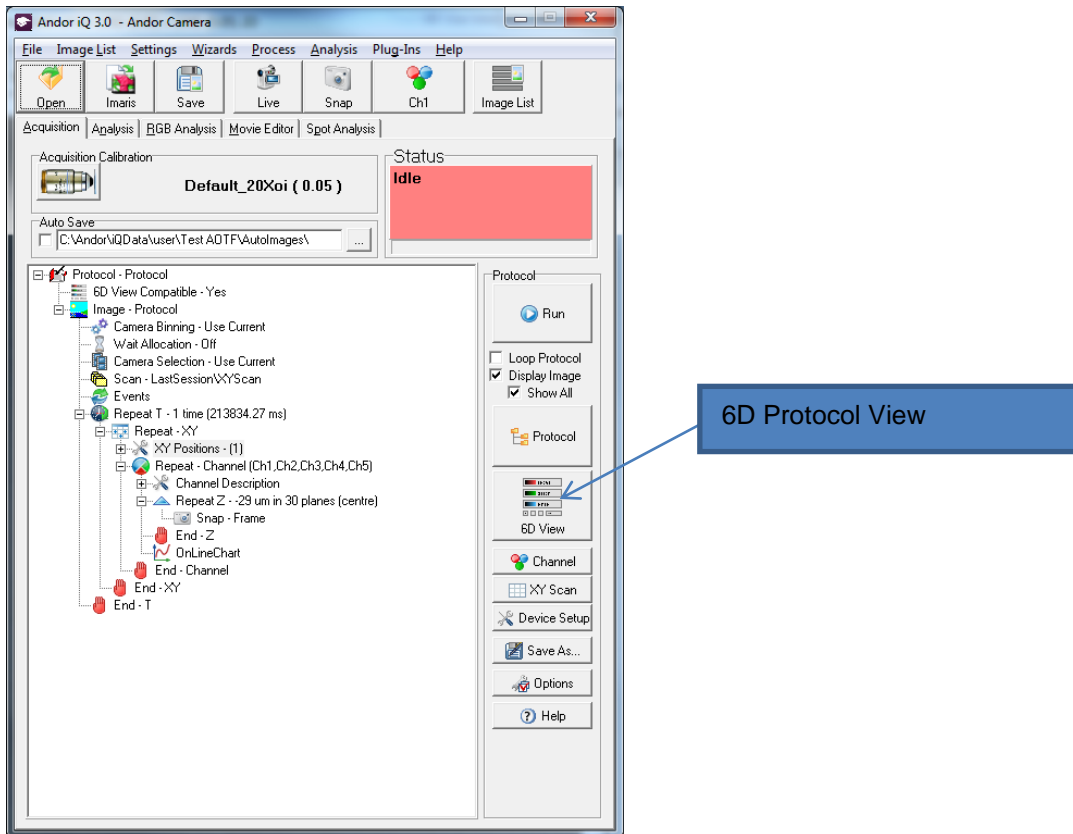

4.1.1.4 Z Scan Panel

For information how to set Z scan for the experiment refer to Z Scans sections in this document

4.1.1.4 XY Scan Panel

XY panel is now table based which makes it easier for users to review and refine scan patterns.

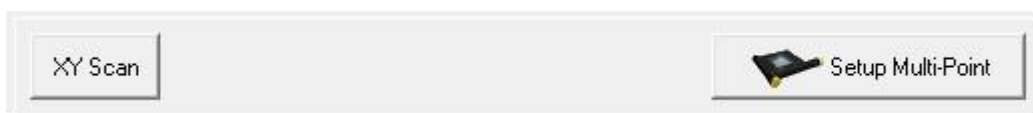

XY scan button will activate XY scan in the current protocol.

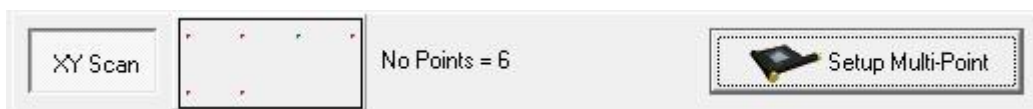

The panel displays an illustration of the current scan pattern and also shows the number of fields.

Modifying a scan pattern

To define the scan pattern click Setup Multi-Point

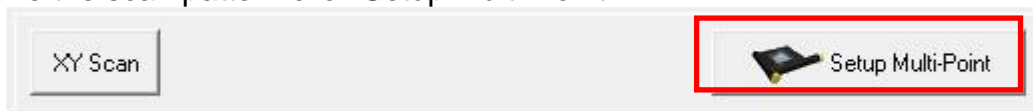

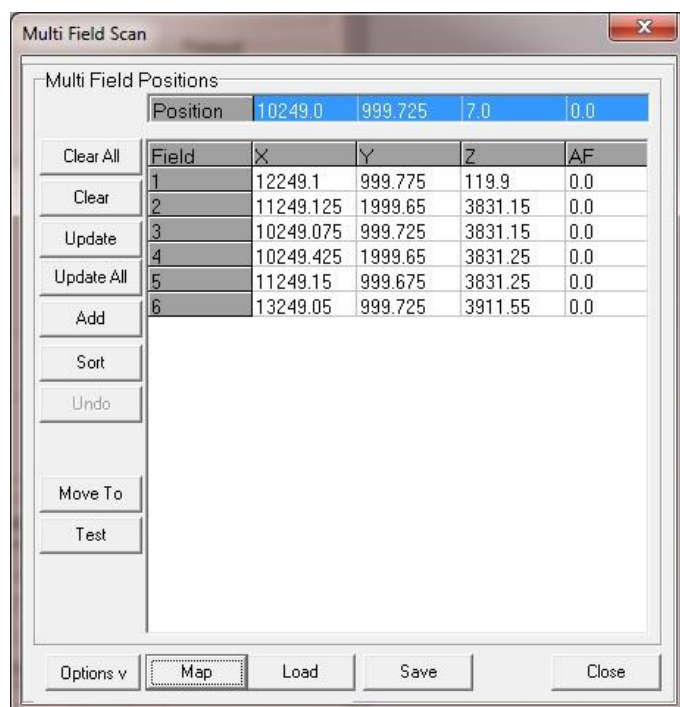

Clear All – delete all entries

Clear – delete the selected entry

Update – record the current stage position into the selected entry

Update All – as Update but will also calculate the change made to the field position. The difference is then applied to all other fields. This is useful for making quick adjustments due to XY or Z drift.

Add - record the current stage position into a new entry at the end of the list

Sort - Shortest route calculator means that the scan is executed in the most efficient manner.

Undo – rewind any changes made in the dialog such as Add or Sort

Move To – quickly move to the selected field. Note that there is an option to move on double click.

Test - allows quick review of the fields of interest. Note that this may also be useful for rapid scanning of a sample when looking for a field of interest (exhibiting behavior to be studied). Once detected, stop the automatic movement of the stage and then execute a protocol to record the behavior.

Entries will record the XY and Z position of the stage. Where applicable an addition focus drift compensation parameter will also be recorded (several motorized scopes), allowing long time lapse protocols to be executed without the fear of losing valuable data due to miss focus.

Map - A touch of the button switches from grid to graphic view.

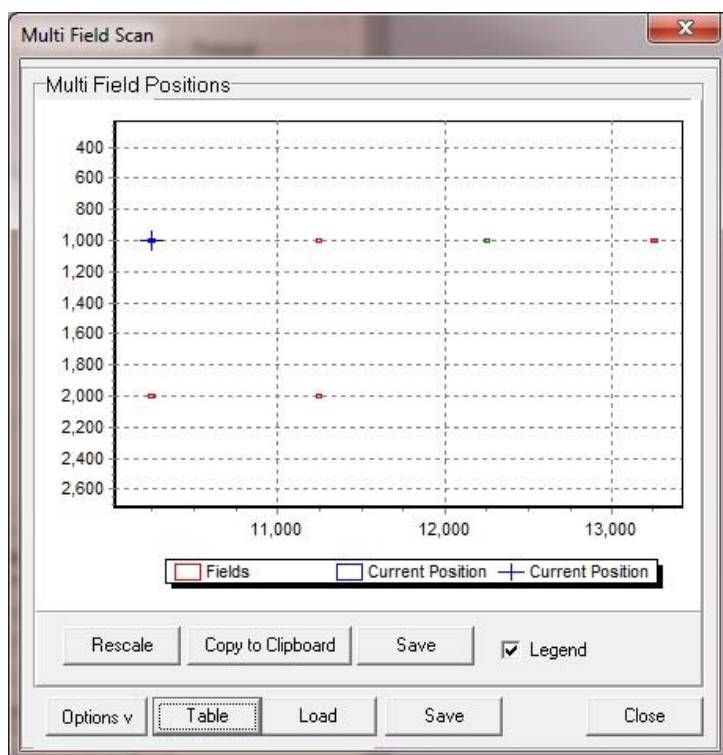
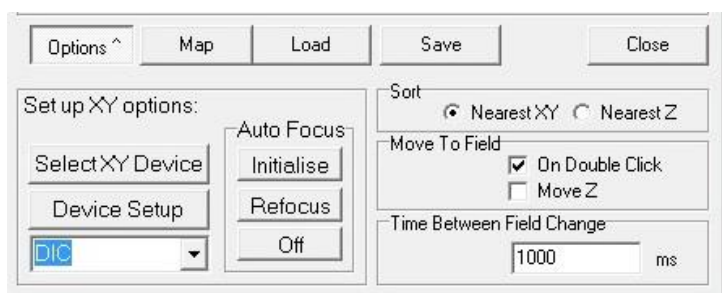

Table – will return to the Grid view

Load and Save - allow the scan to be saved to disk

Options – Will show/hide the option for the dialog



Sort – options for the sort algorithm

Move to Field –

On Double Click - will move to the selected field when double clicked.

Move Z – will only move the z device when selected.

Time between Field Change – time between fields when reviewing fields (see Test above).

Note that this scan panel does not support Multi-Well or Montage, for these features please use the Scan Wizard under the ND Tree View.

4.1.1.5 Time Lapse Panel

When the user click on the “Time Lapse” button the Time Lapse Panel expands allowing the user to set single or multiple Time phases for the protocol as well as some other options such as Auto Focus, On-line chart and Pre-allocate all images.

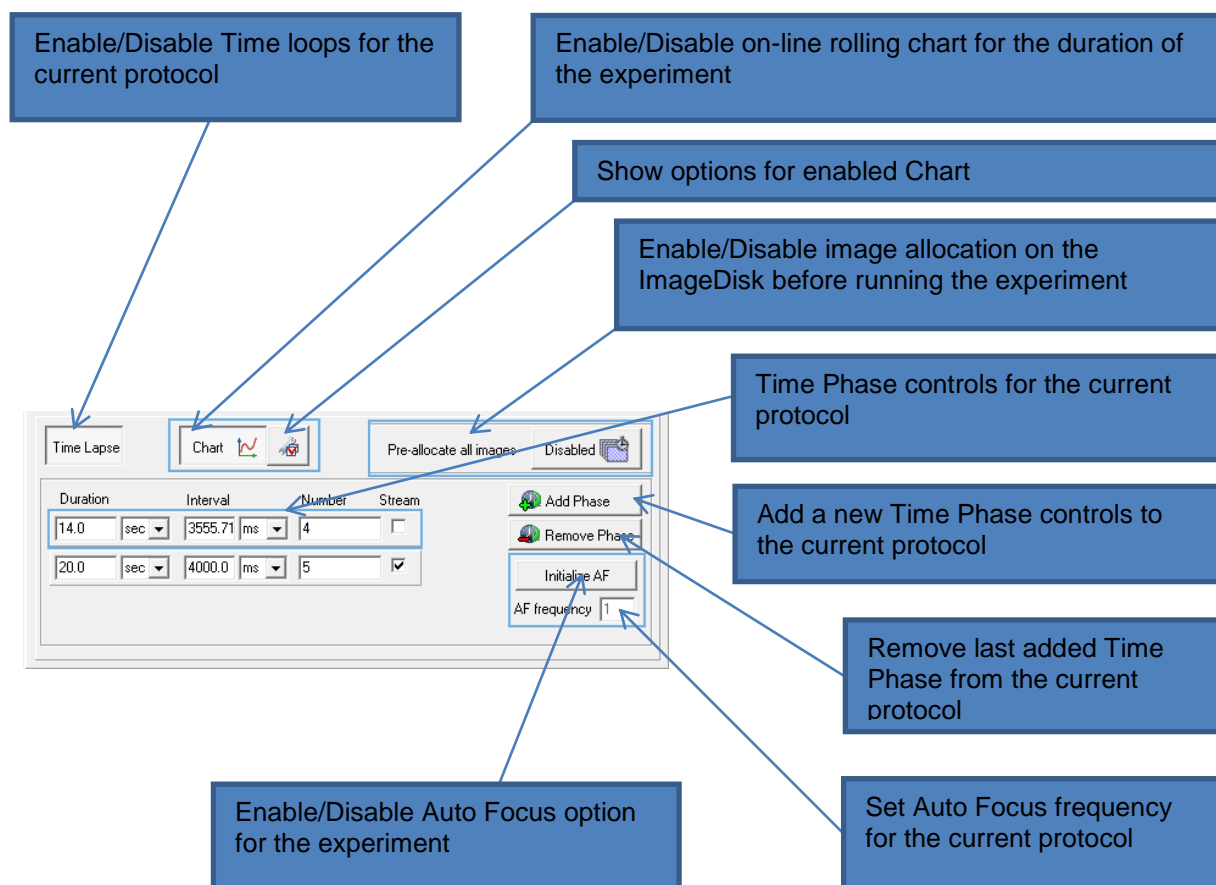

Time Phase Controls

In the Time Phase Controls panel the user can change time duration, time interval, number of time points and select snap mode for the current protocol.

Duration

In order to change time duration the user should enter a value in Duration edit box. Note that changing Duration will update the number of time points in Number edit box using the calculation $\text{Number} = \text{Duration} / \text{Interval}$.

Interval

In order to change time interval the user should enter a value in Interval edit box. Note that changing Interval will update the number of time points in Number edit box using the calculation $\text{Number} = \text{Duration} / \text{Interval}$.

The user is not allowed to enter the value below the minimum interval value which is calculated based on the exposure times of the currently selected channels, number of Z planes if Z scan is enabled for the experiment and number of XY points if XY scan is available for the experiment. The minimum value can never be below 10ms.

Number

In order to change number of time points the user should enter a value in Number edit box. Note that changing Number will update the duration value in Duration edit box using the calculation $\text{Duration} = \text{Number} * \text{Interval}$.

Maximum number of time points for the experiment is limited by number of the currently selected channels and number of Z planes if Z scan is enabled for the protocol.

Stream

In order to set Snap to Stream mode the user should tick the Stream check box. Note that the Stream mode is only available when a single channel is selected for the protocol otherwise the Snap is set to Frame and the check box becomes disabled. The Frame mode is always the default mode for the protocol and also whenever the user unchecks the box.

4.1.2 Getting Started with Acquisition using nD tree view interface

When you first start iQ3 it is by default in 6D view and you can then switch to nD tree view. If you have not transferred iQ2.X Protocols using protocol importer, as outlined in A5.27 then iQ3 will start up with a default Protocol as shown below. In this case only the Channel “Current” will exist. “Current”, as the name suggests, takes whatever settings are *currently* assigned to devices in the Device Setup dialog. This

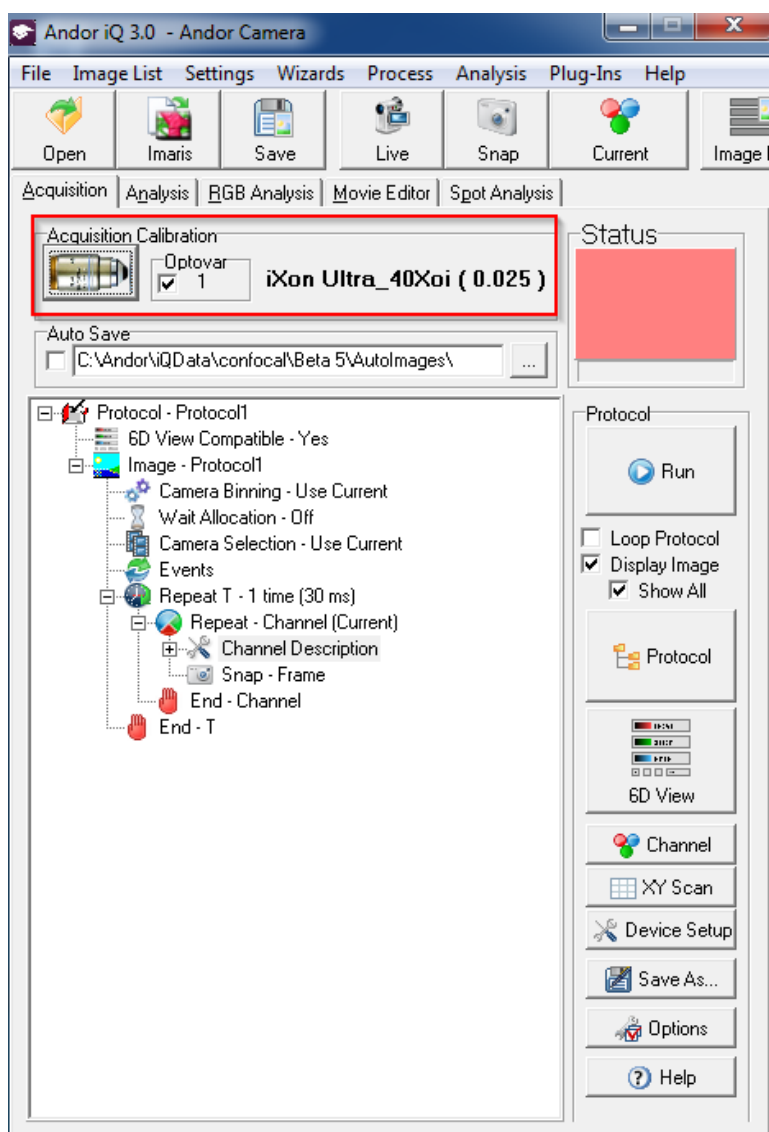

default Protocol lets you start using iQ3 to acquire time series data right away. You can adjust the camera and other device settings at will and Edit the Protocol by changing editing Repeat T loop parameters Number and Interval.

Be sure to select the correct Calibration setting for the microscope objective in use. During Calibration you can add an Optovar magnification setting. You can check Optovar “in” or “out” with the checkbox - see blue rectangle on left screen shot.

More sophisticated multi-channel and multi-dimensional sequences can be easily created. Read on to find out more about Channels, Scans and Protocols. These Topics are covered in the following sections.

4.1.3 How to Acquire a Single Frame Image

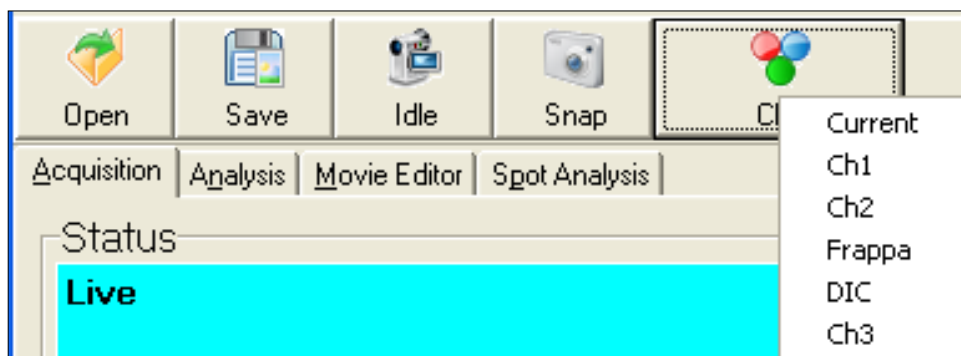

Select the **Acquisition** tab.

To see a Live Image from your camera press the **Live** button, which you will see toggles to **Idle**, indicating that pressing again will stop live imaging. The Status panel changes color to Cyan when live. To acquire a one frame image press **Snap**. This can be activated whether in Live or Idle mode.

If you click on the Channel button a pop-up menu appears showing **Channels** available to the current user. If you select a **Channel** then the hardware devices will move to the positions specified for that channel. In **Live** mode the system show a Live image of channel. On pressing **Snap** an image will be acquired, after which all post frame events will occur such as all shutters will be closed.

For more complex image acquisitions you will need to set up a **Protocol**. Before you can do this, a valid XY Calibration ([Section 3.2](#)) must be loaded and appropriate Channels ([Section 4.2](#)) and Scans ([Section 4.3](#)) must be defined.

4.2 Channels and the Channel Wizard

In the Acquisition Dialogue ([Section 2.7.1](#)) press the Channel button.

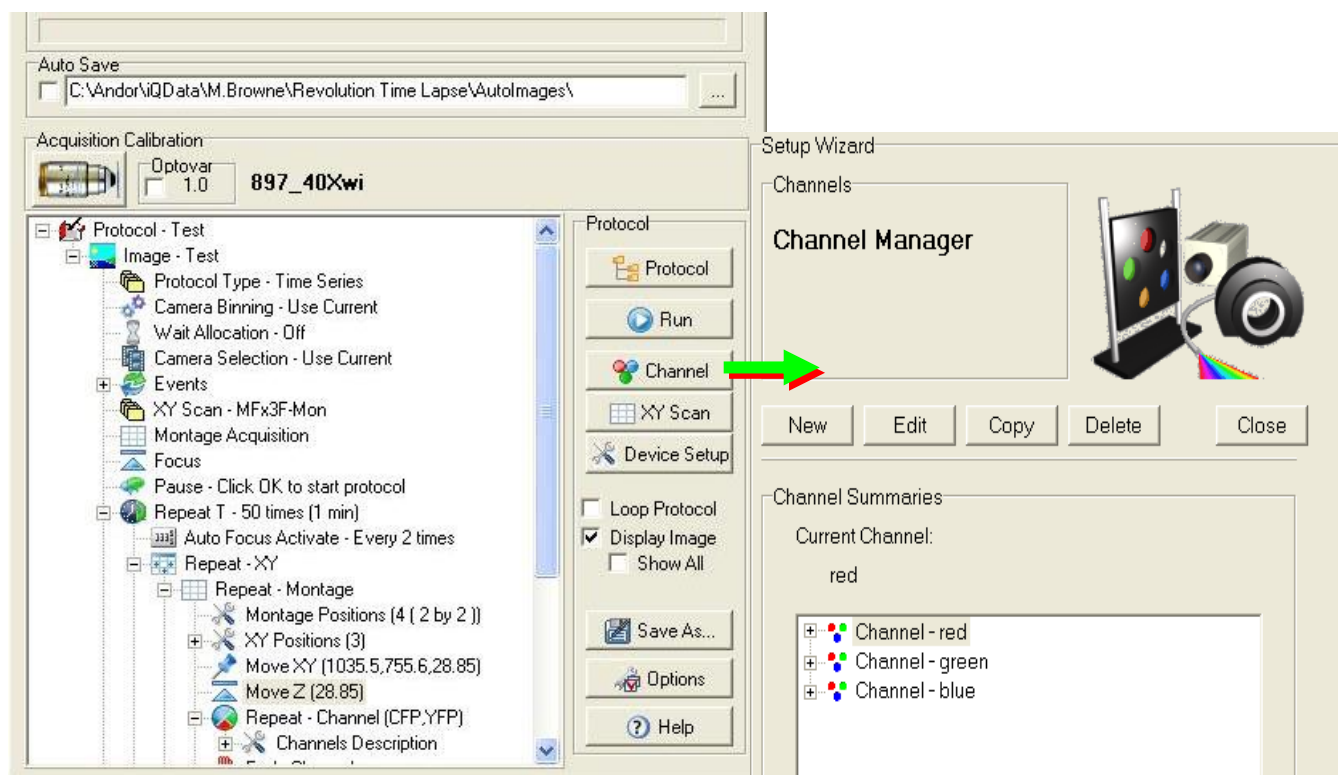

The dialog above shows a nD Protocol Tree, which is used to specify the sequence and timing of instrument controls functions, including movements of stages, excitation sources, emission detector optics, triggering and actions such as photo-bleaching. Channels define the system state required to create an image on the camera of a chosen fluorophore including illumination ports and techniques and usually will be set prior to a Snap action, which opens shutters, exposes the camera, acquires the image data and closes the shutter. Channels also contain image display information such as look-up-table (LUT) for pseudo color display and mapping (max-min range) settings to ensure good image rendering.

This opens the Channel Manager where channels are set up and stored. All existing channels are listed here for the current user.

Press the **New** button to continue.



Enter a name for the new channel into the text box.

The channel will be private to the current user unless the administrator is creating it, in which case it will be available to all users using the same Configuration.

It is recommended that the channel name should describe the fluorophore and/or imaging mode where possible.

Press **Next** to continue through all connected devices. This depends on your hardware configuration. Set each device settings as desired.

4.2.1 Important Note about shutters



Various devices have shutters e.g. filter wheels, ALC, CSU. The state of the shutters must ensure that the desired imaging path is “open” for illumination and detection. To minimize specimen exposure and the side effects of photo-bleaching select the Open-Close Option for the fastest shutter in the path.

Set slower shutters in the light path to the Open state and then they will not introduce unnecessary delays to every acquisition. An example of a filter wheel Channel Wizard dialog with shutter set is shown left.

The **Shutter Experiment Action** state for shutters is only seen in the Channel Wizard hence all Channels must be created in the Wizard, but can be edited -bar shutters - in the Device Setup dialog:

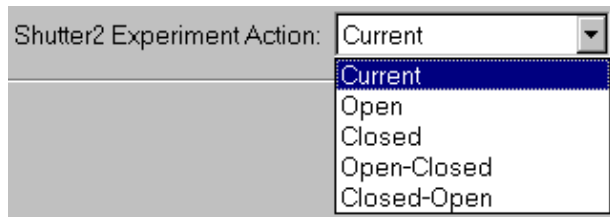

The experiment action for the shutter is selected from the drop down list.

- Current** - the Shutter will not move
- Open** - the Shutter will be opened immediately before channel acquisition and remain open until another channel closes it.
- Closed** - the Shutter will be closed immediately before channel acquisition and remain closed until another channel opens it.
- Open-Closed** - the Shutter will open at the start and close at the end of the acquisition of each channel of the image
- Closed-Open** - the Shutter will close at the start and open at the end of the acquisition of each channel of the image

Press **Next** to continue.

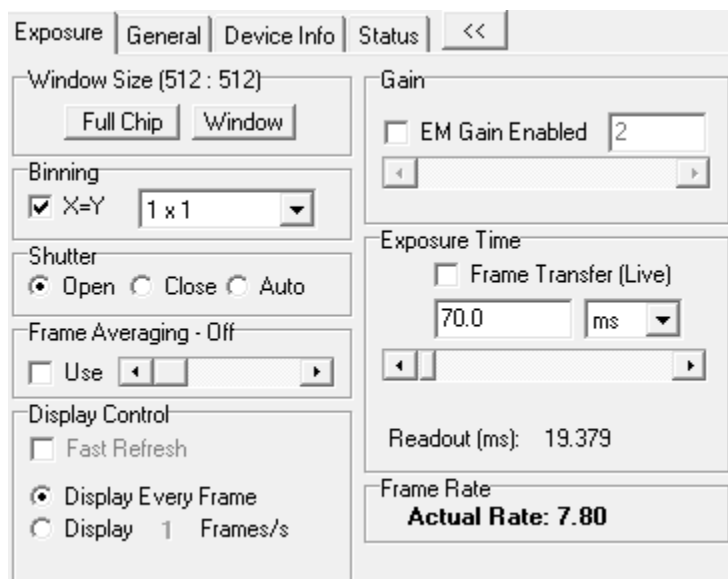

Finally, you will be prompted to configure your Camera, which in this example is an Andor iXon. The Wizard camera control panel is shown left. Deeper levels of camera settings are treated as global and not recorded in the **Channel**.

Pressing **Live** will display a live image enabling interactive setup of the camera. The controls include Pre-Amp Gain, EM Gain and Exposure time. Higher EM Gain can be used to reduce exposure time in low light level applications. For some applications good image

quality can be obtained by adjusting only the exposure time. Higher EM Gain will reduce dynamic range but can completely overcome any read noise in the camera. See **Appendix 3** for further information regarding different camera setups.

The Channel settings include a Look Up Table (**LUT**) or palette which is applied to images acquired with that Channel's settings. When contrast or Mapping (**Section 4.2.1**) is adjusted Live in the Wizard the settings are Recorded in the Channel. This ensures images are displayed with satisfactory contrast.

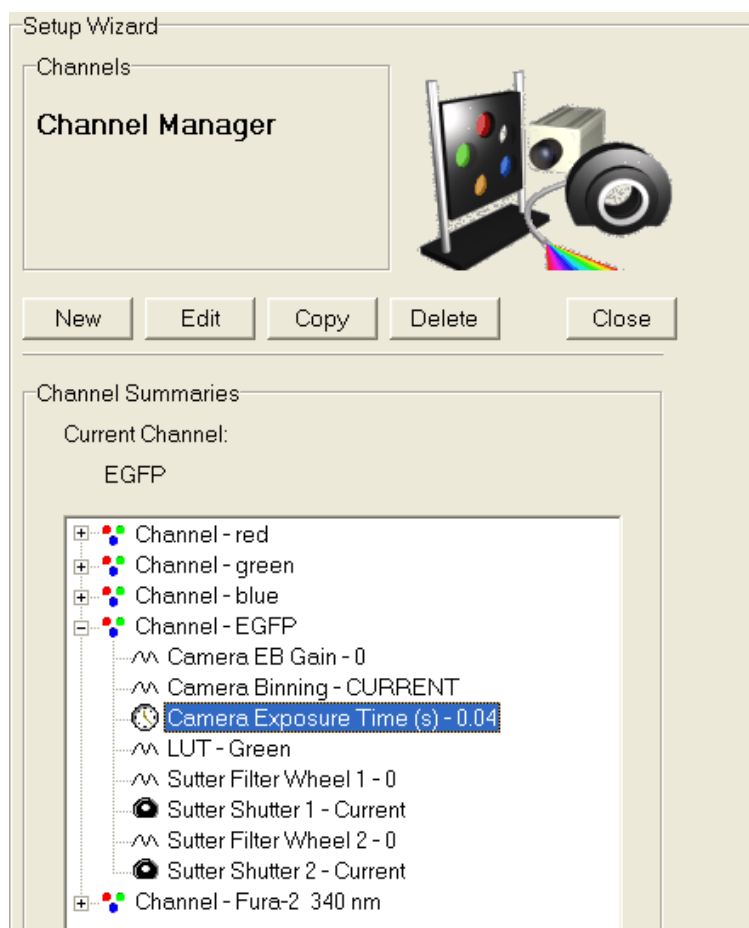

Press **Next** to continue.

The Channel setup is now complete. The new channel is listed in the Channel Manager – a click on the + sign displays summary information about the channel as illustrated below.

Press **Close** to exit the Channel Manager. The channel can now be incorporated into a Protocol.

4.2.2 Important Note - EM Gain and Multi-Channel Imaging

Many Andor and third party systems are supplied with Andor's award winning EMCCD cameras (<http://www.andor.com/>). **When EM Gain is used in multiple channels in the same Protocol, EM Gain must be EQUAL in ALL channels.** EM Gain switching takes time to settling (a few hundred milliseconds) and if switched between channels may not have time to stabilize before the exposure is started (or completed). The result will be poor quality or even missing data.

4.3 Scans and the Scan Wizard

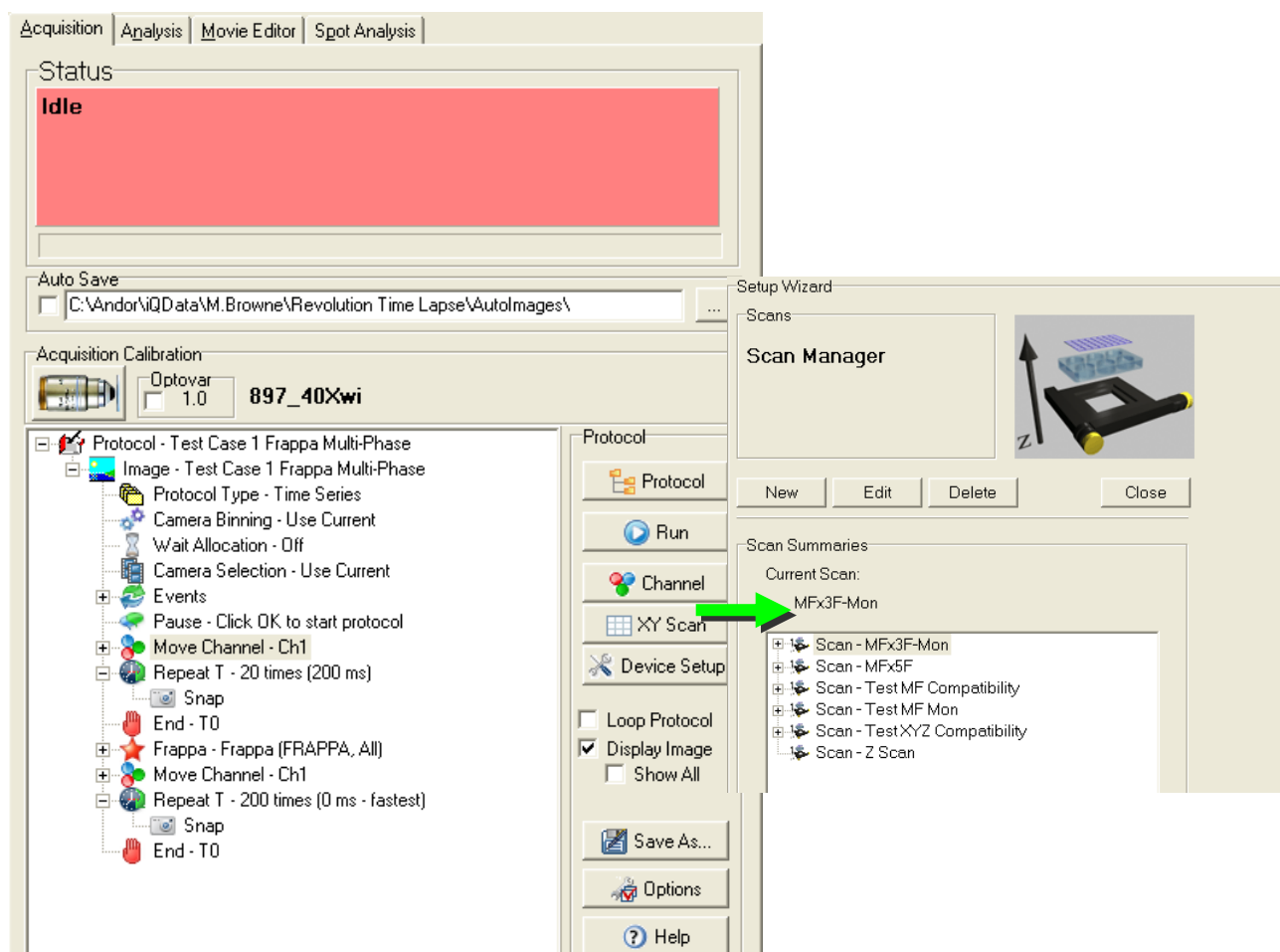

The dialog above shows a nD **Protocol Tree**, as described in the previous section. **Scans** can be **INSERTED** into this tree at the **Repeat** keyword by clicking the right mouse button and selecting **Scan** from the displayed list of **Action** keywords. You then choose from the list of existing Scans. To create a new Scan you must have a motorized XY and/or Z device under iQ control.

On the Acquisition page press **Scan** to open the **Scan Manager**. Press **New** to create a scan and the dialog left will show.

IMPORTANT: ALL Multi-well and Montage scans require that the system has been calibrated with **Stage Alignment Wizard (Section 3.2)**. Resulting scan patterns will not be correctly aligned and well sequencing may be incorrect if you fail to complete this step.

Please note that not all of the options above may be listed for your system. The

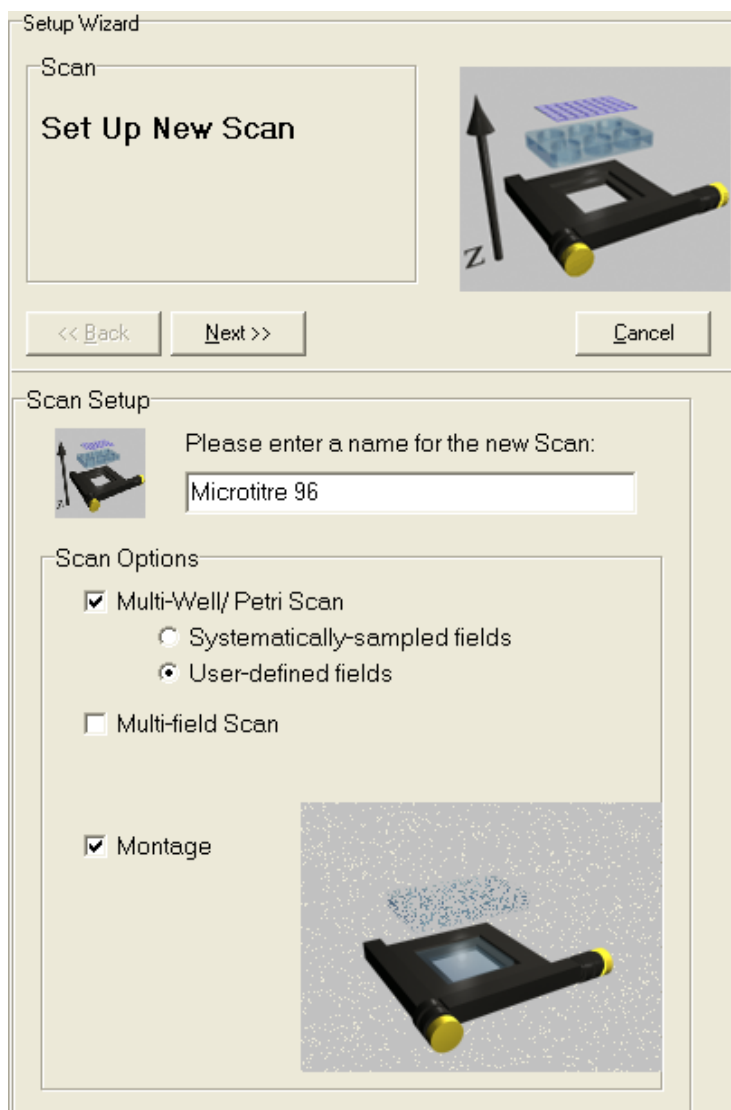

scan list depends on the hardware devices available and whether you have a license for multi-field or multi-well scanning.

The Procedure for creating scans is shown in a convenient flow chart format in figure 4.3.1 on the next page. The list of scan types supported in Andor iQ includes:

- **Multi-field or multi-point** (user defined fields of view).
- **Montage** allows several fields to be scanned and “stitched” together to increase the field of view for larger specimens, while maintaining resolution. Montage patterns include **Rectangle** - NxM fields; **Edge** - NxM fields are fitted to user-defined feature edges (boundaries); and **Linear** – a series of fields along a user-defined line specified by fields at the ends of a feature.
- **Multi-well** scanning is used for **micro-plate** or **multi-slide** patterns e.g. useful for multi-treatment experiments. Multi-well allows capture of multiple

fields per well, using either **systematic sampling** or **user-defined** fields.

- Multi-field and Multi-well can be extended with a Rectangle Montage at each field position.
- Multi-field, Montage and Multi-well constitute the XY scans.
- XY scans can be combined with Z scans to study e.g. 3D development.
- XY scans can be enhanced using Autofocus to correct for stage drift over time.
- **Autofocus** settings must be recorded at each field during field selection for proper operation.
- Autofocus support currently includes Olympus ZDC, Nikon PFS and Zeiss DF systems.

When you decide to create a new scan pattern, enter its name into the text box. Make sure you use a descriptive name to aid your memory if you wish to re-use them in future. Select the appropriate Scan Options by enabling the relevant check boxes. Press Next to continue.

As examples using the Scan Wizard, we illustrate creation of Multi-field, Multi-well with well rejection list and Montage scans. We hope that with a little practice the Wizards will become easy to use.

Note on Z Scans: Although only one XY scan can be used in a nD Protocol Tree, it is possible to use multiple Z scans. Whenever you Insert (or Edit) a Repeat Z in the Tree you will be taken to the Z scan Wizard to define Start, End and Step size of the scan as shown in [section 4.3.2](#). When you click Next you return to the Tree view. Note that ALL Z scans are **relative not absolute**. The currently Z position is used as the center of the Z scan rang

4.3.1 Flow Chart of Scan Setup and Options

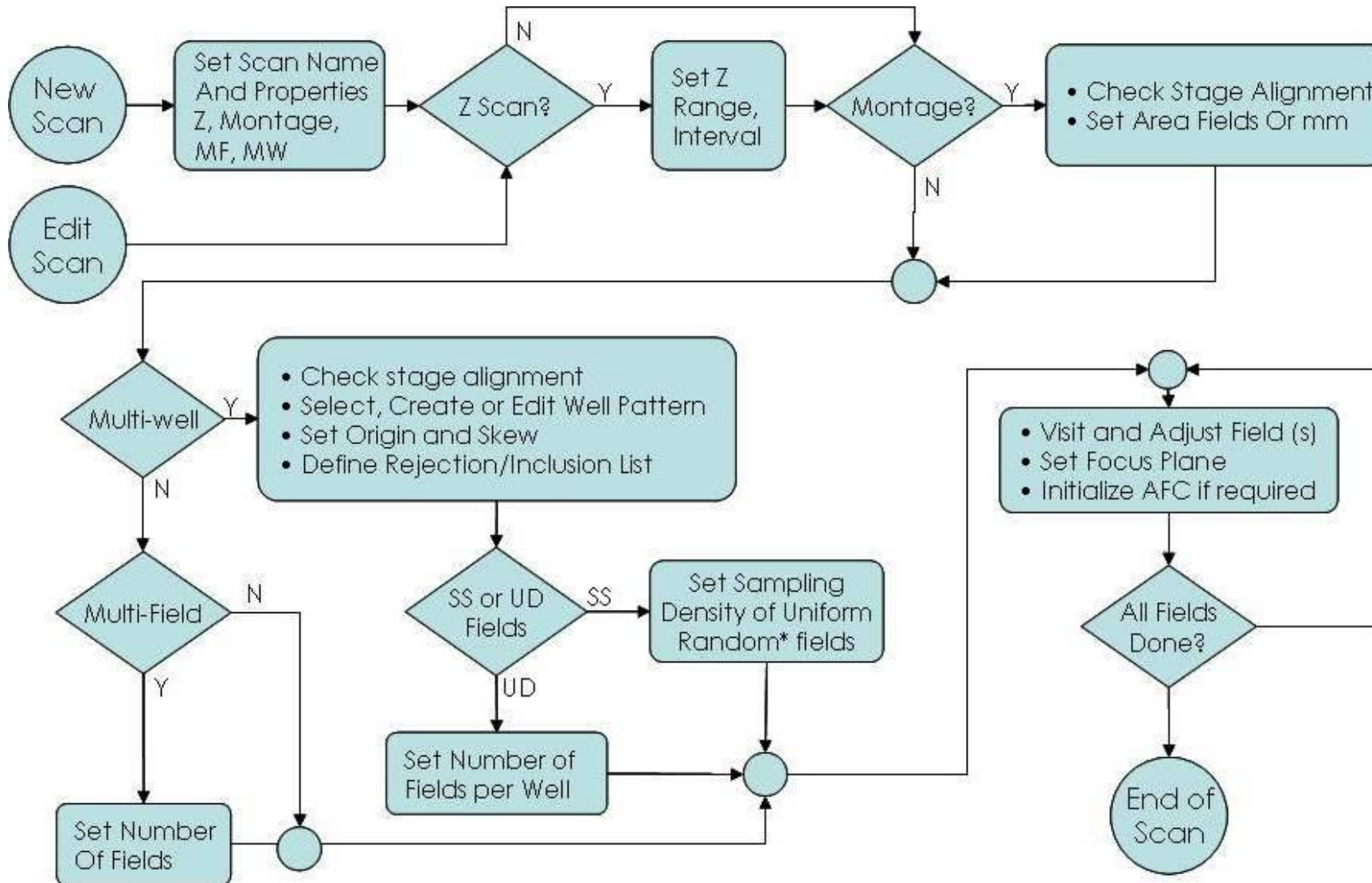

4.3.2 Z Scans

Z Scan Panel:

Z panel has been redesigned to provide an intuitive and improved user experience. The Z scan button will activate Z scan panel from 6D view.

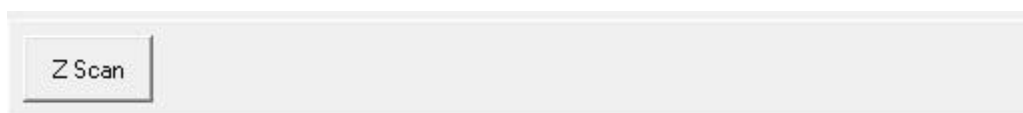

The panel will also be displayed in the scan wizard when you Insert (or Edit) a **ZRepeat** Action within the nD tree view.

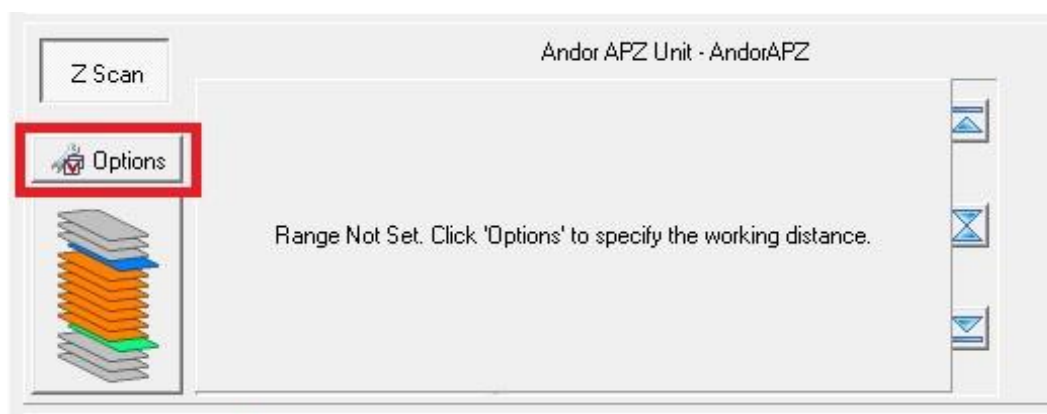

The selected Z device, used for Z scanning, is displayed at the top of this panel. If this is the first time that you have used the device with the Z scan wizard, you are prompted to specify the working distance. Select "Options" to define the working distance.

Options

The title of the dialog specifies the current Z scan Device.

Live Channel – selects the channel to be used for setting up the Z scan.

Z Move – Whether to complete all Z moves before changing channel.

ZRange – Shows the working distance for the device. The settings button will start a wizard which will allow you to define the working distance.

Select Z device – used to change the Z scan device.

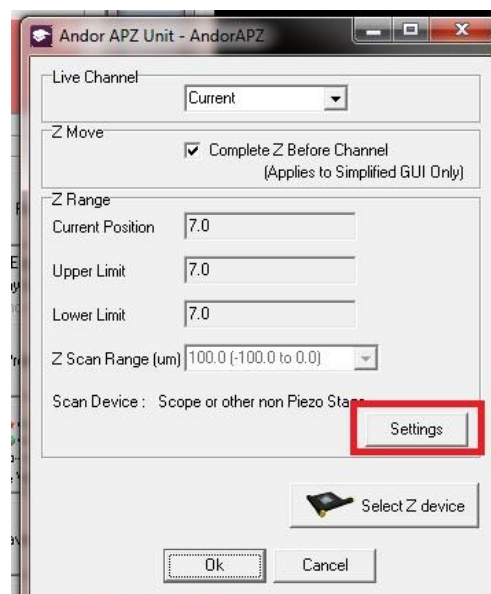

Working Distance

The wizard is used to determine how far and in which direction the sample will move. Once the working range is defined the GUI will provide better feedback on the current stage position and allow easier control when using the mouse wheel or and scroll bar.

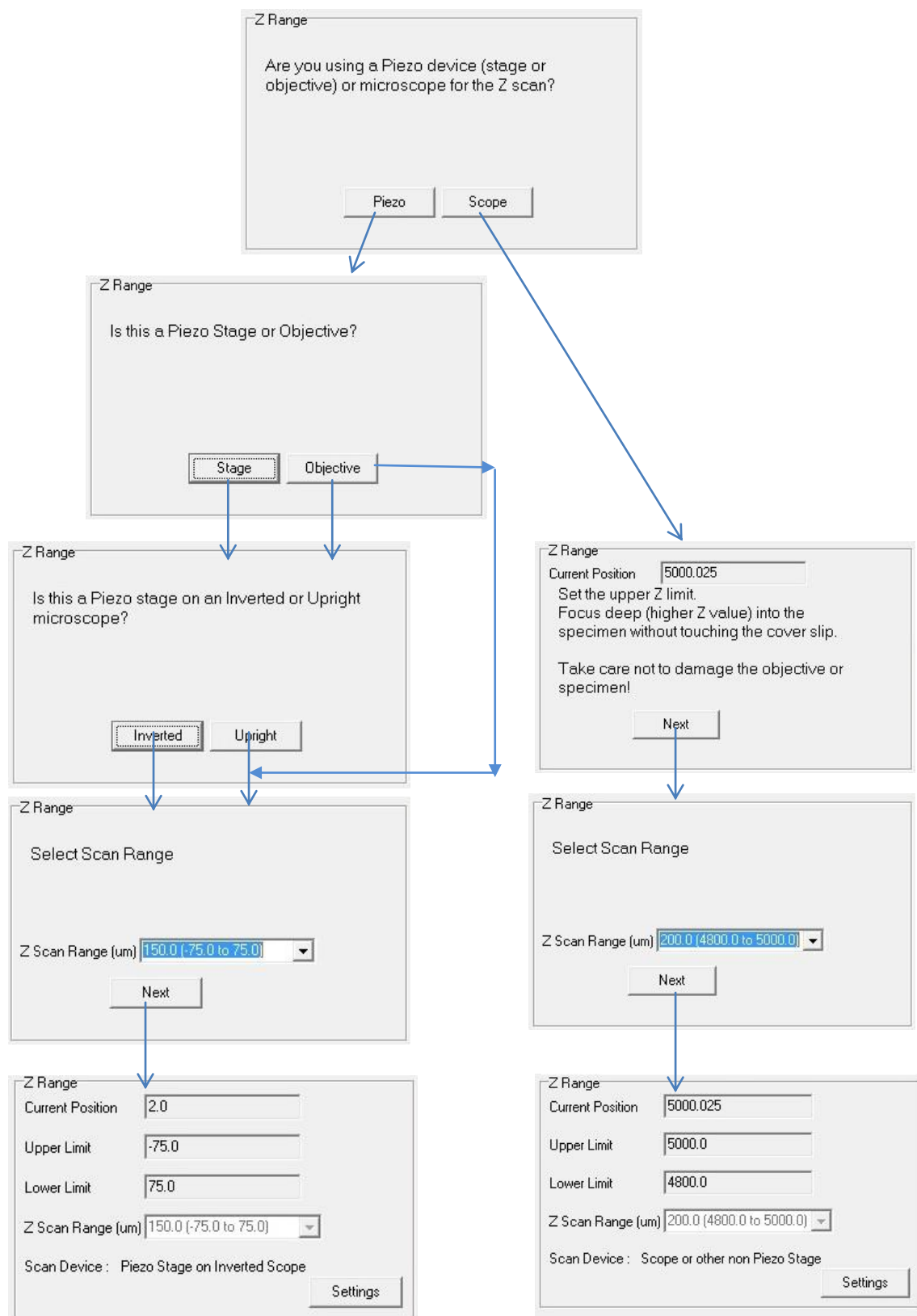

Piezo

Scope

The Z panel workflow is from left to right as follows.

Z scan modes

There are 3 modes of operation

1. Start/End
2. Centre
3. Start

Simply toggle the selection button to change the mode.

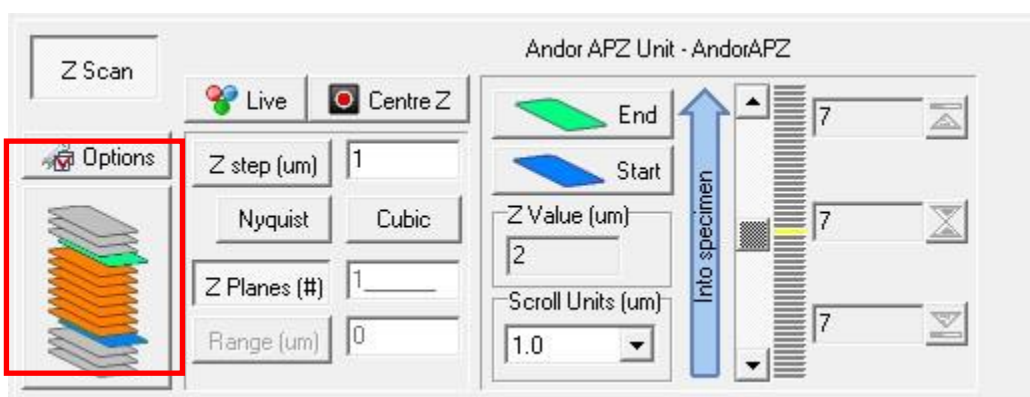

Step/Planes/Range

Live will also activate the channel specified in the Z scan option panel.

Centre Z allows easy movement to the centre of the working range.

The **Step**, **Planes** and **Range** buttons specifies which parameter will be calculated (depressed). You can enter values for the other parameters in the edit boxes.

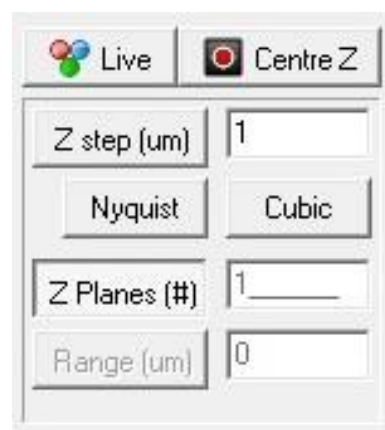

Nyquist and **Cubic** buttons offer a convenient way to calculate the Z step for the selected calibration.

Z control and scan selection

Start, **End** and **Centre** buttons allow the current position to be recorded into the scan. The buttons will change to match the current mode.

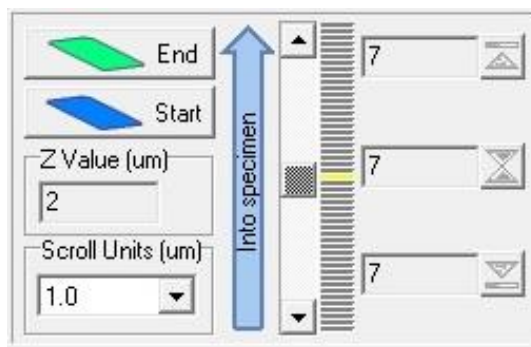

Z Value shows the current Z position.

Scroll Units sets the sensitivity of the scroll bar. Scroll bar and mouse wheel are used to adjust Z.

Status Indicator shows the current position and current selection. The colours will be explained below.

Start, **Mid** and **End** indicators show the selected Z scan range, the associated buttons offer a convenient way to navigate to each. These will enable as the positions are defined.

Start/End Mode

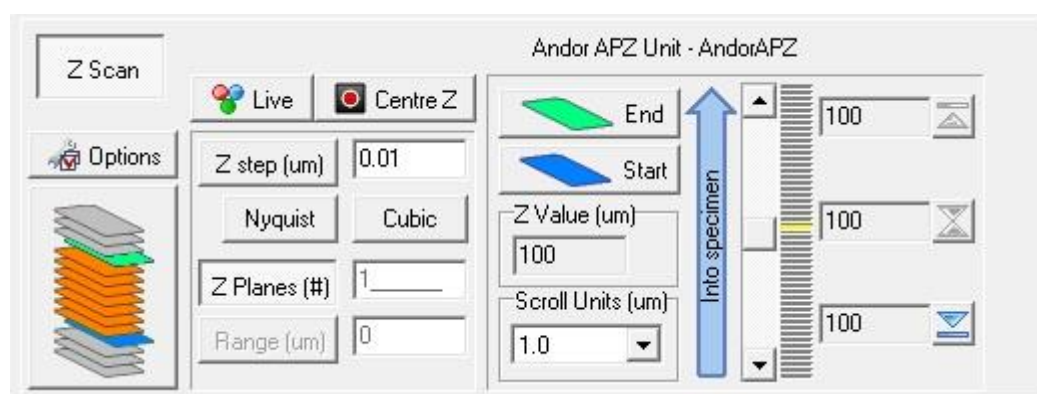

Yellow indicator shows current position, no scan is defined

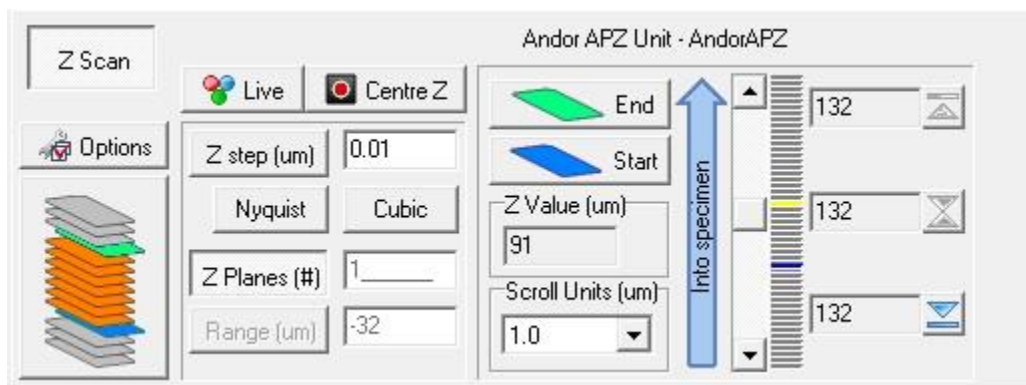

Blue indicator shows recorded Start position

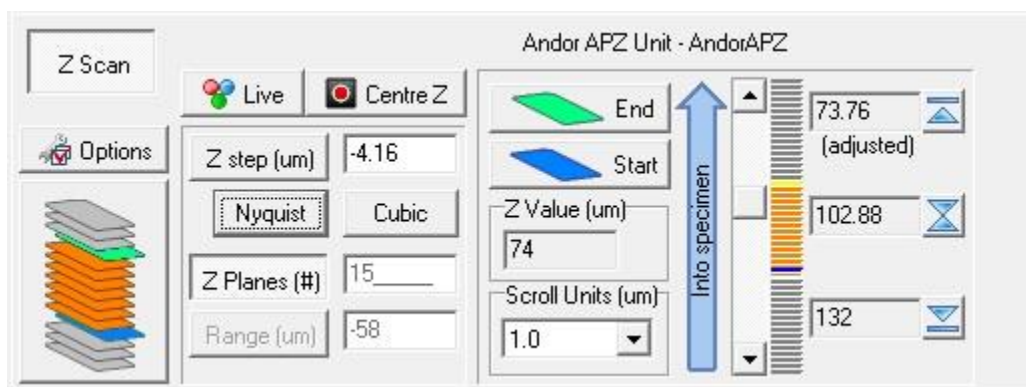

End position is defined.

Orange area shows scan range,

End position will highlight in green,

Current position will highlight in yellow.

Centre

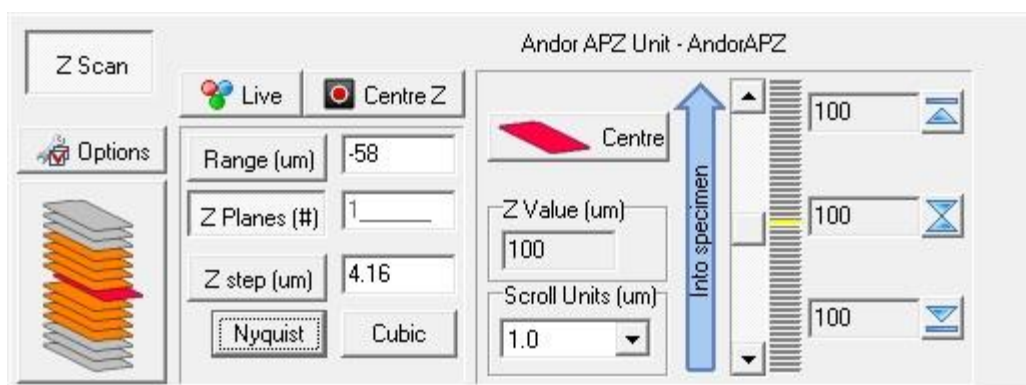

Yellow indicator shows current position, no scan is defined

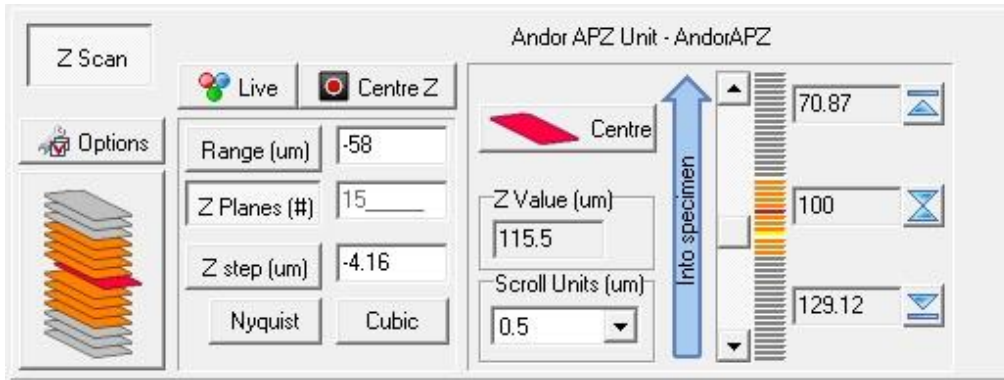

- Centre position is defined.
- Orange area shows scan range.
- Centre position will highlight in red.
- Current position will highlight in yellow.

Start

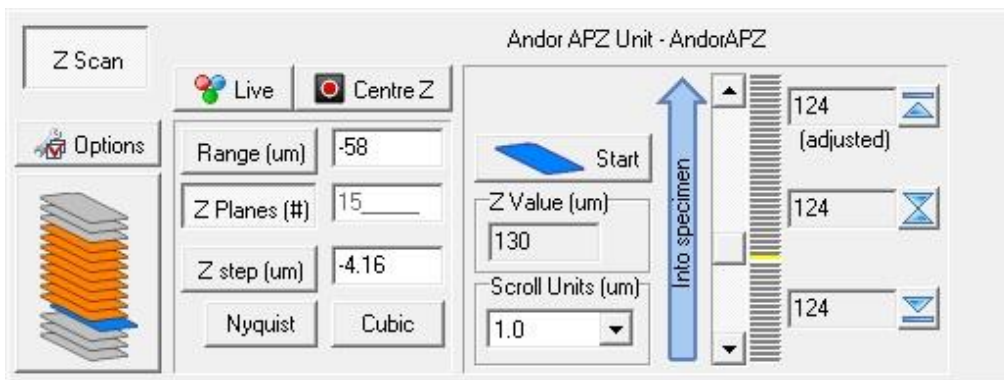

Yellow indicator shows current position, no scan is defined

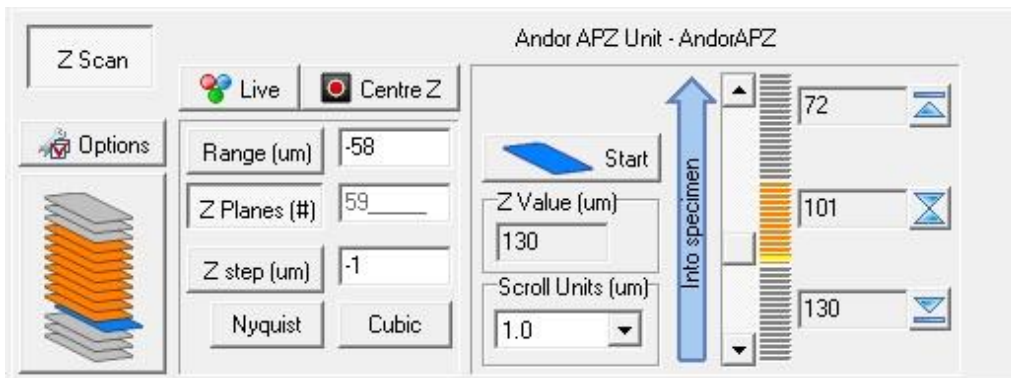

- Start position is defined.
- Orange area shows scan range.
- Start position will highlight in blue.
- Current position will highlight in yellow.

4.3.3 Multi-Field Scan

Multi-field Scan definition is the simplest because the system requires no knowledge of stage axes alignment or orientation. Multi-well and Montage need that information so that iQ can interpret well-plate layout and stitch fields together. In multi-field scanning you simply record a series of XY positions to be revisited when the Protocol executes.

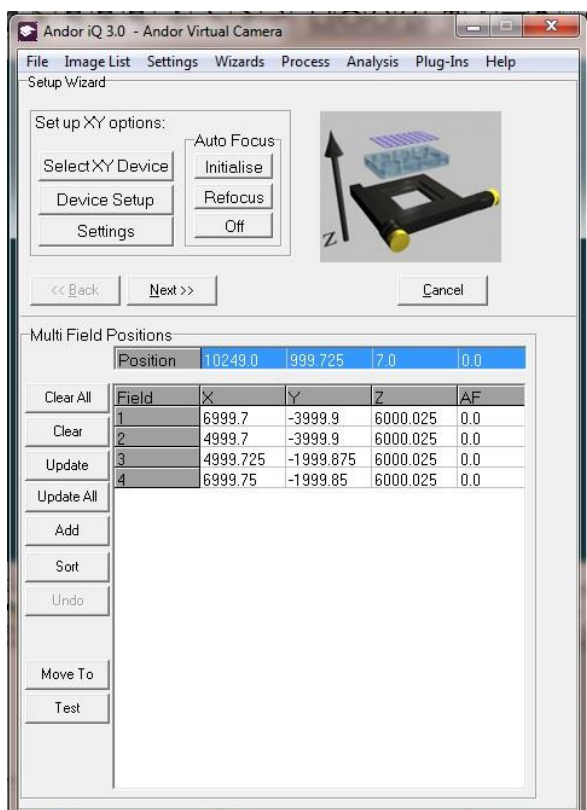

Only a summary of the field recording dialogs will be shown here. Choose Multi-field from the Scan Manager and press **Next**.

Using the joystick, move the XY stage to the position of the first field. The x and y positions will update in the blue highlighted text boxes (as will the z position if you have a Z motor).

Click **Add** or **Update** to record the field. Repeat to specify the positions of each field.

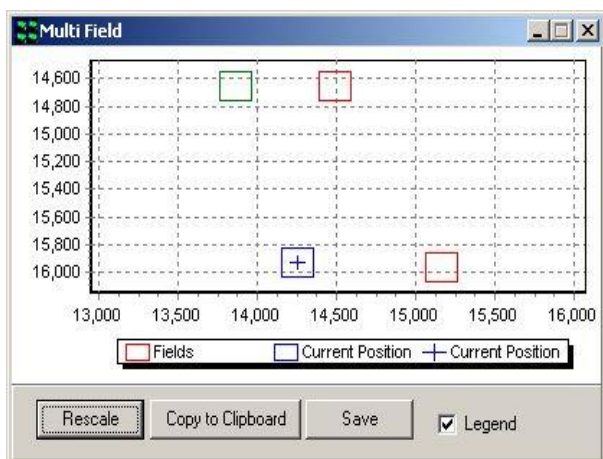

During the field definition iQ will show a graphical view of the current stage position (+) and the fields selected so far as shown left – in this case 4 fields have been defined and you can see their relative positions in stage coordinates (1000 um – 1mm).

This graphic will update whenever you run or change the scan in a Protocol.

Note: When editing a multi-field scan iQ will allow you to choose to **reposition the Z stage at the XY fields listed in the scan**. This is essential if you are reviewing fields in a scan. You can also choose whether to allow iQ to re-use previous focus or Z positions during repositioning. We make this an option to reduce the risk of resetting incorrect focus positions which may damage the objectives. To enable Z movement click the **Settings** button.

Autofocus – when you want to record and Autofocus setting at each field, make sure that you have the Device Setup dialog visible and the microscope tab selected. Then initialize the Autofocus button in the interface. iQ should indicate if the Autofocus was successful. When you click Add or Update, iQ will record the current Autofocus setting from the microscope.

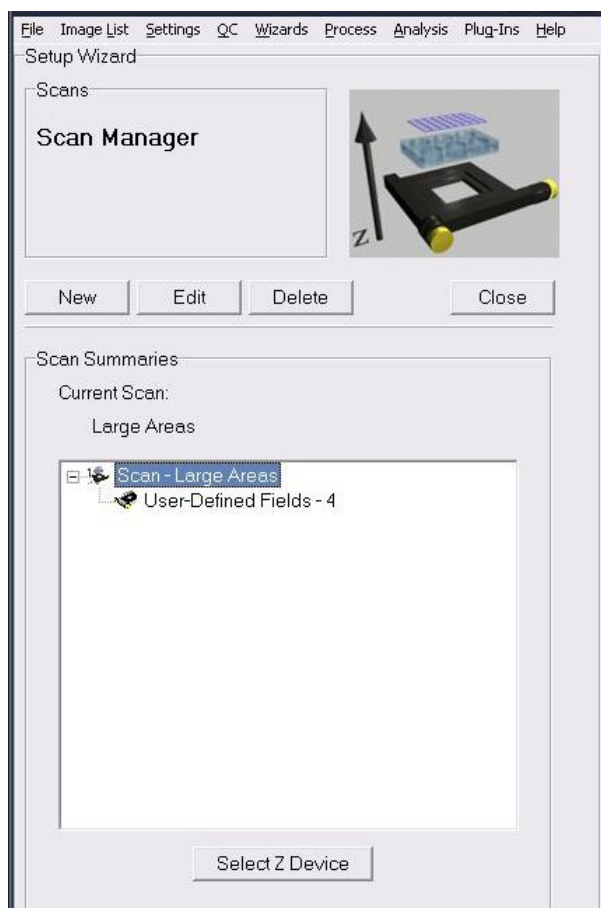

Press **Next** to return to the Scan Manager, where the new scan has been added to the list.

Clicking on the plus sign to the left of the scan name displays summary information for the selected scan file.

4.3.4 Multi-well or Micro-plate Scan



To start Multi-well definition, select the appropriate radio button in the Scan Manager. Then choose whether you want Systematic Sampling (computer chosen) or User-defined fields to be imaged in the wells. This will be explained later.

Note: BEFORE you define a multi-well pattern or montage scan, you MUST successfully run the Stage Alignment Wizard.

Press Next to proceed to the next step.

Select **Create new well pattern**, then press **Next** to continue.

Note: If you have previously created a well pattern you can **Use existing well pattern**, or **Edit existing well pattern** to modify its parameters).

If you want to apply the same Well pattern, but for a different experiment, then use Edit.

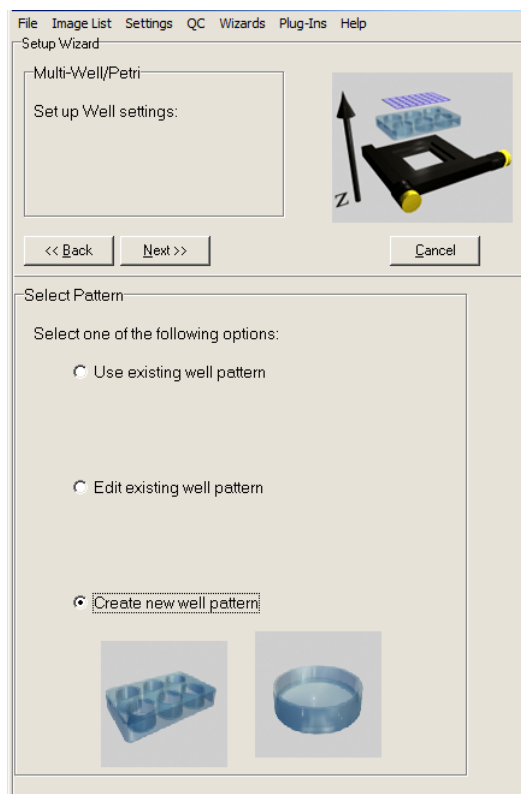

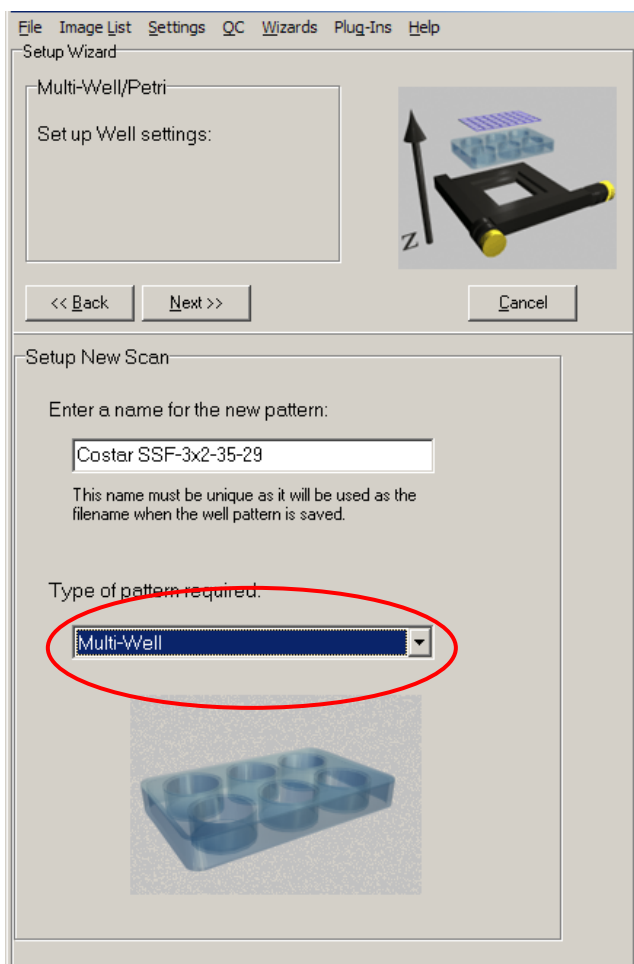

From the dropdown list box on the dialog (red highlight) select the type of scan required:

Enter a unique name for the scan pattern into the text box. Scan patterns will be available to all users, so it is therefore important to have a clear naming convention that describes the scan setup. In this example we have named the scan pattern:

Costar-ssf-3x2-35-39

Costar	Model of the micro plate
ssf	Type of scan (systematically sampled fields)
3x2	Number of columns and rows of wells
35	Well diameter (in mm)
39	Well separation (In mm)

Press **Next** to continue.

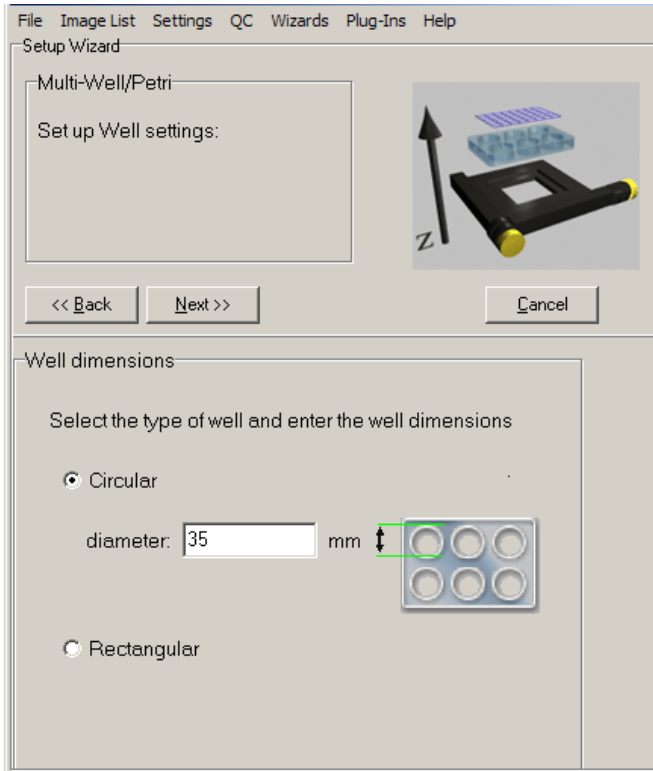

Select whether you are using a circular or rectangular well. If **Circular**, enter the well diameter in mm into the text box. If **Rectangular**, enter the well height and width.

Press **Next** to continue

Enter into the text boxes the number of columns and rows of wells.

For the Well Separation, enter the distance in mm from the start of one row to the start of the next, and from the start of one column to the next.

Press **Next** to continue.

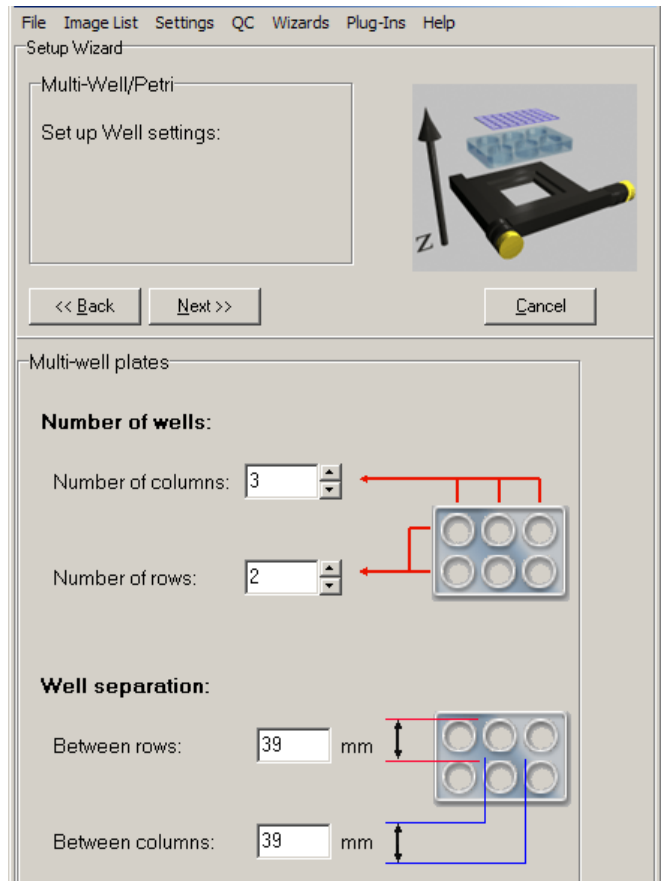

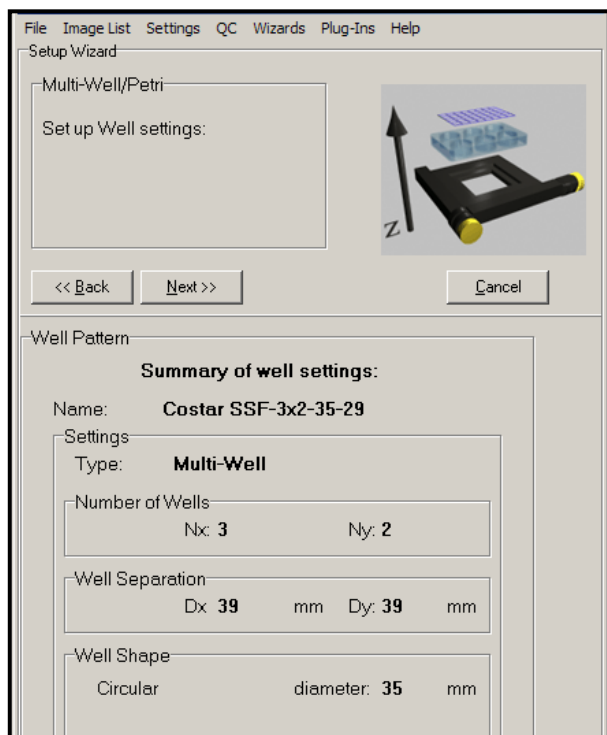

A summary of the well settings is now displayed.

Press **Next** to continue.

Once the Well or plate pattern has been defined (or selected if you are re-using or editing the pattern) then the user needs to show the system the top and left edges of the first and second wells of the first row of the pattern. This is needed to allow iQ to

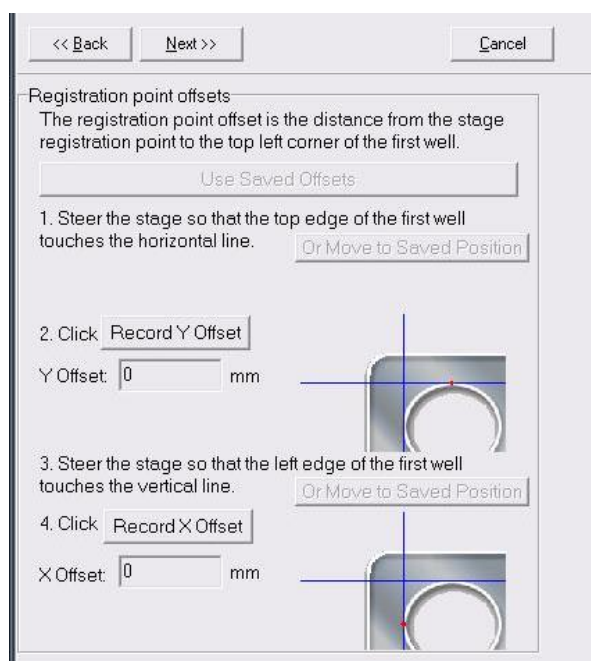

deal with pattern **Skew i.e. rotational offset** relative to the camera and stage coordinates. This can occur in various scenarios when a pattern is fixed manually to a carrier or substrate and is not perfectly aligned.

There are two dialogs to handle this. This first dialog asks to define the first well edges as shown in this dialog on the left. Click on the Record Y offset and X offset buttons at the relevant time.

The second skew dialog, shown below, requires the user to define the top and left edges of the second well. The system will move to its estimate of the top left of the second well if you click on the “Move to Second Position” button, to help the user

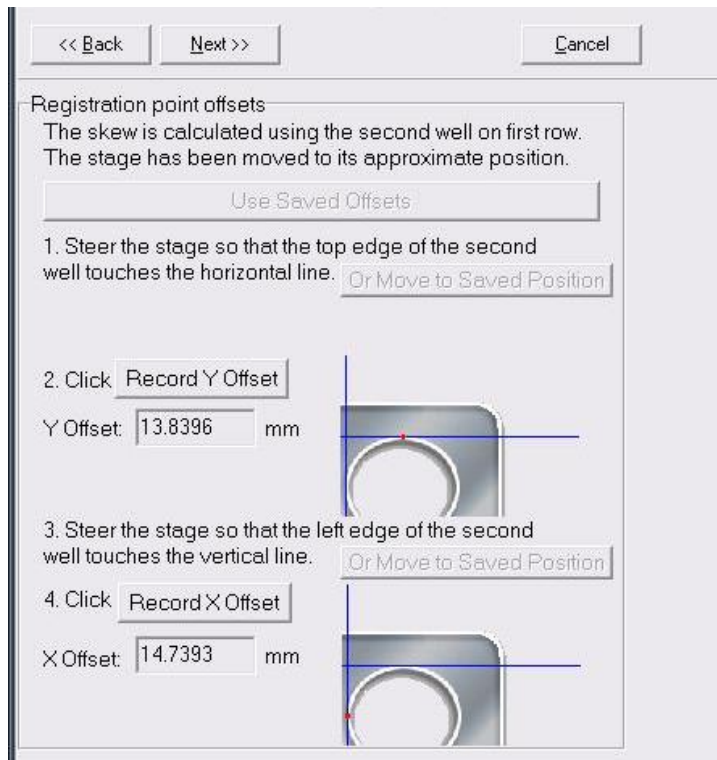

with a starting position. When you have identified the top edge click on the Record Y Offset button and the left edge click on the Record X Offset button. The system will now compute the **Skew** or Rotational offset for all wells in the pattern and apply this to the well coordinates.



The **Rejection/Inclusion List** panel is shown next and here you can define which wells should be included in the Scan pattern. This allows you to define a list of wells which either have not been used or contain no viable specimens. The list is created by typing the numbers of the wells or ranges and you can choose whether this is the Rejection or Inclusion list with the radio button.

In the next stage you will define the fields to be imaged in each of the wells. Two options exist: one for Systematic Sampling and the other for User-defined fields.

4.3.4.1 Systematically-Sampled Fields:

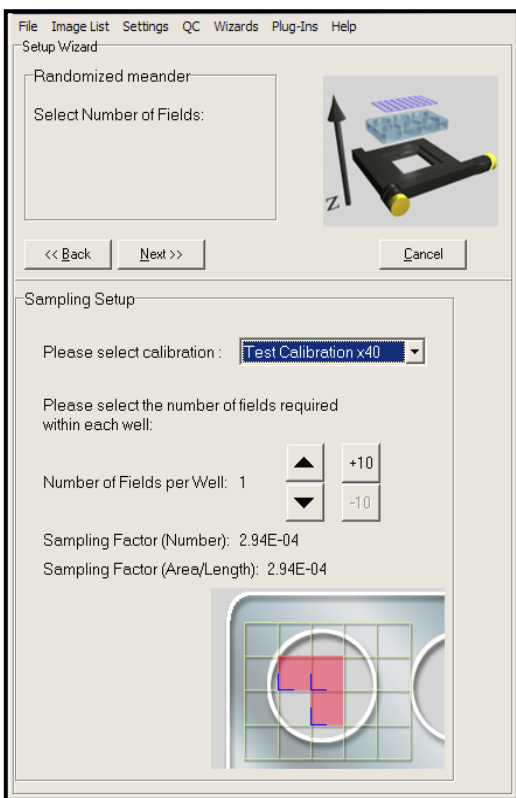

From the Calibration dropdown, select the XY Calibration that you will use for the acquisition and ensure that the correct objective is selected.

Specify the number of fields to sample within each well. The arrows change the value by 1; the +/-10 buttons change the value by 10.

A uniform random grid will be “thrown” into specimen space, in which the X and Y repetitions are at a uniform distance and the grid is positioned so that the specified number of fields lies within the well.

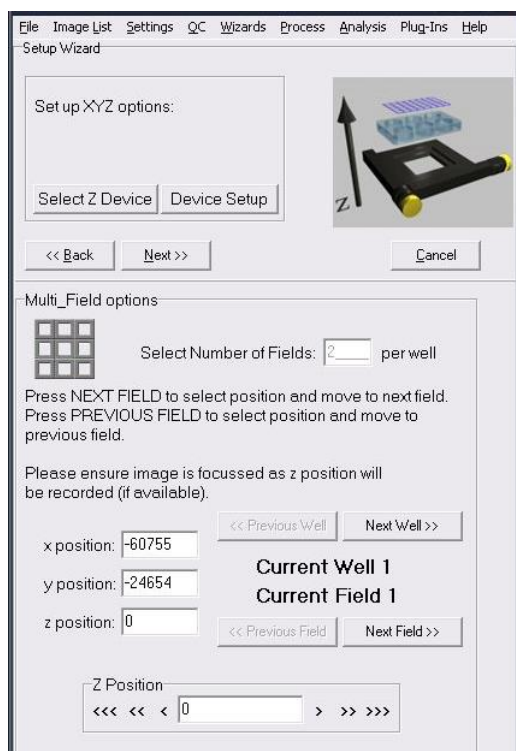

The following step allows you to review the position of the computed fields and modify them at will.

Note: Autofocus – when you want to record and Autofocus setting at each field, make sure that you have the Device Setup dialog visible and the microscope tab selected. Then initialize the Autofocus button in the microscope interface. iQ should indicate if the Autofocus was successful. When you click Next Field or Next Well, iQ will record the current Autofocus setting from the microscope.

4.3.4.2 User-Defined Fields:

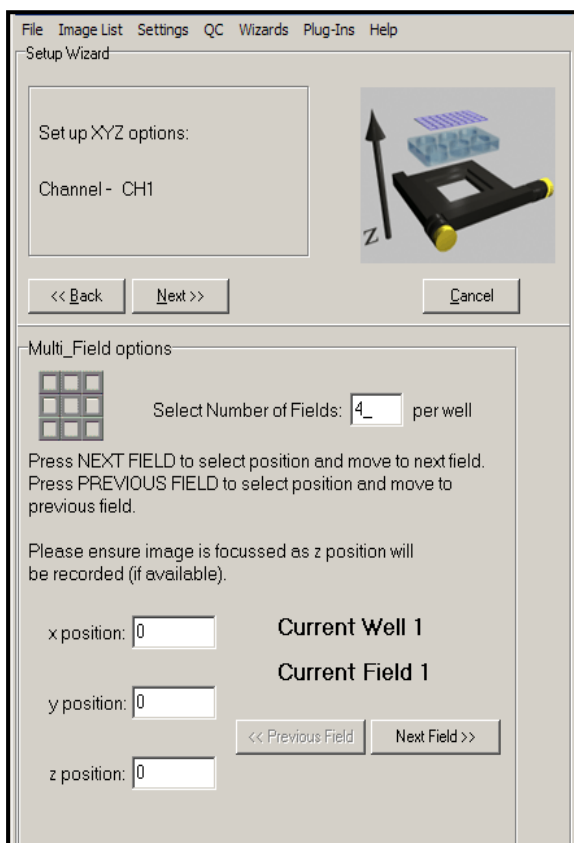

The stage will move to the top left quadrant of the first well. Enter the number of fields for each well.

Using the joystick, move the XY stage to the position of the first field in the first well. The X and Y positions will update in the text boxes (as will the Z position if you have a Z motor).

Press **Next Field**, and then repeat the above to specify the positions of each field for all wells.

At the start of each well, the stage will automatically move to the top left quadrant of that well.

When you enter the field definition phase the **scan graphic** will show the well pattern and the fields within the wells as shown on the right. This example shows a **24 well plate with systematic sampling, density 5 fields per well**. Note that wells 9,10,15 and 16 have been **Rejected**. The **First** well is shown at top left and identified as **blue**, while remaining wells are green.

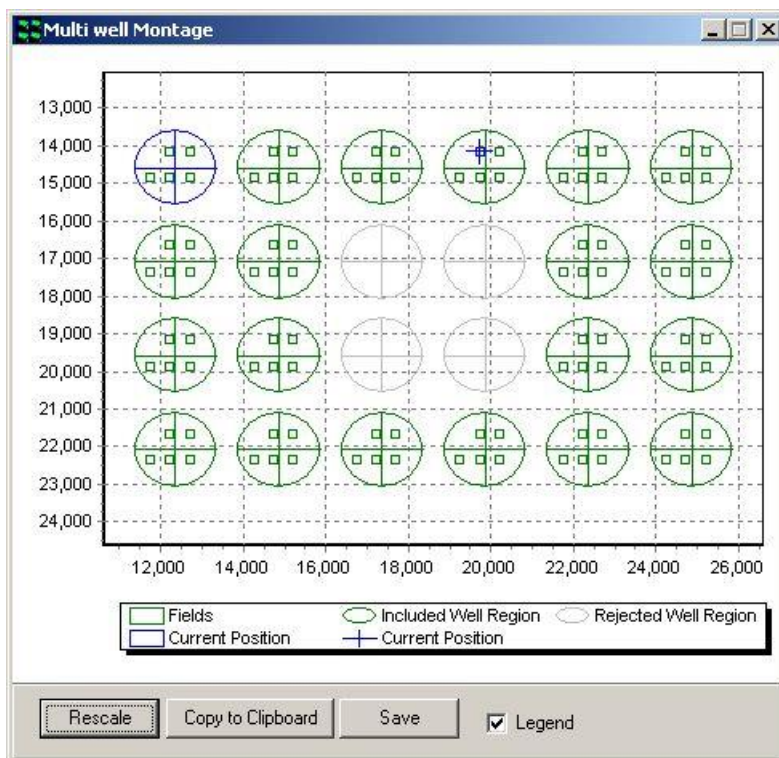

Note: Autofocus – when you want to record and Autofocus setting at each field, make sure that you have the Device Setup dialog visible and the microscope tab selected. Then click on the **Initialize the Autofocus** button in the GUI for each field

required. iQ should indicate if the Autofocus was successful. When you click **Next Field or Next Well**, iQ will record the Autofocus setting from the microscope.

Press **Next** at the top of the field definition dialog to continue.

You will now return to the Scan Manager, where the new scan has been added to the list. Clicking on the plus sign to the left of the scan name displays summary information about the scan.

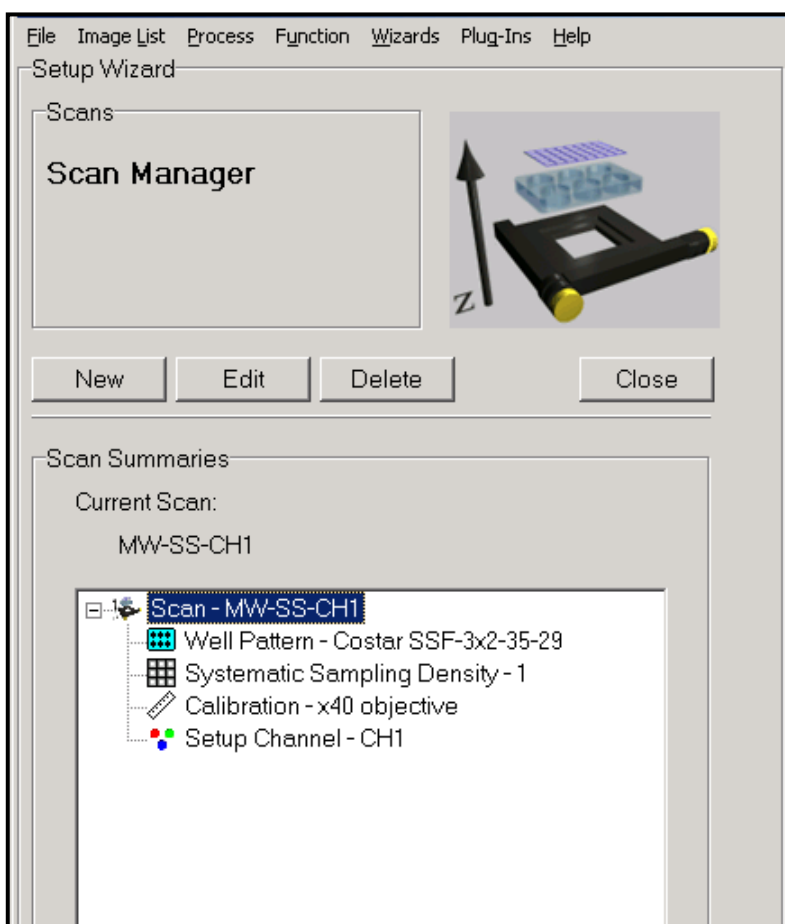

4.3.5 Montage scans

Montage uses a motorized XY stage and collects neighboring images to construct a field of view larger than the camera sensor.

We can use Montage scanning in either a single scan definition or as part of a multi-field or multi-well scan. In the multi-field and multi-well cases, montage is constrained to be a rectangular region, specified in mm or fields, centered on each field of those scans. The montage fields are automatically included with each field when you select Montage with Multi-Field or Multi-well in the Scan Manager. You choose how large the montage at each field will be.

Setup steps before Montage scanning is possible:

1) Always select an accurate objective calibration.

Typically the automatic calibration is not sufficiently accurate to move the XY stage the correct distance. If you do not have a calibration created by manually imaging a reticule slide, run an interactive calibration with the objective and camera combination you wish to use for Montage as follows:

Protocol Menu > Wizards > Calibration > New > Interactive

Before proceeding you must have your newly created calibration selected via the objective icon in the protocol window.

Please see **Section 3.2** for further details.

2) Run the Stage Registration Wizard once.

XY stages have movable limit switches. Thus the software needs to find where the stage origin (0, 0) exists by moving the home position. By default the software requested to do this on startup. If you cancelled this process or did not see the

screen (i.e. the checkbox to not prompt for Stage Registration is enabled), invoke this wizard from:

Protocol Menu > Wizards > Stage Registration Wizard

Please see **Section 3.2** for further details.

3) Run the Stage Alignment Wizard once.

This wizard tells the software how the XY axes of the camera match the XY axes of the stage. Run this as follows:

Protocol Menu > Wizards > Stage Alignment Wizard

Please refer to **Section 3.5** for further details on the Stage Alignment process.

Note:

- The current state of your Andor camera image flip and rotation are applied to the Wizard (non-Andor cameras do not have these settings in iQ). If you change these properties of the camera or change your stage XY behavior this step is invalidated and you have to run the Stage Alignment Wizard again. Before proceeding make sure the camera rotation and XY stage joystick movement is to your liking.
- The camera flip and rotation properties are stored on a per Protocol basis. If you have Montage working in one Protocol, it will not work in another Protocol if the camera flip and rotation differ. Although objective calibrations are shared between all configurations, these camera properties are not.

4.3.5.1 Linear Montage Scan

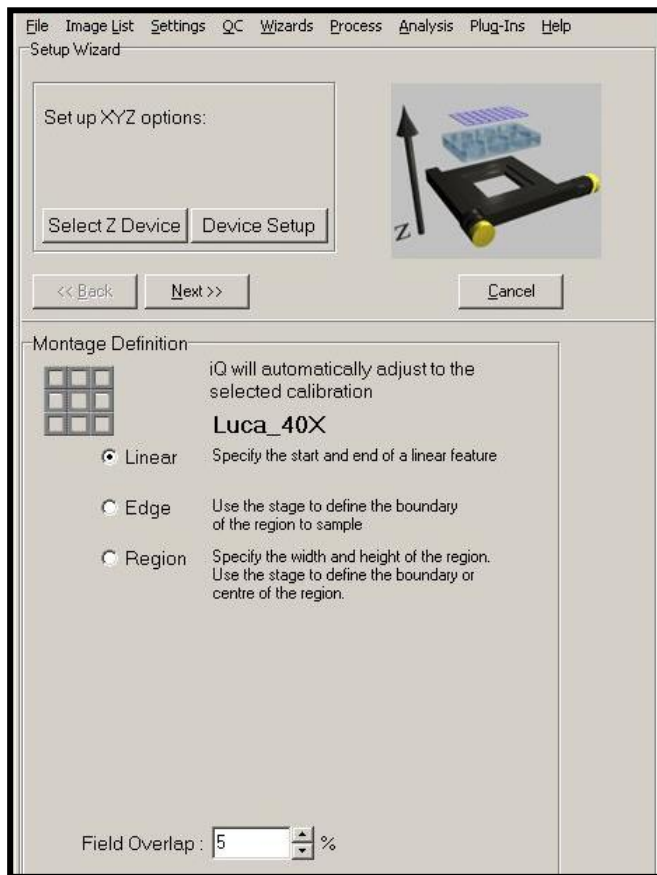

The **Linear** method is designed to support observation of filamentous structures, vessels or regions of feature boundaries. We show some examples of vessels from H+E stained brain sections later in this chapter. Other users are exploiting this technique for applications including imaging of “combed” DNA.

Select **Linear** and then click **Next**.

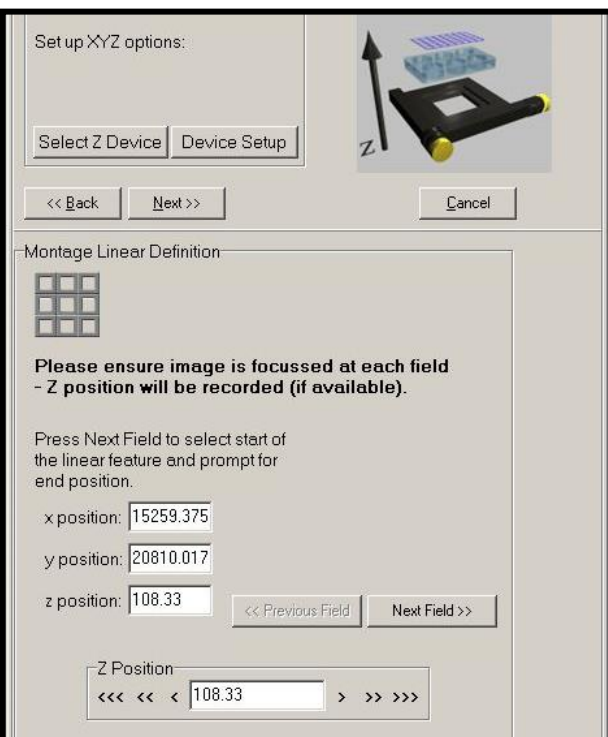

Now move the stage with the joystick and choose start and end fields defining the line to be scanned. You should ensure that you focus each field - iQ will interpolate the Z values for the intermediate fields. Click on **Next Field** when you have specified the start and want to the end field.

Click on **Finish** to select the last field and terminate the Wizard.

4.3.5.2 Region and Edge Montage Scan



The **Region and Edge** montage scan definition wizards result in a rectangular set of fields to produce an image of a feature that exceeds a single Field of View. In the **Region** case you can specify the area to scan in Fields or in millimeters as shown below. While in the **Edge** mode, you specify fields that are at the edge or boundary of the feature you want to image and iQ computes the enclosing rectangle for scanning and defines fields automatically.

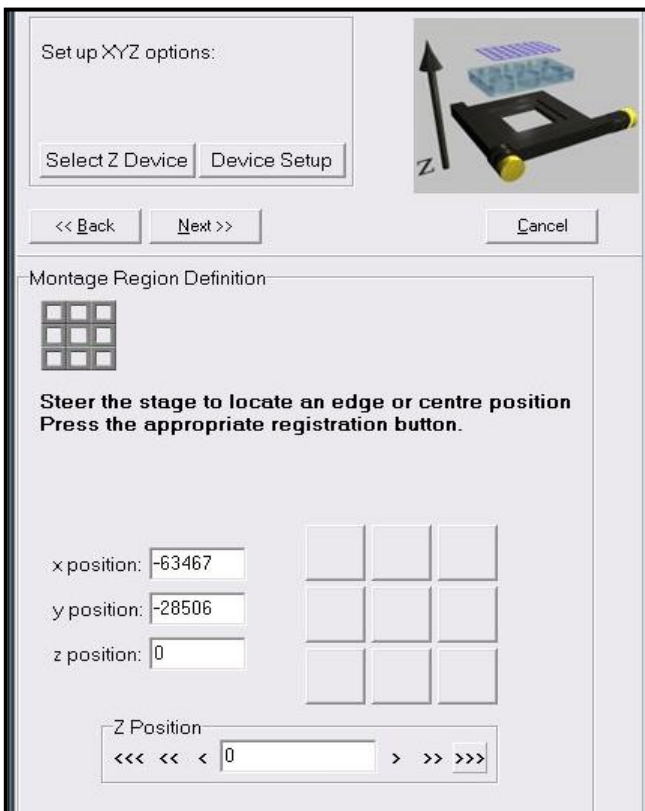

In **Region** mode you define the size of the region at the first step and then with the wizard panel shown here, you can adjust the stage and when you click on one of the 9 (3x3) buttons you specify the current field of view to be at that location within the Montage. E.g. if you click to top right button the field becomes the top right field of the Montage and if you click the center button then it becomes the central field and so on.

When you define the Montage scan, the stage graphic will be shown as below to provide a context and visual feedback.

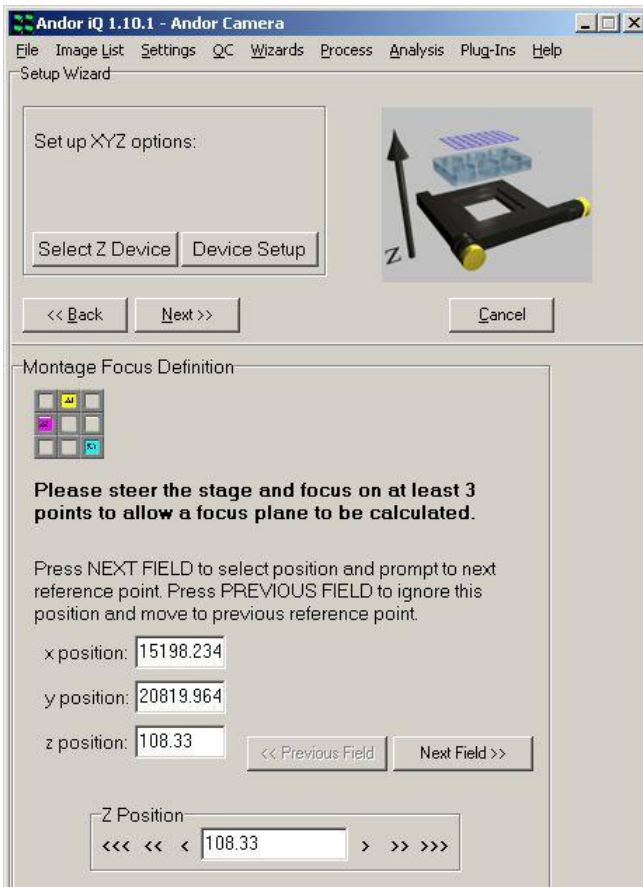
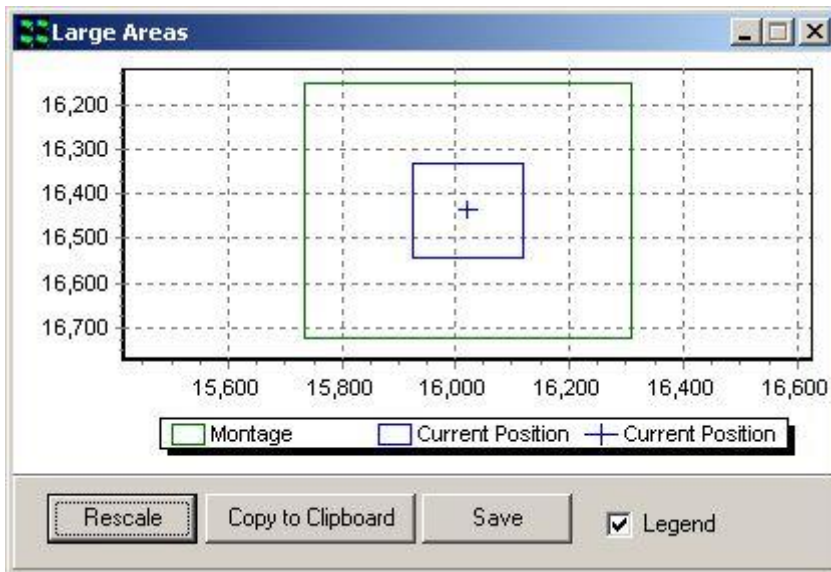

In both **Edge** and **Region** cases you can give iQ some help with focus control and it will fit a best approximation focus plane to try to keep the feature in focus throughout the scan.

To make use of this feature use the joystick to move to some fields within your scan and focus the feature of interest and click on **Next Field**. You will need to specify focus for at least 3 positions to allow fitting of a focus plane.

If you want to ignore the focus plane tool, then simply Click on **Next** at the top of the wizard panel. Then iQ will

use the field values you specified.

Andor iQ USER GUIDE

You can use the microscope hardware Autofocus to compensate for drift and in that case, iQ should apply the focus plane taking into account the drift-corrected Z values.

In all cases you can add a Z scan (in Time Lapse) or utilize FLZ to ensure that you have sufficient Z range to obtain a focus image across the entire feature.

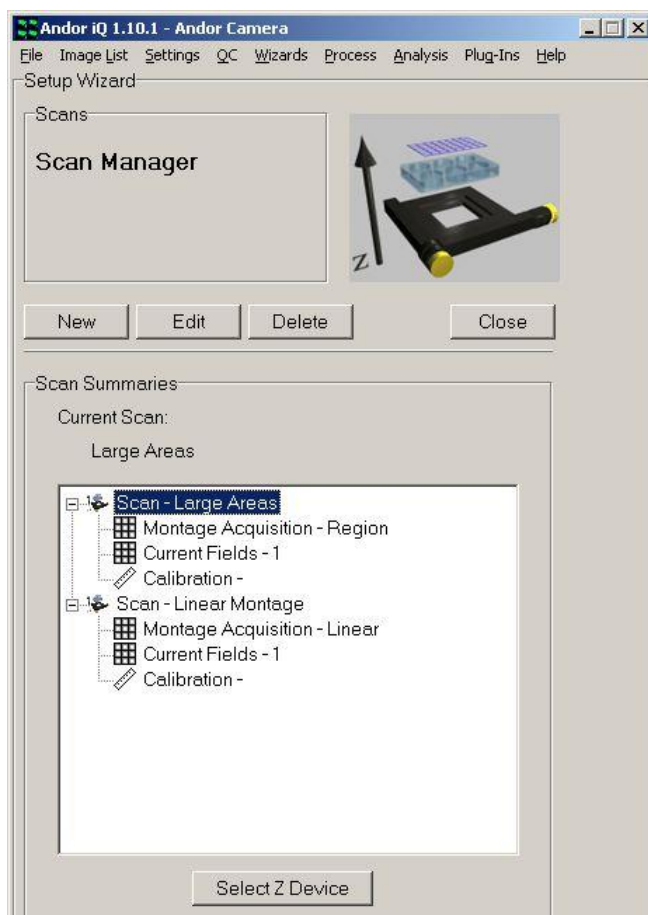

When you have finished creating or editing your scans they will appear in the Scan Manager list of scans, clearly identified as Montage scans as shown here.

4.3.5.3 Montage Scan Review and Visualization

When iQ executes a Protocol with a Montage scan within it, it will acquire the data and organize into a logical n-dimensional structure, which can be navigated in the Image Window.

The Montage dimension specifies the individual fields within the montage. An example is shown in the first image on the next page.

If the Montage is associated with a multi-field scan, then there will be a Field dimension and a Montage dimension.

Andor iQ USER GUIDE

If the Montage is associated with a multi-well, multi-field scan then there will be Well, Field and Montage dimensions.

Montage scanned images have a Montage dimension in the Navigator as shown above, which allows exploration of the individual tiles or fields.

To create a stitched or tiled view of the fields you can use iQ's Montage Plugin which is accessed form the View menu in the Image Window.

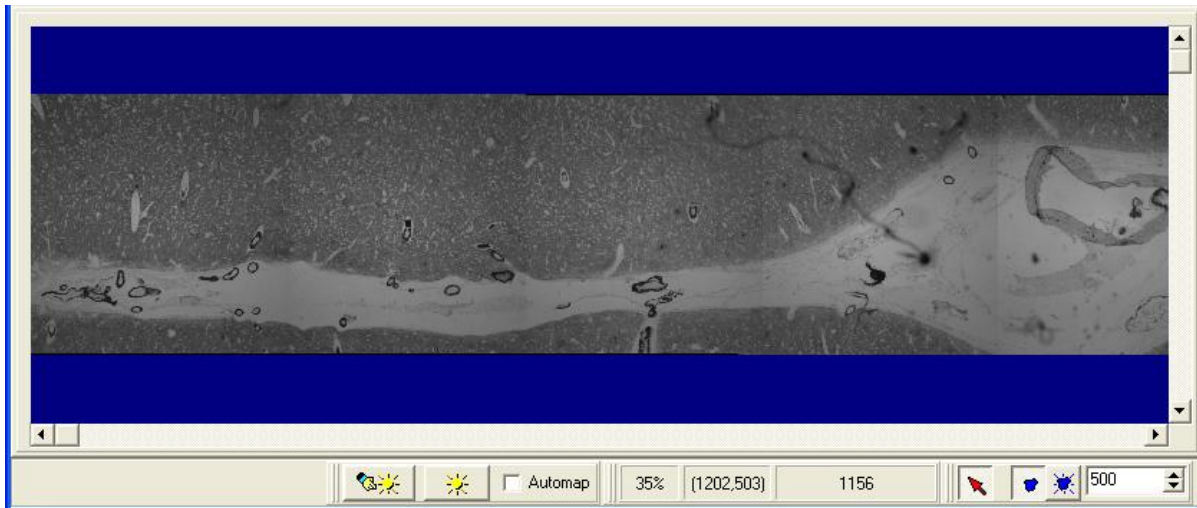

The image above shows a blood vessel in a brain slice and was acquired with a Linear Montage in iQ.



This example shows the result of stitching a diagonal Linear Montage scan.

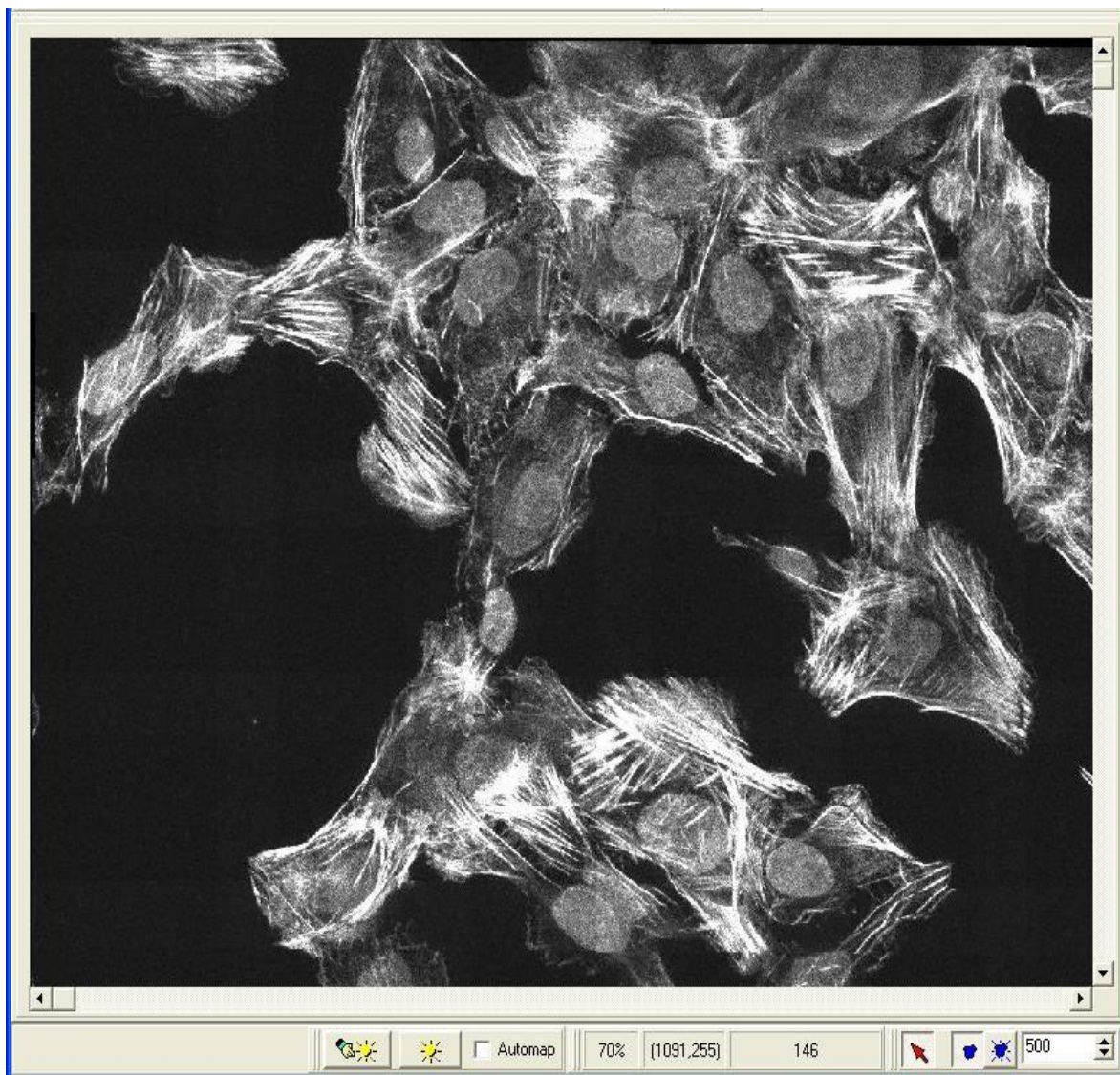

A Montage reconstruction is shown above from one well of a micro-plate. We see cell nuclei (labeled with Hoechst) and F-actin associated with focal adhesion protein Talin (labeled with Rhodamine-phalloidin). Image supplied courtesy John Locke, Karolinska Institute, Sweden.

4.3.6 Inserting Scans into nD Protocol Trees

Once you have created XY Scans it is an easy matter to include them into a Protocol.

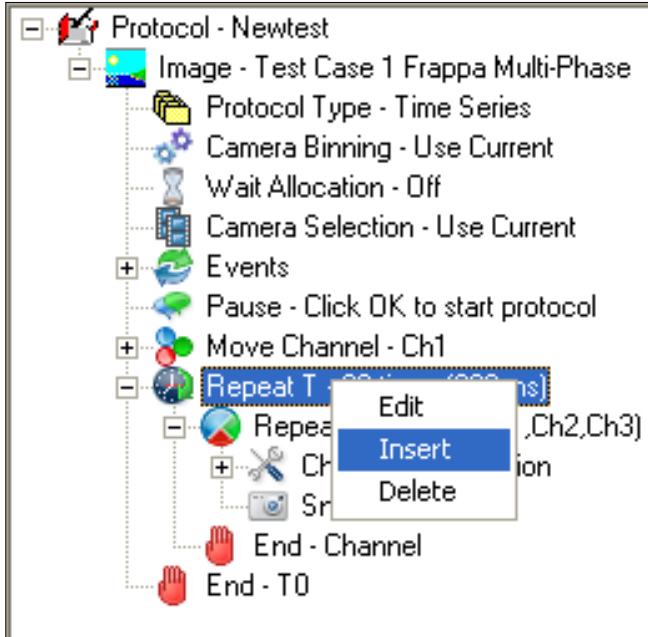

In this example a multi-channel time-lapse protocol is shown with 3 channels.

To add a scan into this nD Protocol Tree select the Repeat T keyword in the Tree and then click the right mouse button and a pop-up menu appears - choose Insert.

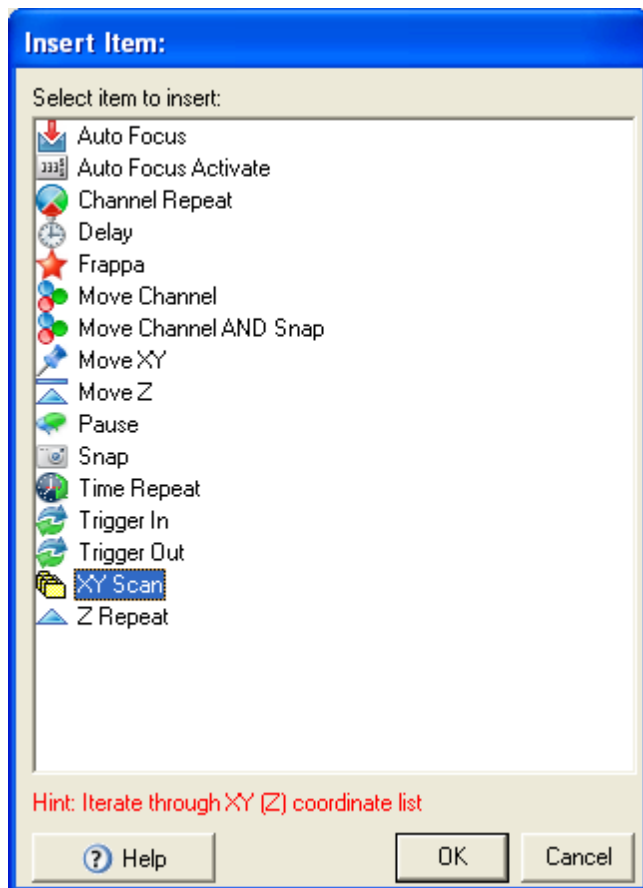

The Insert Item dialog shown on the left appears and you choose an Action - XY Scan in this case.

Next the Select Scan panel appears as shown over the page.

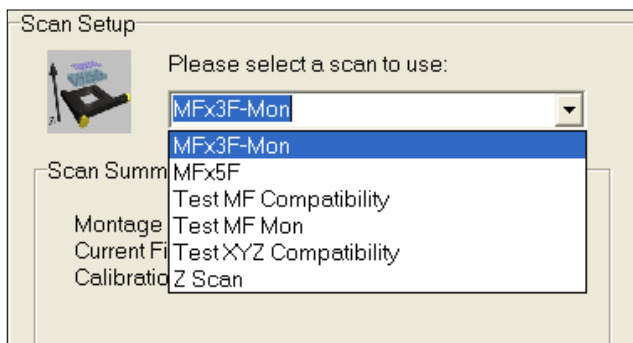

You can then select a Scan from the drop down list box – in this case a 8 position XY scan was chosen.

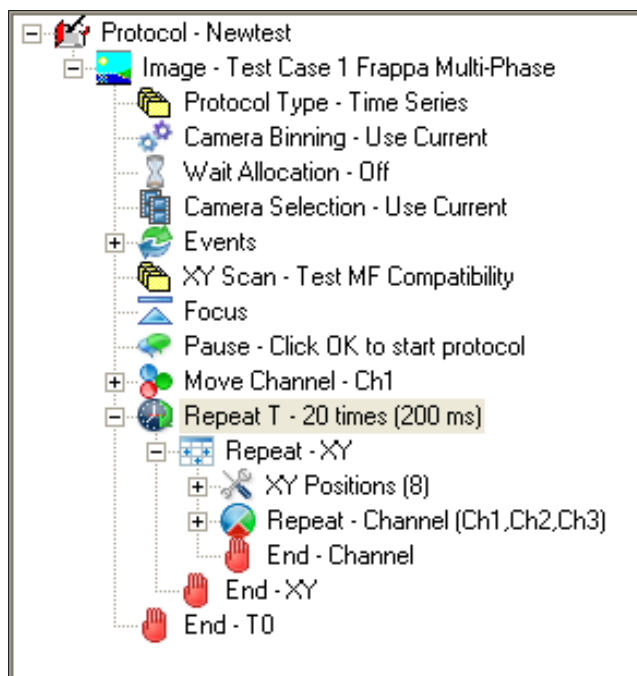

After you click on Next the Scan will be inserted into the nD Protocol Tree as shown on the left.

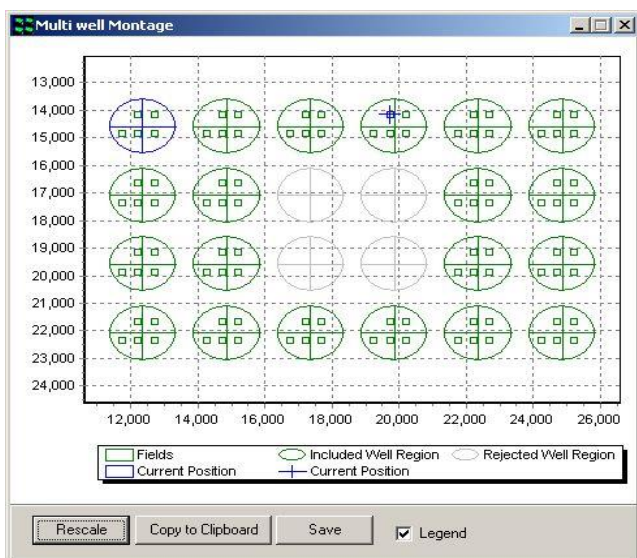

Note: when you Insert the scan into the Tree, iQ will either update or initialize the scan graphic with the well pattern (if applicable) and the fields to be scanned as shown here.

4.3.7 Adjusting Scan coordinates using the nD Protocol Tree

Scan coordinates can be adjusted easily using the Protocol Tree. It is not necessary to resort to the Scan Wizard to modify an existing scan pattern; scan coordinates can be modified by a click of the mouse.

4.3.7.1 Modifying a Multi-Well Scan

The nD Protocol Tree corresponding to a Multi-well scan experiment is illustrated below.

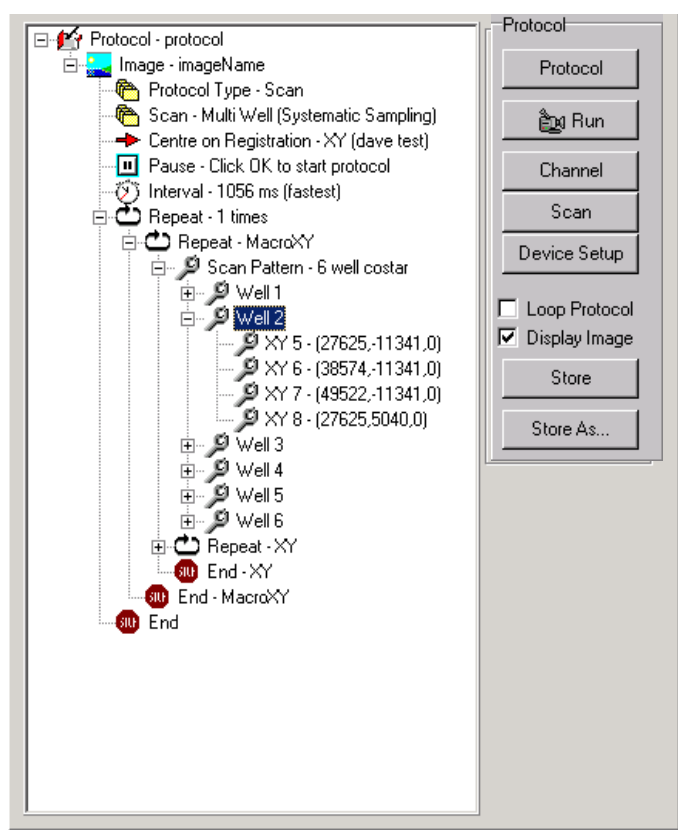

The details of the scan pattern are disclosed by clicking on the + symbol adjacent to each item in the nD Protocol Tree using the left mouse button.

The example scan illustrated comprises 4 XYZ locations for each well in a 6 well plate.

The individual XYZ scan positions are displayed for the second well.

Expanding the nD Protocol Tree and clicking on the appropriate XYZ position using the left mouse button can select any set of coordinates in the scan pattern. An example is shown below for the scan coordinates XYZ 5 in the second well.

Clicking on the highlighted coordinate set with the right mouse button displays a pop up with two commands **Move To** and **Record Current**.

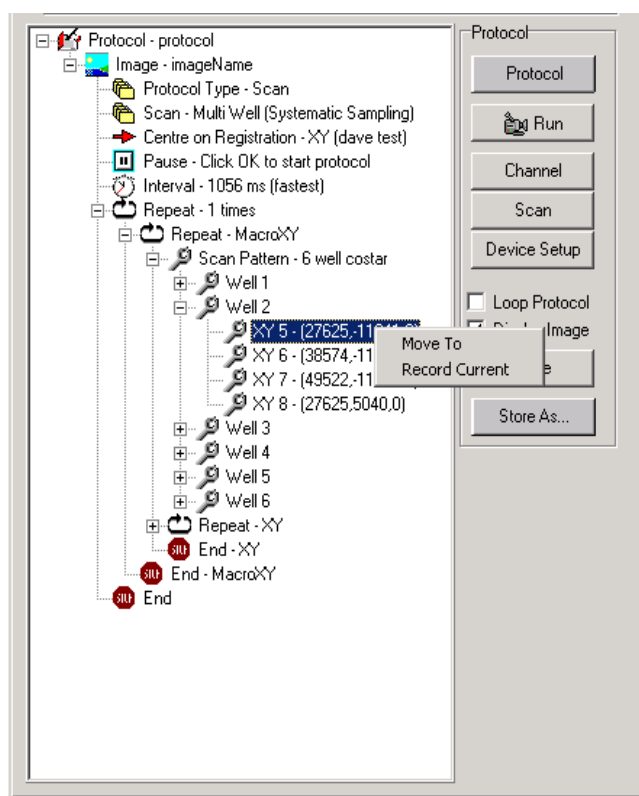

By moving the stage and clicking on the **Record Current** option using the left mouse button, the current coordinate position is updated in the list and permanently recorded with the scan.

Highlighting a coordinate set and selecting the **Move To** option moves the stage to the coordinate positions listed.

4.3.7.2 Modifying a Multi-Field Scan

An expanded nD Protocol Tree corresponding to a Multi-field scan experiment is illustrated below.

The XYZ coordinates for each location in the six-position scan are displayed in the tree. Selecting the coordinate of interest and clicking the right mouse button accesses the Move To and Record Current commands as described previously in **Section 4.3.7.1**.

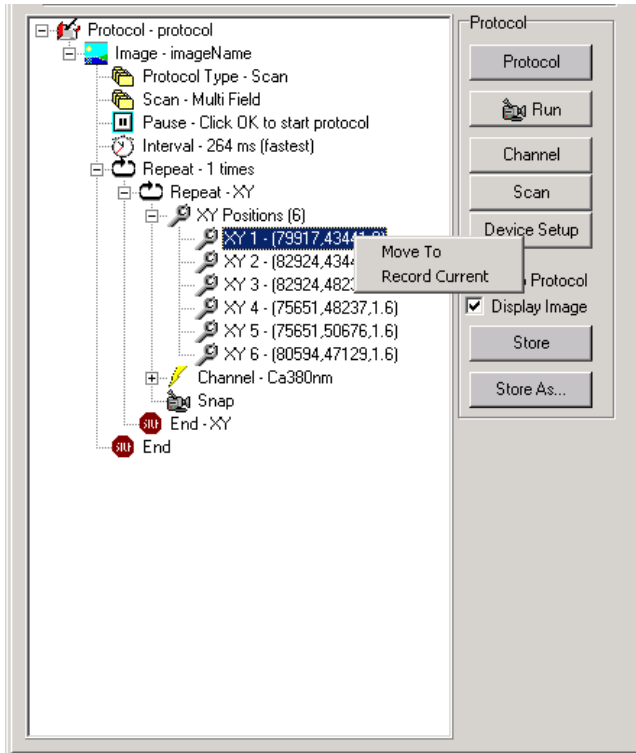

For the example shown, adjustments to the first XYZ position can be made using either the **Move To** or **Record Current** commands

Note: Autofocus – when you edit fields adjust Autofocus at the new field. Use the Device Setup dialog microscope tab. Then click the Initialize the Autofocus button in the GUI. iQ will indicate if the Autofocus was successful. When you click Record Current, iQ will record the current setting from the microscope.

4.3.7.3 Modifying a Z scan

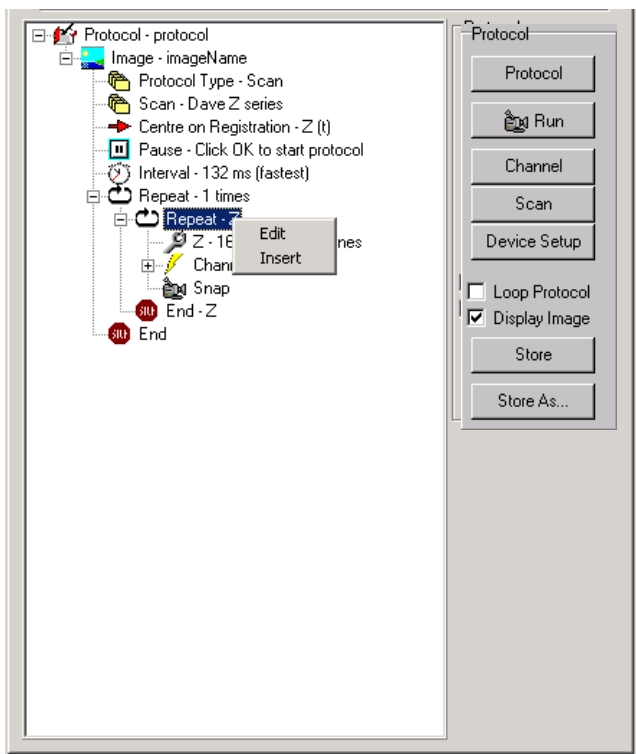

An expanded nD Protocol Tree corresponding to a Z series is shown on the left.

Clicking on **Repeat-Z** with the left mouse button and then clicking the right mouse button displays the **Edit** and **Insert** functions. Pressing the **Edit** button accesses the Scan Manager and allows the Z scan settings to be modified together with the channel specified for acquisition.

4.3.8 Focusing During a Scanned Acquisition

The microscope hardware Auto-Focus feature which corrects for focus drift during the execution of a Protocol has been explained. However, if this hardware is not available, you may find that during the execution of a scan or single field imaging it is necessary to adjust the focus because of thermal drift. The acquisition can be interrupted by pressing the **Live** button and refocusing the image. The effect of refocusing is to alter the coordinates of the scan. The acquisition is restarted by clicking on the **Idle** button after which the scan is reset to the first field and the Z stage coordinates at all XY positions are modified by the offset introduced in the refocusing step. A revised image series at that time point is acquired.

Please note, the resultant image data does not contain the new position stamps corresponding to the revised positions in the Z series. The Z positions calculated at the start of the acquisition are used.

For multi-field or multi-well protocols, the right mouse action on the current field is used to update the X, Y and Z values. This can be done sequentially on each field of the scan to ensure good focus throughout.

4.3.9 Editing a Systematic Scan

The coordinates for each field in a systematic scan can be recomputed based on uniform random sampling using the nD Protocol Tree.

The scan pattern is highlighted using the left mouse button and the **Edit** function accessed by clicking the right mouse button. Clicking on the **Edit** function launches the Scan Manager setup wizard, where modifications to the acquisition channel scan pattern type and number of sampling fields can be made.

If no changes are made to the scan pattern and the current number of fields is

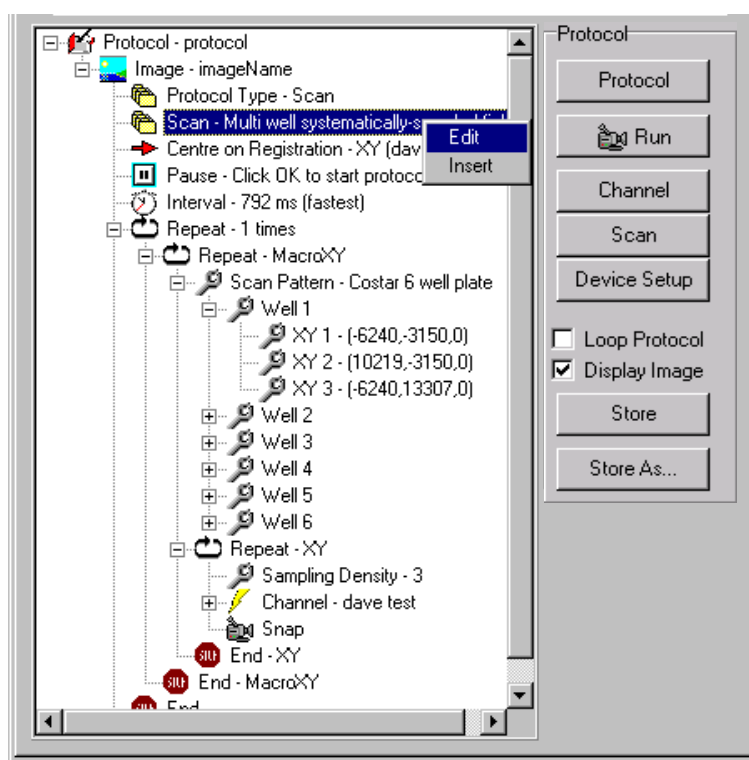

maintained, the positions of each XY pair are recomputed and the protocol can be subsequently repeated using a revised sampling set.

Note: Autofocus – when you want to set new Autofocus values at the new fields, you must visit the field, focus the specimen at that location and use the microscope tab on the Device Setup dialog to Initialize Autofocus for every field or well

as required. iQ will indicate if the Autofocus was successful. When you click Next Field or Next Well, iQ will record the current Autofocus setting from the microscope.

4.4 nD Protocol Tree Actions - Insert, Delete and Edit

4.4.1 Protocol Manager

Protocols are created and stored with a specific hardware Configuration and they are not accessible outside the Configuration. You can use this feature to allow different users to keep their Protocols private. This can be done by making a suitable configuration for each user (include the user's name in the configuration). In this way you can allow multiple users to control the same hardware, but maintain independent Protocols, Scans and Channels

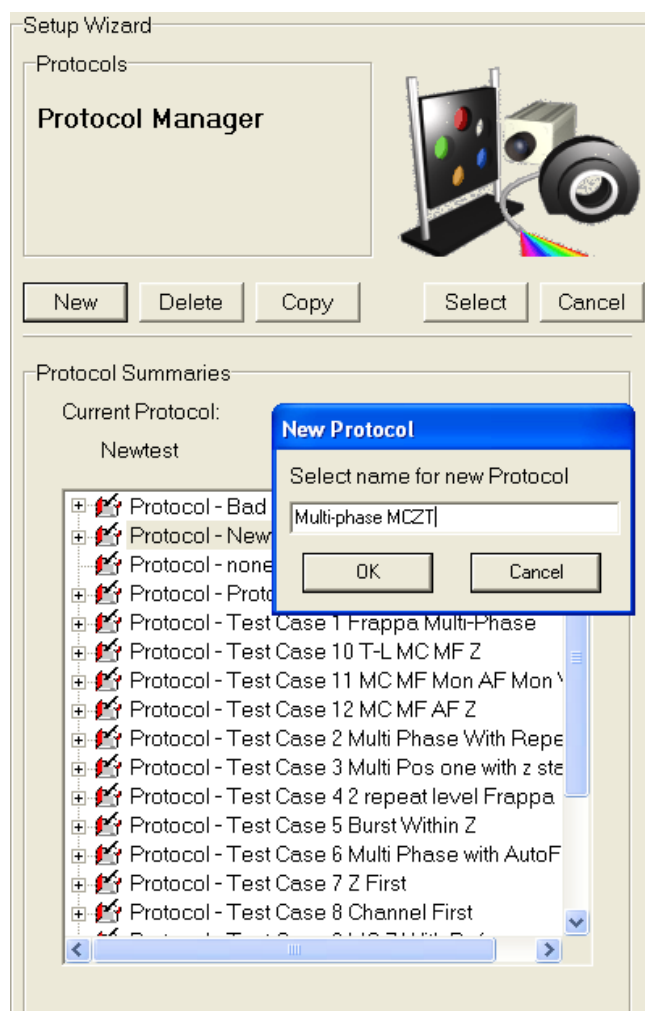

The Protocol Manager is accessed by clicking on the **Protocol** button on the Acquisition Page or from the Wizards menu. A Protocol contains a series of keywords which define Actions.

To create a new protocol is click **New**. Enter a name to identify the protocol. A prototype Protocol is then created and it can be edited either in the nD Protocol Tree or in the 6D view interface.

Once the Protocol has been created iQ will switch back to the Acquisition panel where you can edit as desired. Examples of Protocol editing are

reviewed in the next section.

Existing Protocols can be selected by highlighting the name in the Protocol Manager list and pressing the **Select** button. The nD Protocol Tree will be updated and from there it can be executed by clicking on the **Run** button the same applies to 6D view

interface. Modifications to any protocol can be made using edit boxes in 6D view or by using the right mouse edit functions in the nD Protocol Tree, the original protocol can only be overwritten by users with administrative rights.

Duplicate versions of any protocol can be created by highlighting the appropriate file name and pressing the **Copy** button. Files can be erased from the list by highlighting the appropriate file name and pressing the **Delete** button. **Cancel** exits from the Protocol Manager dialogue ignoring any changes.

Further details describing the creation of experimental protocols can be found in **Section 4.8.**

4.4.2 The Flexible nD Protocol Tree

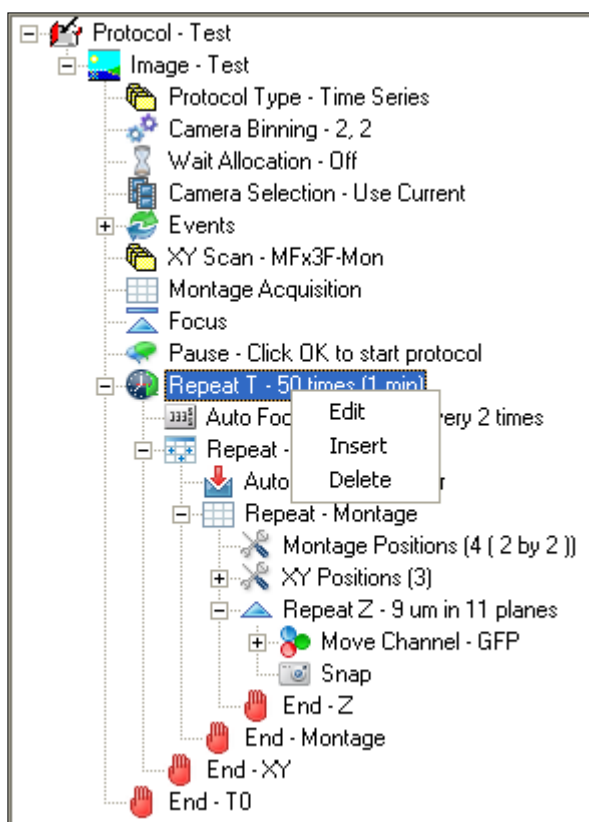

Andor iQ3 had a nD Protocol Tree. The nD Protocol Tree defines the acquisition Action sequence.

A typical nD Protocol Tree is shown left. All Trees, including prototypes, have a series of Actions which cannot be removed from the Tree. They are used for system-level control settings and some can be edited as discussed in **section 4.4.4.**

Selecting Edit on an Action item iQ will show an Insert Item dialog - **section 4.4.3** - from which you can choose, or a dialog allowing text or value entry.

To Insert an Action keyword into the Tree, you point to the Action above the insertion point and right click the mouse. A popup menu will appear as shown to the left and the new Action will be inserted directly below the selected item - in this case at the

Repeat Time Action.

In general insertion rules have been minimized to support Protocol flexibility. Where rules do exist, they are expressed by restricting the list of Action items presented in the Insert Item dialog.

4.4.3 The Insert Item Dialog

The Insert Item dialog shows the list of Actions which can be inserted at the selected point in the Tree. Each Action keyword has a name, an associated icon and a text

Hint to help you see its function at a glance. When you click an Action item in the list a text Hint is shown at the bottom of the dialog as highlighted left. We hope the Hints are instructive and clear, but if you need more clarification please read on where we provide more details for each Action.

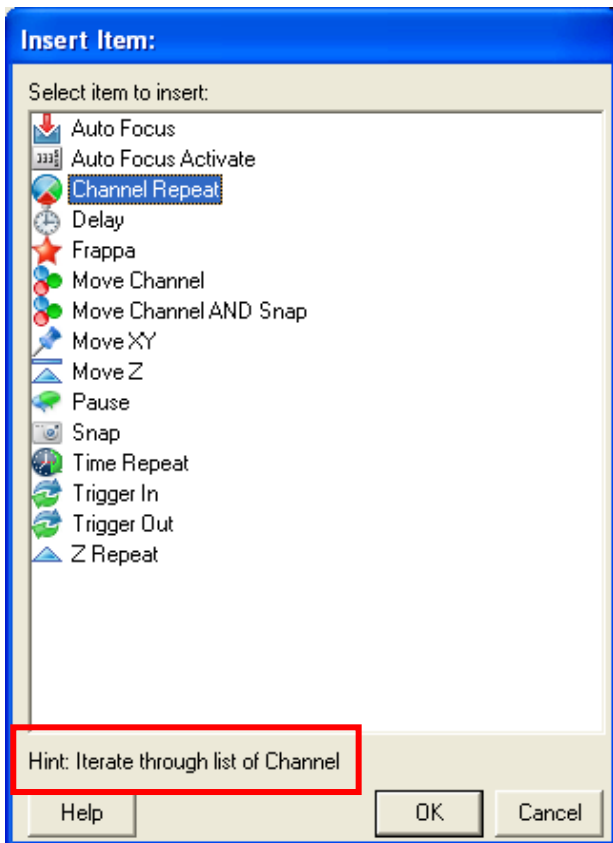

IMPORTANT NOTE: When you insert any **Repeat Action** an associated End Action will be included immediately afterwards. You can drag this End Action downwards to enclose the Actions you want to enclose e.g. Channels, Snaps etc.

A List of Action keywords and their Hints is shown in the next section and from there we explore each Action in more detail.

4.4.4 Action keywords an overview















Items here are coded as follows -

Red - Always in the Tree, but not in the Insert Item list

















Blue - Added to the Tree as part of an XY Scan. User can Edit via a popup menu on

any XY Scan component (blue).

Find the Action keyword in column 1 and then click on column 4 (with CTRL key) for more details.

<input type="checkbox"/> Keyword	<input type="checkbox"/> Icon	<input type="checkbox"/> Hint	<input type="checkbox"/> Click below
Auto Focus	<input type="checkbox"/> 	Execute Autofocus action	<input type="checkbox"/> Autofocus
Auto Focus Activate	<input type="checkbox"/> 	Specify frequency of Autofocus action	<input type="checkbox"/> Autofocus Activate
AutoSave	<input type="checkbox"/>	Not strictly in nD Protocol Tree, but related	<input type="checkbox"/> Auto_Save
Camera Binning	<input type="checkbox"/> 	Set camera binning to specified value	<input type="checkbox"/> Camera Binning
Camera Selection	<input type="checkbox"/> 	Select camera for current Protocol	<input type="checkbox"/> Camera Selection
Delay	<input type="checkbox"/> 	Wait here for defined period, d	<input type="checkbox"/> Delay
End x	<input type="checkbox"/> 	End of iterator loop type x - see Repeat x. End x can be dragged downwards to bracket other Actions	<input type="checkbox"/> End
Frappa	<input type="checkbox"/> 	Execute a Photo-stimulation action	<input type="checkbox"/> Frappa
Image	<input type="checkbox"/> 	Root name of the images created by the Protocol.	<input type="checkbox"/> Image
Load Protocol	<input type="checkbox"/> 	Load and execute Protocol at End of current Protocol	<input type="checkbox"/> Load Protocol
Montage View	<input type="checkbox"/> 	Show and execute Montage View	<input type="checkbox"/> Montage View
Move Channel	<input type="checkbox"/> 	Set devices to state recorded in Channel	<input type="checkbox"/> Move Channel
Move Channel AND Snap	<input type="checkbox"/> 	Set devices to state recorded in Channel and capture a frame	<input type="checkbox"/> Move Channel Snap
Move XY	<input type="checkbox"/> 	Set XY stage to specified position (with Z)	<input type="checkbox"/> Move XY
Move Ref Z	<input type="checkbox"/> 	Set Reference Z stage to	<input type="checkbox"/> Move Ref Z

Andor iQ USER GUIDE

		specified location	
Move Scan Z	<input type="checkbox"/> 	Set ScanZ stage to specified location	<input type="checkbox"/> Move Scan Z
OnLine Chart	<input type="checkbox"/> 	Show region of interest intensities in chart	<input type="checkbox"/> On Line Chart
Pause	<input type="checkbox"/> 	Show user-defined message and wait for OK	<input type="checkbox"/> Pause
Protocol Type	<input type="checkbox"/> 	for internal use only	<input type="checkbox"/>
Ratio	<input type="checkbox"/> 	Compute on-line Ratio	<input type="checkbox"/> Ratio
Repeat Channel	<input type="checkbox"/> 	Iterate through list of Channel	<input type="checkbox"/> Repeat Chanell
Repeat Montage	<input type="checkbox"/> 	Iterate through overlapping fields for mosaic	<input type="checkbox"/> Repeat Montage
Repeat Time	<input type="checkbox"/> 	Iterate n times with defined interval, t	<input type="checkbox"/> Repeat Time
Repeat Well	<input type="checkbox"/> 	Iterate a series of Wells in a multi-well plate	<input type="checkbox"/> Repeat Well
Repeat XY	<input type="checkbox"/> 	Iterate through XY coordinate list	<input type="checkbox"/> Repeat XY
Repeat Z	<input type="checkbox"/> 	Iterate a series of Z positions (Z scan)	<input type="checkbox"/> Repeat Z
Snap - Frame	<input type="checkbox"/> 	Acquire a frame	<input type="checkbox"/> Snap
Snap - Stream	<input type="checkbox"/> 	Acquire a frame in Stream mode – (device sync not guaranteed). Overlap ON/OFF	<input type="checkbox"/> Snap Stream
Trigger In	<input type="checkbox"/> 	Wait for specified Trigger input pattern	<input type="checkbox"/> Trigger In
Trigger Out	<input type="checkbox"/> 	Output specified Trigger output pattern	<input type="checkbox"/> Trigger Out
Wait Allocation	<input type="checkbox"/> 	Wait for image allocation to complete before	<input type="checkbox"/> Wait Allocation
XY Scan	<input type="checkbox"/> 	Iterate through XY coordinate list	<input type="checkbox"/> XY Scan

4.4.6. Actions in more detail

Autofocus - Execute an Autofocus action based on the currently selected device. This will typically be a microscope hardware autofocus action e.g. PFS, ZDC, DF. Note that the Autofocus device **MUST** be already initialized for this to function correctly. iQ will warn you if the Autofocus is not initialized when you try to Run the Protocol. The location of this Action within Repeat XY, Montage and Well will define whether Autofocus is executed for these fields.

Note also that Autofocus Activate Action (below) must be in the Tree inside a Repeat Time Action. [Return to [Table](#)]

Autofocus Activate - Specifies Autofocus Action periodcity. So if this Action takes the value 2 the Autofocus Action will be executed on every 2nd Time loop, or if the value is 3 it will be executed on every 3rd Time loop. This Action **MUST** be inserted at a Repeat Time Action. [Return to [Table](#)]

Camera Binning - Edit this item with *Use Current* and *Adjust Current*. In the *Use Current* case the Protocol uses the value of binning set in the Camera page of the Device Setup Dialog. Alternatively the binning value can be forced by using the *Adjust Cuurent* setting. When you select *Adjust Current* you will be directed to the Camera control page within the [Channel](#) wizard and the value you set here will be used within the Protocol. Note that the exposure stting is automatically adjusted e.g. at 2x2 binning exposure will be multiplied by $1/2 \times 2 = 0.25$. [Return to [Table](#)]

Camera Selection - Edit this item with *Current* or, if there is more than one camera loaded into iQ, with the camera *ID* specified in the Camera Selection page of the Device Setup Dialog. In this way a Protocol can be associated with a specific camera and you can switch cameras using the [Load Protocol](#) Action. [Return to [Table](#)]

Delay - Set a delay period (*ms, seconds, minutes, hours*) between Actions. This Action can be used to ensure that a state change e.g. [Channel](#) or [XY](#) has reached stability before proceeding. [Return to [Table](#)]

End - Always inserted with a Repeat Action and therefore associated with Montage,

T, Well, XY or Z e.g. “End T1” or “End XY”. If there is nesting of [Repeat T](#) loops, then each loop parameter has a postfix single digit T1, T2 etc and the associated End will have a matching index e.g. End T1, End T2.

IMPORTANT NOTE: When you insert any **Repeat Action** an associated **End Action** will be included immediately afterwards. You can **drag** this End Action downwards to **enclose** following **Actions** as you wish e.g. Channels, Snaps etc.

[Return to [Table](#)]

Frappa - execute a Frappa Action, specifying the device (FRAPPA, MicroPoint or Mosaic), Frappa Channel and “Single” or “All” regions. The last parameter defines whether the currently selected Frappa region will be stimulated or all Frappa regions existing on the Image Window. The Frappa Channels are defined in the Select Frappa Device item form the Wizard menu. You can use more than one Frappa device in a system. [Return to [Table](#)]

Image - Edit this item to specify the root name of the image(s) created by your Protocol. Note that this name can be used for AutoSave and so should not use illegal file characters such as “\” (backslash). [Return to [Table](#)]

Load Protocol - Load the named Protocol when the execution of the current Protocol has ended. This allows you to switch between different acquisition modes sequentially. A different camera can be selected in each Protocol if required. It is possible to create endless loops of acquisition which can only be halted by User input or a fault condition if a sequence of Protocol loads the next in a circular manner. When a Protocol loads itself this will become an endless loop and can be useful in various ways, e.g. to decimate storage activity (with AutoSave enabled) or provide bursts activity with known delays or with triggers. To make sure that Loaded Protocols do not “block” execution, ensure that no Pause Actions are in the nD Protocol Trees. [Return to [Table](#)]

Montage View - Creates a new image which is a mosaic or montage of the fields in a Montage scan. Can only be inserted into the Tree if a Repeat Montage exists in the Tree. Its location in the Tree determines the frequency of its execution. If within the Montage then every field will be updated in the Montage. If it appears outside of the

Repeat XY Action then it will only be called after the montage for all XY locations have been captured. [Return to [Table](#)]

Move Channel - Move the devices associated with a Channel name into the recorded state. This might include illumination and detection wavelength, optical configuration, camera settings etc. Channels can also be associated with FRAPPA actions or simply instrument states which are required for a given experimental protocol. [Return to [Table](#)]

Move Channel AND Snap - Move the devices associated with a Channel name into the recorded state AND acquire a frame. Acquiring a frame with Snap executes: Pre-frame action e.g. open a shutter; acquire a frame and; Post-frame action e.g. close a shutter. [Return to [Table](#)]

Move XY - Move the XY stage to the coordinates specified in the Action parentheses. The coordinates will be absolute if the Stage Registration wizard has been run. In other words you will have a common zero position between sessions and the coordinates will be re-usable. By default the XY and Z coordinates at the current position will be selected and specified in the Action. But you can drive the stage with joystick (or GUI if one exists) to a desired location and then right mouse click and select Record Current. You can also select Move To from the right mouse Edit list if you want the stage to go to the recorded coordinates immediately. [Return to [Table](#)]

Move Ref Z - Move the Reference Z devices stage (or Objective) to the coordinate specified in the Action parentheses. The coordinates will be recorded from the Reference Z device which is selected in the Select XYZ Device under the Wizard menu. If you switch between Z devices in a session e.g. between microscope and Piezo, then you should Edit the Move Ref Z Actions to avoid out-of-range or risk of collision between the objective and stage. [Return to [Table](#)]

Move Scan Z - Move the Scan Z devices stage (or Objective) to the coordinate specified in the Action parentheses. The coordinates will be recorded from the Current Scan Z device which is selected in the Select XYZ Device under the Wizard

menu. If you switch between Scan Z devices in a session e.g. between microscope and Piezo, then you should Edit the Move Scan Z Actions to avoid out-of-range or risk of collision between the objective and stage. [Return to [Table](#)]

On-Line Chart - Insert the on-line graphing tool. This tool will show a graphic which is updated on frame Snaps, showing the mean in regions of interest drawn onto the iQ Image Window. It can also show the mean of ratios of the regions when two or more channels are present in the Protocol. [Return to [Table](#)]

Pause - Pause lets you enter text which will be shown on a Windows Message Box with an OK button. Execution of the Protocol will Pause until a User clicks on the OK button. You can use the message to give instructions to the User or to make sure certain conditions are fulfilled prior to continuing e.g. adjust some manual equipment such as switching a port or opening a shutter. [Return to [Table](#)]

Ratio - Allows you to specify an on-line image ratio. When you insert the Action, iQ guides you through a setup Wizard in which you define Numerator and Denominator of the Ratio and you can capture two channel images on which to define the Ratio settings. With the interactive tools available in the Wizard you can specify the background for subtraction either by stored image or region of interest on the image. After background subtraction the ratio is computed pixel-by-pixel for non-zero values and the floating point result is displayed in a second image tab in the Image Window so that it can be viewed during acquisition. You can Edit the Action to change the settings if you wish. [Return to [Table](#)]

Repeat Channel - Iterate through a list of Channels held in the parentheses. When you insert this Action, iQ allows you to choose from the Channel Wizard the first of a list of Channels to be looped. This is an efficient way of defining Channel sequencing. The right mouse menu on this Action allows you to Add and Remove Channels from the list. [Return to [Table](#)]

Repeat Time - Iterate a number of times with a defined interval. When you Edit this Action you get a dialog to Edit both number of Repeats and Interval. When the *Protocol is running*, if you right mouse on the Action you can *Edit the interval*, but not

the number of repeats. If you use Interval Setup under the Settings menu, then you can create a predefined list of intervals from which you can select during Protocol execution. [Return to [Table](#)]

Repeat Montage - Iterate through a series of Montage fields. This Action is implicit within the XY Scan settings it is not inserted independently. If this Action is deleted the entire XY Scan will be removed from the Tree. If you choose to Edit this item it is possible to Edit the entire XY Scan. [Return to [Table](#)]

Repeat Well - Iterate through a series of Wells in a multi-well or microtitre plate. This Action is implicit within the XY Scan settings it is not inserted independently. If this Action is deleted the entire XY Scan will be removed from the Tree. If you choose to Edit this item it is possible to Edit the entire XY Scan. [Return to [Table](#)]

Repeat XY - Iterate through a series of XY fields, with optional Montage and Well iterators if defined in the XY Scan. In the Insert Item dialog you select an **XY Scan**. Note that you can insert **only ONE XY Scan in the iQ nD Protocol Tree**. The field coordinates will be absolute if the Stage Registration wizard has been run. You will have a common zero position between sessions and coordinates will be reusable. The XY and Z coordinates of the fields are listed under the **XY Positions** keyword and can be Edited in the Tree by driving the stage with joystick (or GUI if one exists) to a desired location and then right mouse click and select Record Current. If you select Move To from the right mouse Edit menu the stage will go listed coordinates immediately. [Return to [Table](#)]

Repeat Z - Iterate through a series of Z planes to create a focus series. Specify number of planes, n ; range of motion, m μm ; step size, $\Delta z = m/(n-1)$. Z Scans are computed relative to the current position, z_c as center. This makes the maximum and minimum z values, $z_{\text{max}} = z_c + m/2$ and $z_{\text{min}} = z_c - m/2$. If you have more than one Z control e.g. microscope and Piezo stage you can choose which one to use for the scan execution. In the XY Scan Wizard you access the Select XYZ dialog and choose the device. [Return to [Table](#)].

Snap - Frame - Acquire a single frame from the camera with the following sequence.

Open the shutter(s) with Open-Close status (preframe action), trigger the camera, wait for the exposure time, Close the shutters with Open-Close status (postframe action), and transfer the data to the ImageDisk. This action will communicate a message the Image View to display the frame if the “Display Image” check box is selected on the Acquisition tab at the bottom of Protocol-related buttons.

Note: The timestamps for snapped frames are added as the frames are acquired. Due to software jitter and varying time for device movements this may mean that the timestamps for images are not uniform. The recorded time is a truer acquisition measurement compared to a computed timestamp. [Return to [Table](#)].

Snap - Stream (Overlap ON/OFF) - Acquire a series or burst of frames from the camera while the camera is set to Free Run (Stream) mode. The sequence differs from Frame mode (above), in that frames are not triggered one by one, but are taken as soon as they become available. The camera is continuously acquiring and at the end of each exposure iQ will start to move devices (if required) during the camera readout period. Hence **synchronization** will depend on the speed of the devices and is **not guaranteed**, but is recommended for fast devices like Piezo Z, Laser combiner (AOTF) or other fast light sources. Slower devices may not be synchronized. Devices which can stabilize within the camera readout period will ensure the highest performance. If synchronization is unreliable then revert to Frame mode.

If Overlap is set to ON, the camera will run in Overlap or Frame Transfer mode and achieve maximum frame rate. Pre-frame and post-frame actions are executed so fast shutters can be used, but may be unnecessary.

Note: As the camera is running continuously in Stream mode the fire pulse will be generated continuously. When using an ALC device with the fire pulse connected to the Active Blanking input this can have undesirable behavior.

Stream mode is not suitable for use with the Andor FRAPPA device. This device relies on the Active Blanking capability of the ALC to draw shapes but the fire pulse will be high when the FRAPPA device is firing.

Also, Stream mode is not suitable when using the ALC with large delays between snaps e.g. use of intervals. The sample may be over-bleached by the continuation of the fire pulse when iQ is paused in the interval.

Snap Frame mode is recommended to ensure correct behavior for these scenarios.

Note: The camera Fire signal may not reflect exposure state when running in Frame Transfer mode. If this is the case then include Trigger and Event device control in the Configuration and ensure that PCU or BOB DO2 is set to High or “1” at Preframe and Low or “0” in Postframe. Couple the DO2 signal to one of the Active Blanking Inputs on the rear of the PCU (for Laser combiner) or other fast (ms) shutter input on other sources. [Return to [Table](#)].

Note: Snap stream in SCMOS cameras introduces the “Frame Rate Control” option (FRC). Enabling the FRC check box allows users to control the camera acquisition speed and change it from the maximum frame rate that the camera can acquire to the user’s desired frame rate. For SCMOS 3 tap camera, enabling FRC and setting the frame rate to 30 fps (the exact value varies depending on the camera type and the sub area) prevents the lag appearing in images which is due to camera buffer filling up. Enabling the “Sustainable Frame Rate” check box under FRC settings adjusts and sets the camera acquisition speed to avoid overfilling camera RAM. FRC feature is not available with certain combinations of camera settings, such as rolling shutter and overlap on; as well as short exposures and rolling shutter when overlap is off.

Trigger In - Wait for a Hi or Lo TTL level on a user-selected bit from 8 TTL inputs. The digital pattern is shown in the Tree as two groups of four binary patterns (XXXX,XXXX) corresponding to the TTL inputs (DI7-4, DI3-0).The hardware TTL inputs are handled by either the Andor PCU100 series or the Andor BOB-100D or BOB-100A interface modules. You can use these inputs to synchronize iQ execution to external Events and monitor external hardware. [Return to [Table](#)].

Trigger Out - Output a Hi or Lo TTL level on a user-selected bit from 8 TTL outputs. The digital pattern is shown in the Tree as two groups of four binary patterns (XXXX,XXXX) corresponding to the TTL outputs (DO7-4, DO3-0). The hardware TTL outputs are handled by either the Andor PCU100 series or the Andor BOB-100D or BOB-100A interface modules. These outputs can be used to synchronize iQ execution to external processes and/or control other hardware. For example many perfusion systems have external TTL inputs for valve control and electrophysiology apparatus has external TTL trigger inputs.

Note that you can include **TTL Trigger Out actions as part of a Channel** as Preframe and Postframe actions. If you use Triggers you can set Transition and Duration delays of TTL pulses in the Device Setup Dialog. [Return to [Table](#)].

Wait Allocation state - instructs the Protocol how to handle image allocation on the ImageDisk. If state is *OFF* iQ will start execution of the Protocol while Allocation proceeds. Allocation is usually faster than acquisition - 500 image file allocations per second are not uncommon, but can impact performance. To minimize starting delays leave the state *OFF*, especially if your Protocol captures many frames and you do not have high performance demands.

If state is *ON* iQ waits for Allocation to complete before continuing. If you need high performance, then the *ON* state is preferred. The system can be left to self-start after Allocation. If you leave the system to self-start make sure there are no Pause Actions following Wait Allocation. [Return to [Table](#)].

XY Scan - shows the XY Scan name currently in the Tree. When you insert an XY Scan in the Tree it creates a [Repeat XY](#) iterator, and, if the XY Scan includes Montage and Well settings, also a [Repeat Montage](#) and [Repeat Well](#) iterator. Note that [Autofocus](#) can be used on all these settings, provided the Autofocus device has been initialized when Protocol execution begins. [Return to [Table](#)].

AutoSave - is controlled by the checkbox and path setting shown below, which is resident on iQ's Acquisition page. If the box is checked, iQ saves the Protocol image data when the Protocol ends execution. Images are saved in multi-page TIFF files with the root name specified in the [Image Action](#). iQ will add date and time postfixes to the filename. The folder name where the data will be saved can be set by clicking on ellipsis button (...). [Return to [Table](#)]

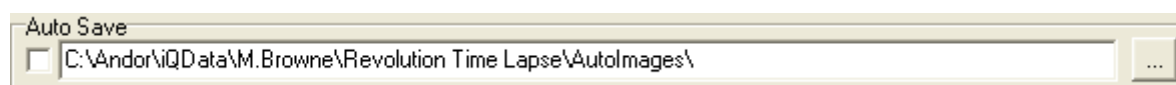

4.5 Protocols - basics

In this section we look at how to create and edit Protocols for some specific scenarios.

4.5.1 Creating a Two Channel Time Series Protocol

The following example describes a protocol used for dual excitation ratio imaging measurements using the Calcium ion indicator Fura-2. Fura-2 is excited sequentially at wavelengths, 340 and 380nm, when in the presence of calcium ions Fura-2 shifts

its absorption spectrum, changing the resulting emission intensities whose emission image ratio 340/380 is used to determine Ca^{2+} concentration.

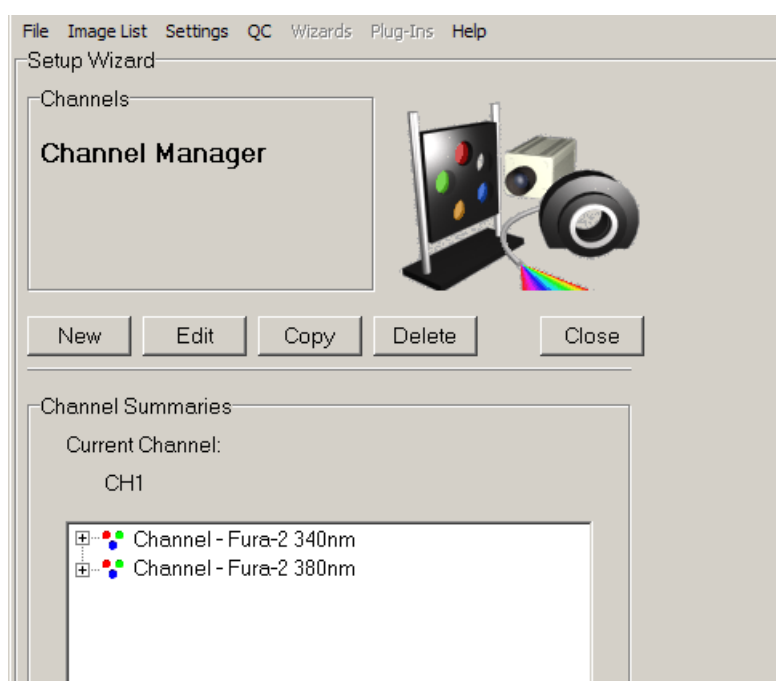

In this example a Monochromator is used as the excitation light source. Use the Channel Manager to create 2 Channels Fura2-340 and Fura2-380.

The channels are now available for incorporation into a New Protocol.

The example shows a channel summary for the two required channels. The **Fura-2 380nm** channel was created as described previously.

Click on the **Close** button to exit the Channel Manager.

Create a new Protocol with steps previously explained in [section 4.4.2](#). Insert the two Channels **Fura-2 340nm** and **Fura-2 380nm**. Edit the **Repeat** and **Interval**

settings to define number and frequency of image pairs to acquire. Note that you can either create two Move Channel AND Snap actions or you can use a Repeat Channel action - see below.

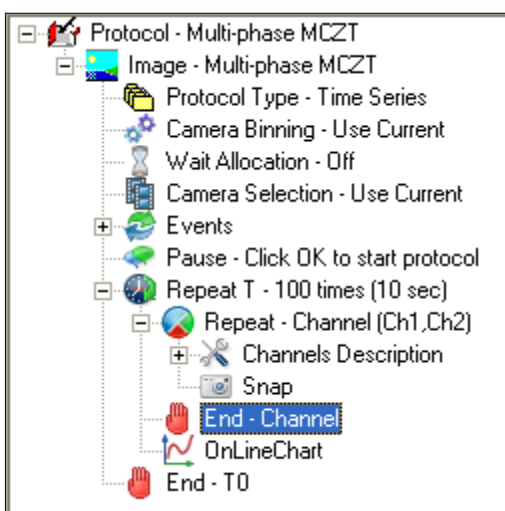
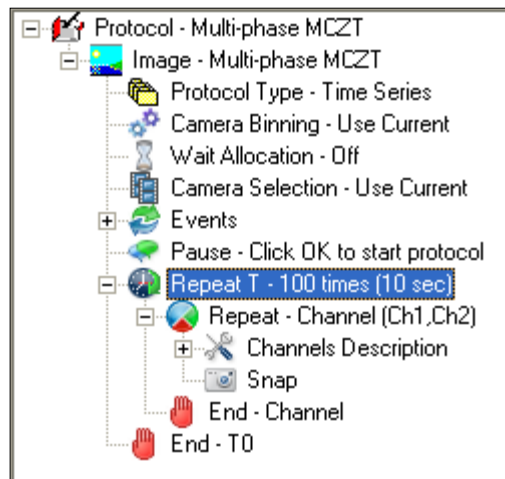
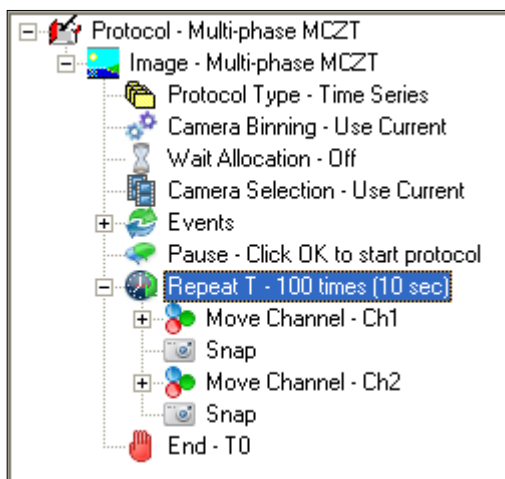

The **Online Chart** is used to monitor channel intensity in regions of interest during Protocol execution. **Online Chart** can be inserted into the nD Protocol Tree after the **End Channel** action as shown below.

The on-line **Ratio** processing keyword may also be inserted into the protocol, but instead of charting ROI intensities, it will compute a pixel by pixel ratio between the two channel images. To configure the details of processing, you can right mouse on the **Ratio** keyword and then choose Setup. More details of the **Ratio** action are described in **Section 4.8.4**.

For the most precise processing of Fura and other ratio image data, iQ provides the **Ratio plugin**. A detailed example of the use of this plugin is presented in **Section 6.11**.

4.5.1.1 On-line Charting

The On-line chart tool enables acquired data to be visualized in real time, intensity parameters are updated live, during the course of an experiment. Data charting is enabled by inserting the On-line chart keyword into the nD Protocol Tree.

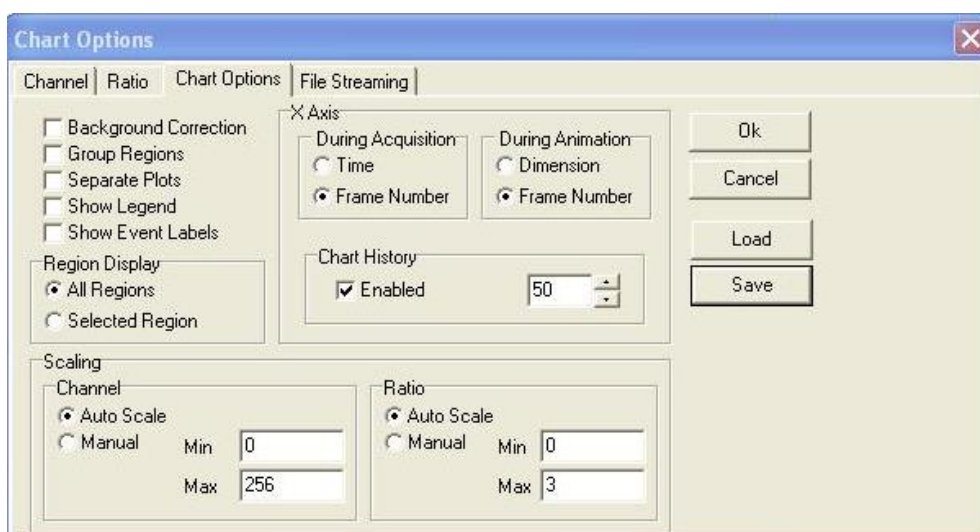

When the On-line chart is in Setup mode, the user is shown the dialog above to specify the channel or channels to be charted under the Channel Tab. A Ratio chart can be selected using the Ratio Tab.

To display the options window again, right-click the On-line Chart node in the tree and select **Edit**. Once you have modified the settings, close the window. The settings will be saved with the protocol.

Note: Updating the options of the Chart Image plug-in (available from the View menu) has no impact on the On-line Chart settings.

Expansion of the nD Protocol Tree in the example illustrated above shows the inserted **Online Chart**.

When the protocol is executed, the on-line chart is displayed on the screen and the time interval over which the data is plotted may be adjusted using the **Chart History** spin buttons. The user can also insert into a Protocol with a Right Mouse on Snap, however this is not applicable for Fast Protocols.

An example On-Line Chart window is illustrated below. There are two tabs on the side of the graph. One is for the Channel data and the other is for Ratio data.

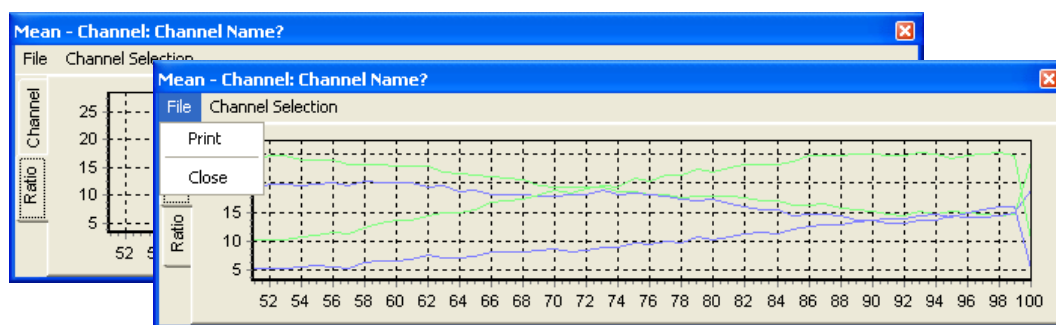

On completion of the experiment the charted data can be printed for further inspection and evaluation using the **Print** option in the **File** menu.

Click the **Close** button to exits from the On-Line Chart window.

4.5.1.2 Chart Options

Chart data presentation depends on settings specified in the **Chart Options**, **Channel and Ratio Tabs**. A discussion of IQ Analysis features in conjunction with the use of regions of interest is described in [Section 5.5.3](#).

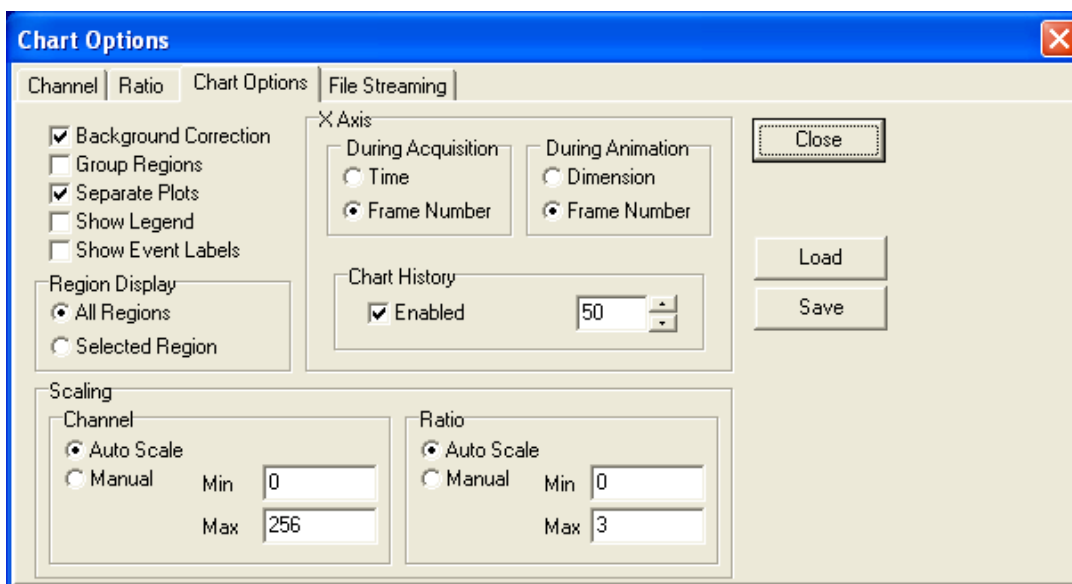

Select **Close** to accept any changes and exit the chart Options window. Settings can be recorded for future use with **Load** or **Save** buttons on the right hand side of the Chart Options Tab.

4.5.2 A Multi-Channel Protocol with Z-Scan

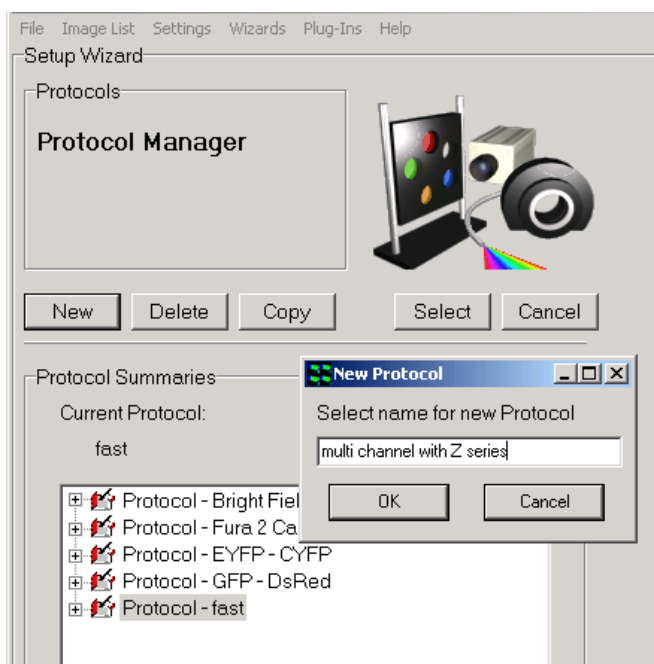

Follow the procedure to create New Protocol, or Edit the existing 2 channel Protocol.

Insert Repeat Z action into the Tree. Note you can insert in more than one location and get different effects. As soon as you select the Repeat T from the Insert Item dialog and click OK you are switched to the Z definition Wizard to assign settings.

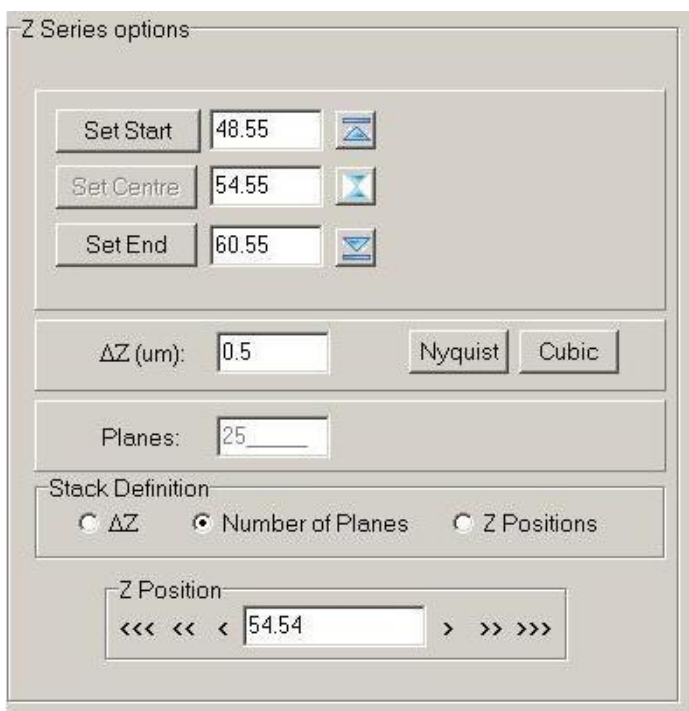

Andor iQ USER GUIDE

When you insert Repeat actions, a matching End action will be inserted. If you want to execute any actions within the Repeat loop you have to drag the End down the Tree. You drop the action keyword (End) on top of the action you want to appear after the End.

The example protocols below show inserting a Z scan and dragging the End to encompass several tree elements. On the left, the Z has been inserted above the repeat channel. It does not contain any acquisition elements. On the right, the nD Protocol Tree is shown with the End of the scan being dropped into position. End Z is located after End Channel after completing the drop.

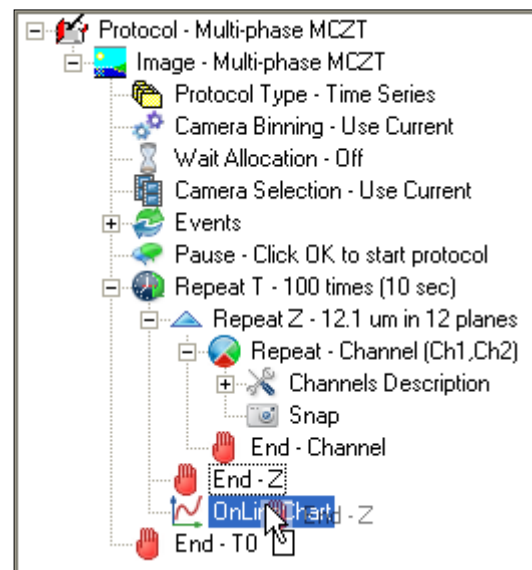
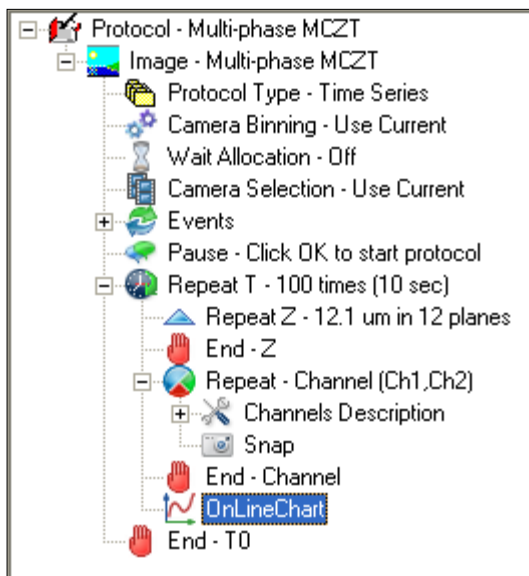

Note the Z scan uses relative Z values, (12.1 μm in 12 planes) and by default iQ assumes the current Z position before and after the Repeat Z is the middle of the scan. This then allows for more than one Z scan with different ranges if required.

When you are happy with the new protocol, click the **Run** button.

Note: Autofocus and Editing for New Specimens

If you have inserted a Autofocus action (and Activate (interval)), make sure you initialize the Autofocus hardware BEFORE you Run the Protocol, otherwise you will see an error message and warned to initialize again.

If you are scanning a **new specimen or a new well plate (even of the same pattern)** then you will need to **Edit the Scan** from the nD Protocol Tree or Scan Wizard. When you get to the field review part of the Wizard, you must reset all of the Z values and initialize Autofocus at every field or well. Make sure that you have the Device Setup dialog visible and the microscope tab is selected. Then click on the **Initialize the Autofocus** button in the GUI for each field required. iQ should indicate if the Autofocus was successful. When you click **Next Field or Next Well**, iQ will record the Autofocus setting from the microscope. Press **Continue**.

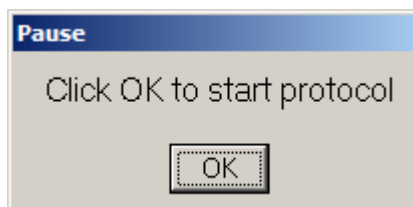

Press **OK** to start the protocol.

4.6 Flexible Protocol Patterns

The new flexible Protocol system provides so many possibilities it is not possible to list them all. However, as you gain familiarity in creating and editing Protocols you will notice “Patterns of Actions” which recur. In this section we illustrate ten Use Case patterns which have been used in testing iQ3 nD tree view and to establish its functionality within the design parameters.

4.6.1 Multi-Phase Protocol for FRAPPA

FRAPPA protocols require at least 3 distinct phases. These are baseline measurement, bleach and recovery measurement, followed by analysis to measure the T1/2 recovery time, which can be used to estimate diffusion rates. The Protocol below shows this pattern, which can be easily created with the tools illustrated in previous sections.

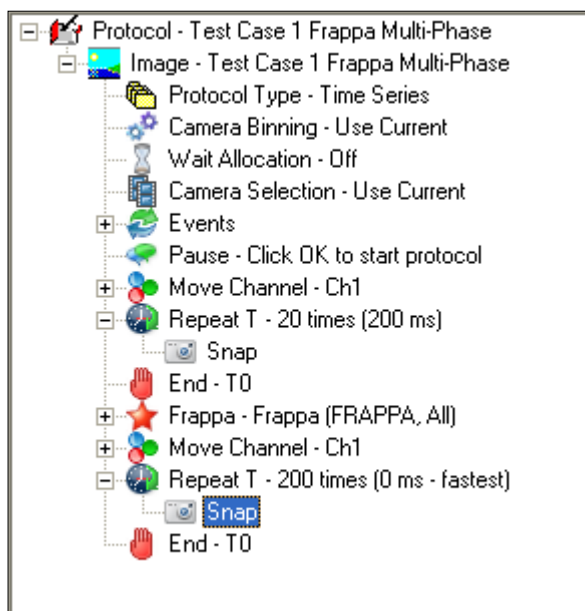

4.6.2 Repeating Multi-Phase Protocol for FRAPPA

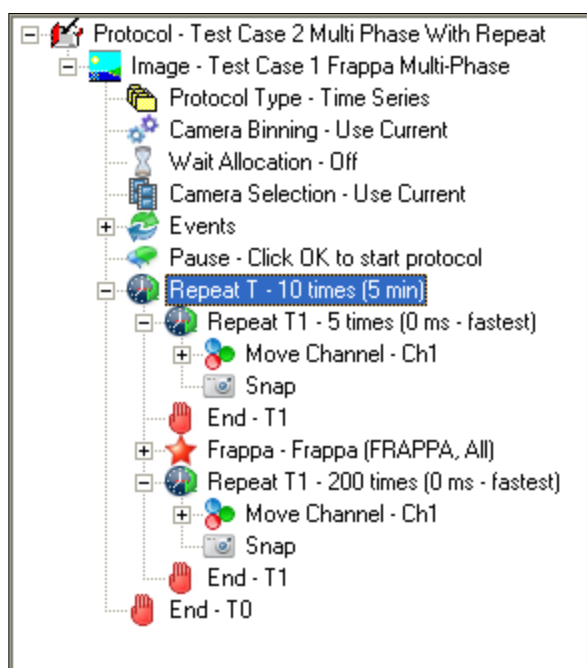

The FRAPPA protocol described above can be extended to provide repeated measurements of the process. This could be achieved by repeated bleach-recover actions on the same region or by moving the FRAPPA ROI(s) around. This is easy to achieve by introducing a new Repeat Time loop around all actions specified above as shown in the Tree below.

4.6.3 Time-Lapse Z Stacks with fast Burst at each Z

This Protocol allows the capture of slow developmental events with a 5 minute sampling interval (5 hours observation in this case), while also capturing fast bursts

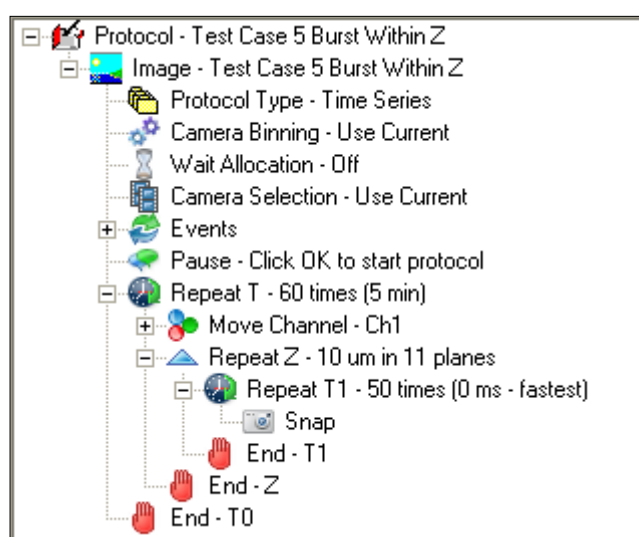

(50 frames) of physiological activity at different Z planes throughout the 5 hour process. This kind of information is important in developmental biology applications, where there are two time-bases of interest to scientific study.

4.6.4 Multi-rate, multi-phase with Autofocus

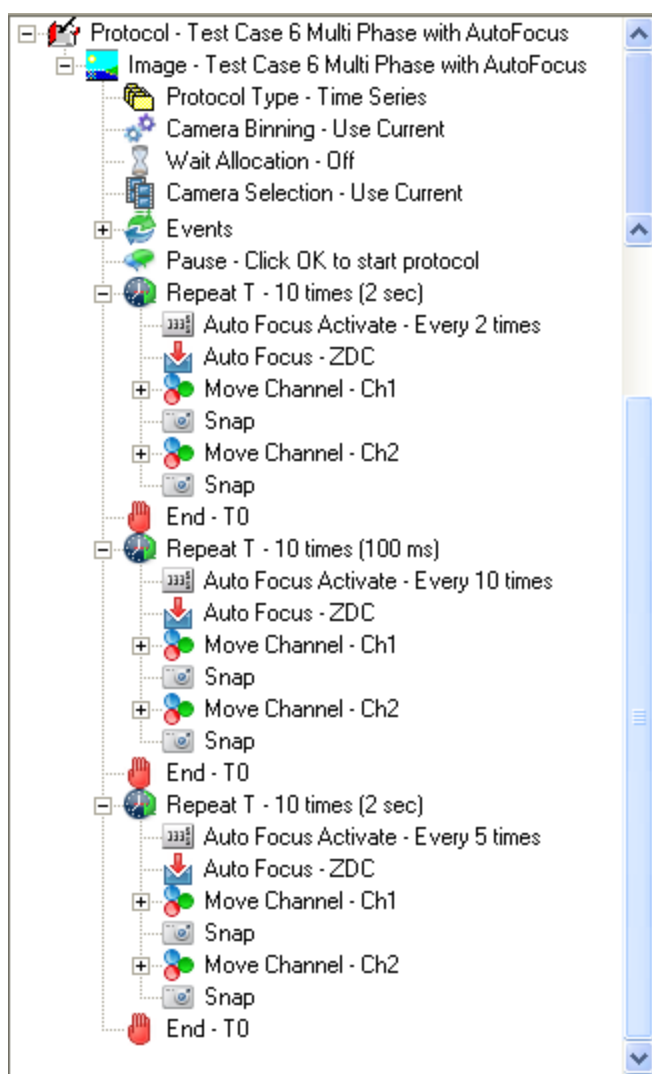

This Protocol contains sequential phases of acquisition with different frame rates in each phase. Each phase needs to run with precise inter-frame timing, but the intervals between phases are long enough for focus drift to be problematic. So in this Protocol we introduce Autofocus actions within between phases to maintain focus. Note the new Autofocus Activate keyword, which allows you to specify the interval between Autofocus actions.

4.6.5 Multi-Channel Time-Lapse with Z Stacks (Z moves first)

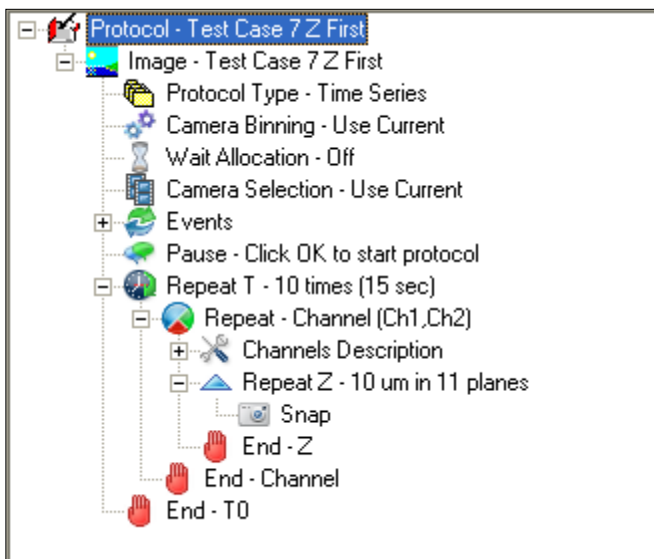

This Protocol was built to ensure that functionality previously available in FLZ will function in iQ3 nD tree Protocols. Note here also the use of the Repeat Channel iterator as a compact means of expressing the order and list of Channels.

4.6.6 Multi-Channel Time-Lapse with Z Stacks (Channel first)

This Protocol is paired with 4.6.5 to ensure that functionality previously available in FLZ is functional in iQ3 nD tree view Time Lapse. In this case we simply change the

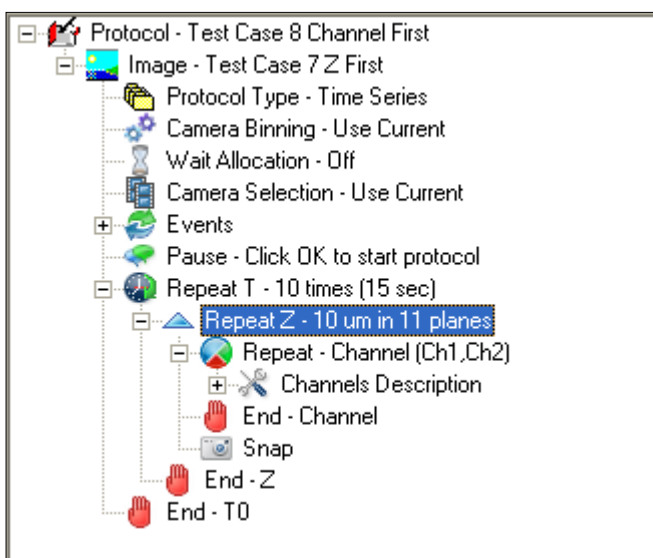

order of Repeat Channel and Repeat Z, so that the Channel now is the first to iterate.

These Protocols are important for flexible control and optimizing acquisition speed depending on which hardware is slower - Z scanning or excitation and emission wavelength switching.

4.6.7 Multi-Channel Z Stacks with Different frequency DIC

It is common to acquire multi-channel images at different rates for the channels.

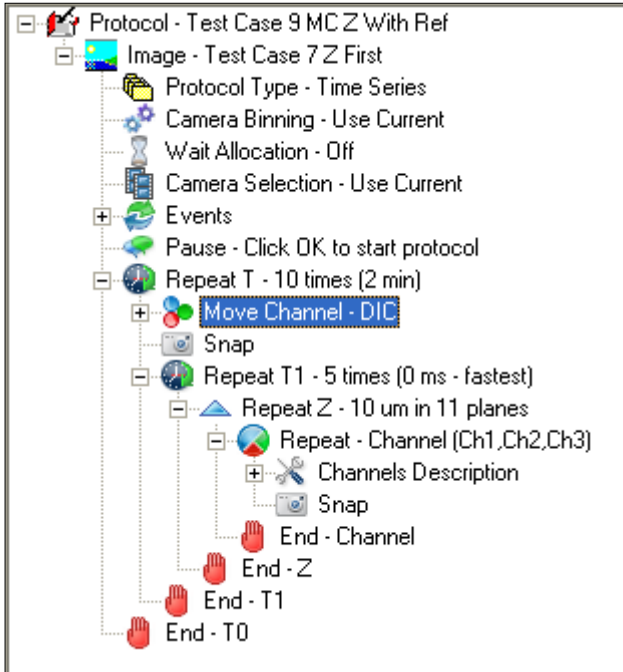

One example of this is in capturing a reference image while observing fluorescence dynamics, such as signaling or translocation. This example Protocol shows a DIC channel being acquired at a rate of one fifth that of the 3 channel fluorescent stacks.

4.6.8 Multi-field, Multi-Channel, Z Stacks with Autofocus

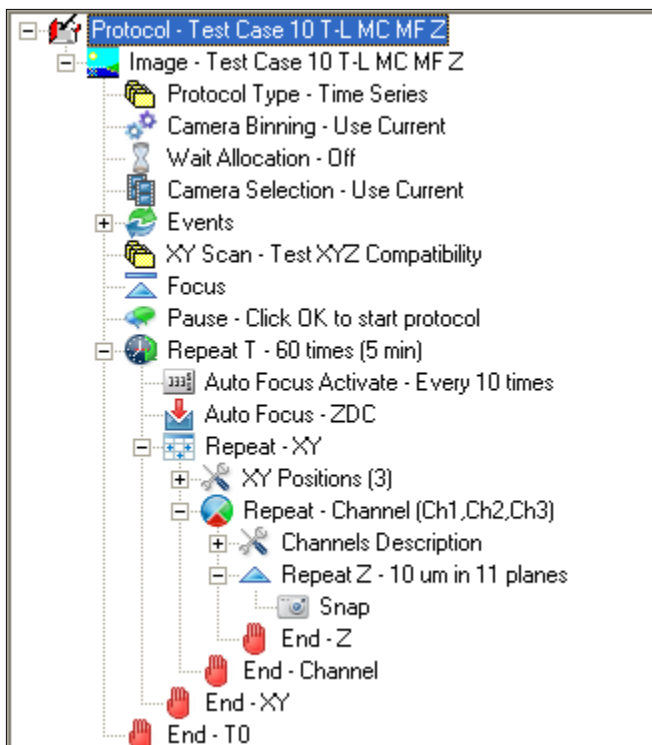

This is a regular Protocol for multi-dimensional image acquisition. By regular we mean that the frequency of acquisition is consistent for all fields, Channels and Z values. This kind of Protocol results in a single nDim because it is regular.

4.6.9 Multi-field, Montage + View and Multi-Channel

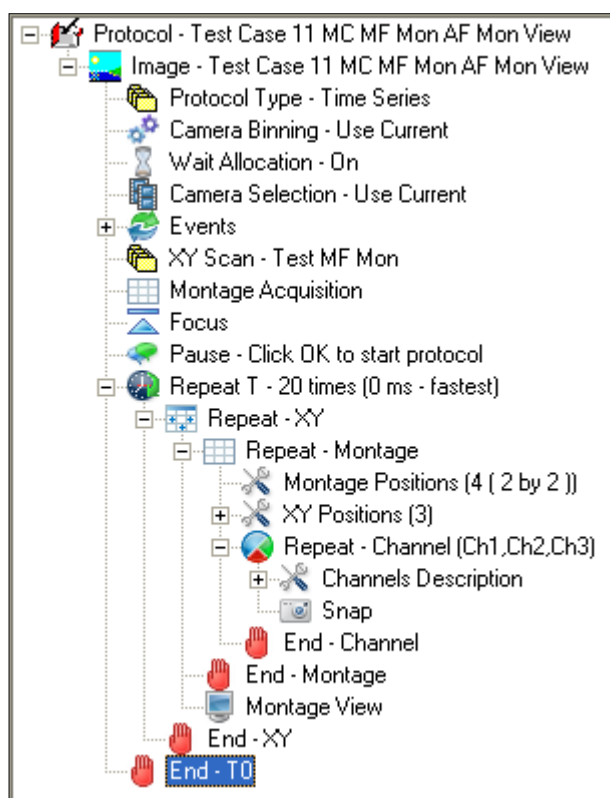

This is a regular Protocol for multi-dimensional image acquisition. Regular is as explained above. It shows the way in which the XY Scan can produce a Repeat Montage loop when it is inserted into the Tree.

4.6.10 Multi-field, Multi-Channel, Z Stacks with Autofocus

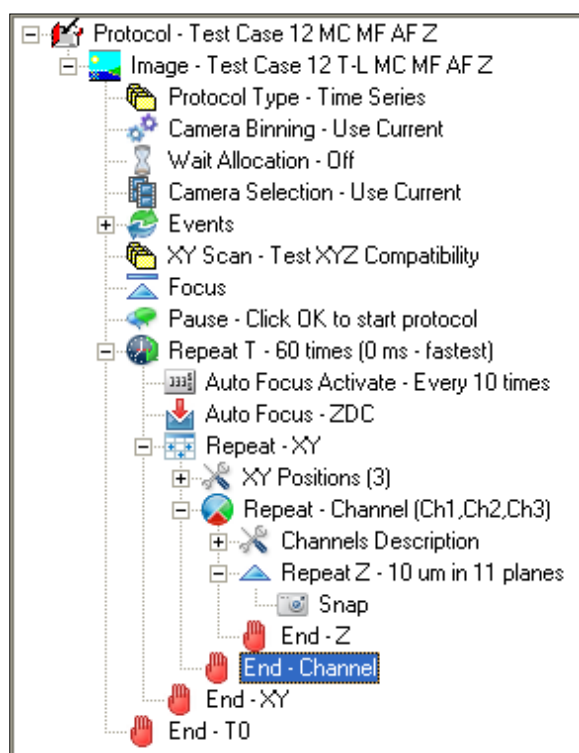

This is a regular Protocol for multi-dimensional image acquisition. By regular we mean that the frequency of acquisition is consistent for all fields, Channels and Z values. This kind of Protocol results in a single nDim because it is regular.

4.6.11 Protocol Templates

In order to make protocol creation easier we have added Protocol Templates. These are special predefined protocols that allow the user to quickly create one of the patterns described previously. When a new protocol is created, a new wizard panel is displayed; this prompts for protocol name but also allows a template to be selected.

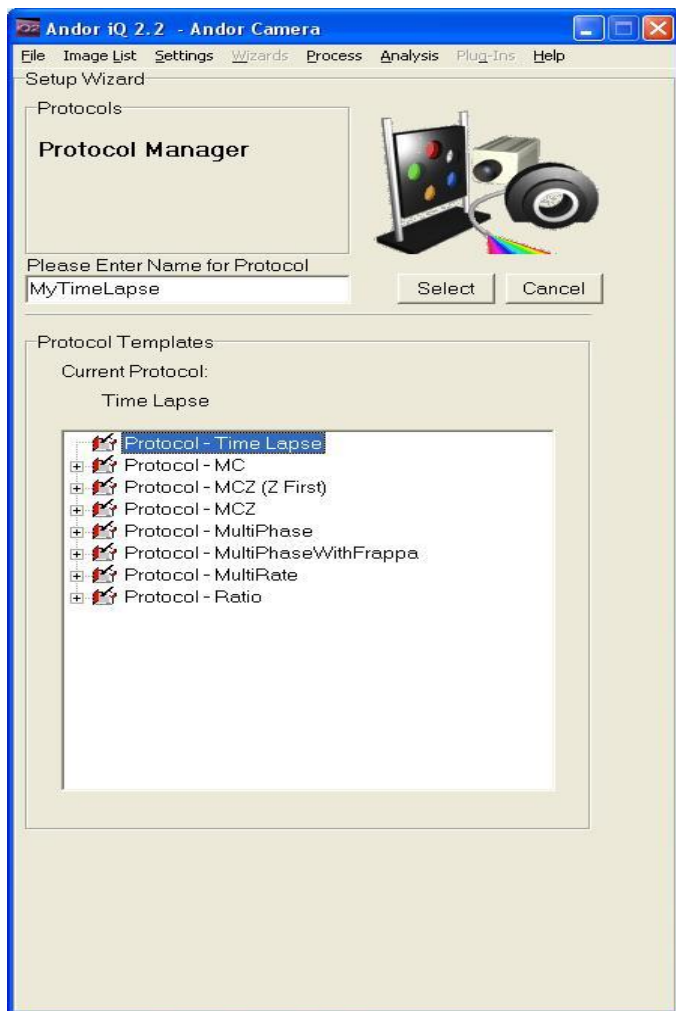

Several templates are provided with the iQ installation. Advanced users may create additional templates as described in the Appendix.

4.6.12 Drag and Drop Capability

In addition to the templates, drag and drop capability has been added to the nD protocol tree. Left click on a tree item, hold down the mouse button and begin to

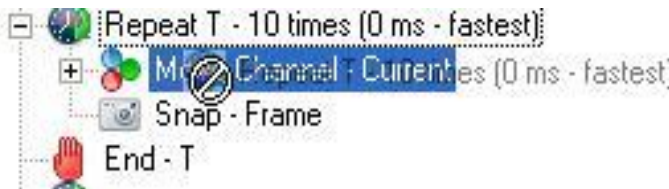

drag. Release the mouse to insert the item at a new location. There are protocol rules that restrict which items can be dragged and the

location that items may be dropped. When an item is restricted you will see a restriction icon. Here an attempt was made to drag the repeat inside itself, which is an invalid action.

When an item is allowed to be dropped you will see the following icon (Left). Here the end is being dragged within the repeat loop, this is a valid action. Resulting in the Snap being removed from the repeat loop (Right).



Repeat Loops may be dragged. All items within the repeat and end will remain intact. A repeat may not be dragged inside itself but may be dragged within another repeat loop, so long as it is not a child of the loop being dragged.

Channel repeat should not contain any Move Channel items. Dragging a Move Channel into the loop is not permitted. Dragging the end node around a Move Channel is permitted, to allow an intermediate state while editing the tree, but you will be warned that this will cause undefined behavior.

Due to the complexity of the XY scans, these repeat loops cannot be dragged, doing so would invalidate the structure of the scan. The end nodes may be dragged internally to allow items to be accepted into and rejected from the loop.

4.6.13 Irregular Protocol Structures

The flexible nD protocol tree allows a user to create very complex acquisition sequences. In order to manage the data sets more easily, iQ breaks the image dataset into regular channel based sub-images. These are joined together into a single image using what we refer to as a Constructor. The Constructor allows the irregular data set to be managed as a single object. Each sub-image is visible within the Image Manager; they appear below their associated constructor. Whenever possible iQ will try to allocate a single regular data set, in which case there will be no constructor.

4.6.14 Flexible Protocol Conclusions

We hope you find that flexible Protocols in iQ3 nD tree view allow you to carry out new and exciting experiments which were not possible before. We welcome your feedback, comments and suggestions.

4.7 Multi-camera acquisition

In versions of iQ since 1.8 we have provided support for handling multiple cameras on a single Windows workstation. In the 1.10.2 release we improved performance and management of multi-camera scenarios as this becomes increasingly popular. A single instance of iQ allows the control from two or more Andor cameras, but not third party products. IQ can be configured to allow sequential operation of cameras in a single instance or parallel operation of cameras from multiple instances (one camera per instance). This document presents a summary of how to set up systems for multi-camera applications in the following scenarios.

- Dual camera - sequential use.
- Dual camera - simultaneous use.
- Adding a third camera in these cases.

Recent developments in multi-core processors and fast hard drives means that a single high performance works station can provide the necessary bandwidth for simultaneous multi-camera acquisition, where in the past multiple workstations were required. Current generation iQ workstations have the capabilities needed to support multi-camera acquisition and with a dual disk RAID0 configuration, the disk bandwidth is more than sufficient.

4.7.1 Dual camera Sequential operation

IN this mode of operation, iQ can load more than one camera inot a single instance and use them sequentially. The nD Protocol Tree has a “Camera Selection” keyword which allows the user to specify which camera is going to be used for the acquisition. Camera Selection functions in both FLZ and Time Lapse, but note that in FLZ both cameras must be triggered from PCU (or BOB) D07. Failure to make the connection between PCU (or BOB) D07 and the Camera Ext Trig input will result in a Timeout message as shown right.



4.7.1.1 Camera Selection in Sequential Mode

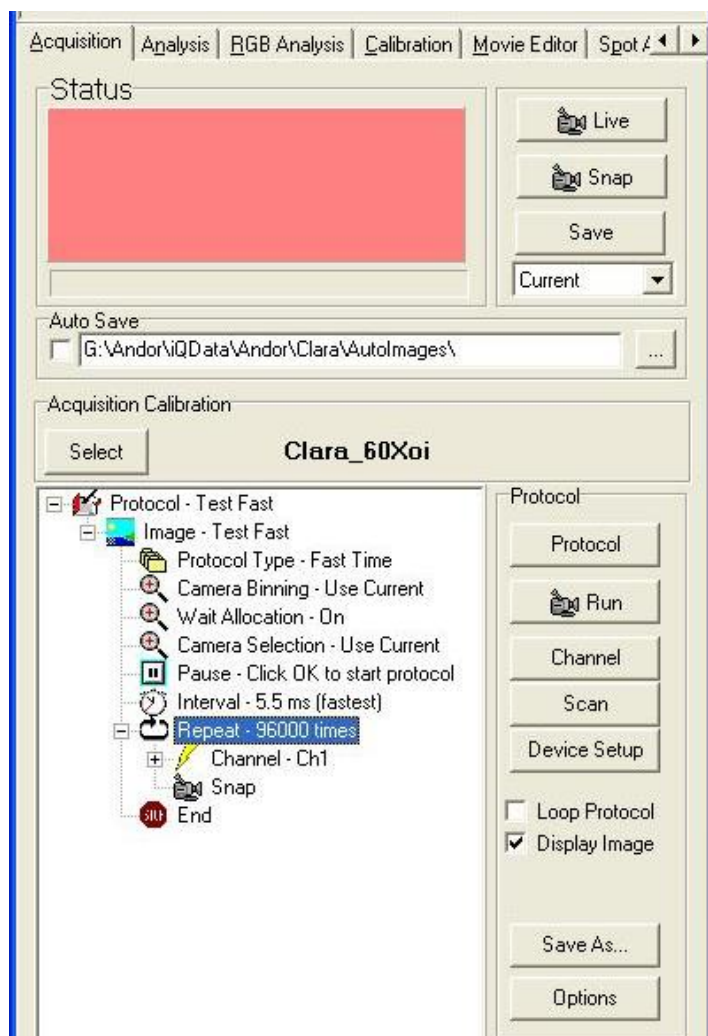

The Camera Selection keyword defaults to “Current” as shown here, but a right click Edit on the item will show a list of cameras which are loaded in iQ and allow you to choose one for the current Protocol.

When more than one camera is loaded, the Device Setup tab shows a new tab, Camera Selection, in which the loaded cameras are listed. Using the controls on this The user can Edit the Alias (user defined name) and the colour of the Image Window background as a visual cue to remind you which camera is loaded. The Device

Setup Camera tab is shown over the page with the Camera Selection tab.

4.7.1.2 Load Protocol and Camera Selection

To switch between cameras under Protocol control, you can set “Protocol1” to use “Camera1” and set “Protocol2” to use “Camera2”. And when you want to run the two sequentially add the “Load Protocol” action at the end of Protocol 1 and you can apply the same approach to use multiple protocols as well, each loading the next. In this way you can switch operations between different imaging modes with different cameras on different microscope ports - a powerful mode of operation.

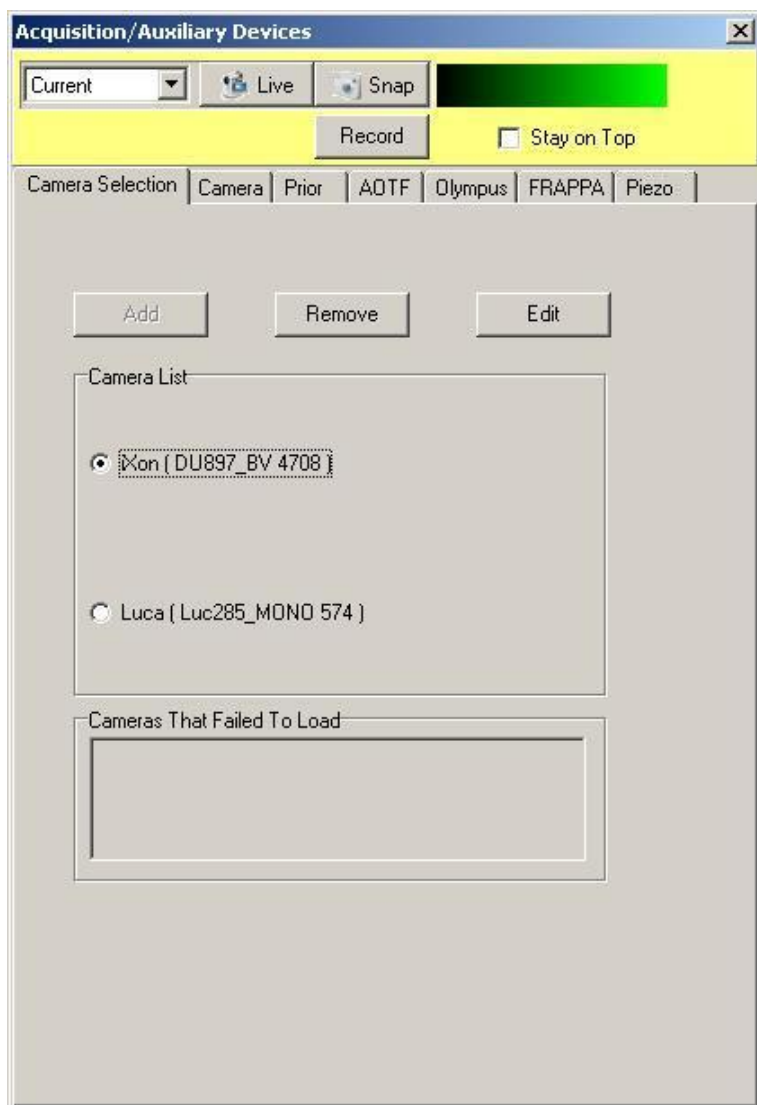

This screen shot shows the Camera Selection tab in the Device Setup Dialog. This allows you to choose the Current camera, edit the name of the camera and change the Image Window background color as a visual cue or reminder of the selected camera.

4.7.2 Dual camera simultaneous operation

We assume here that the relevant hardware has been installed in the PC. In this example we illustrate the use of two identical cameras, iXon DUV-897BV-E. The screen shots shown here were taken from a system running the cameras with CCI-23 (PCI) and CCI-24 (PCI-e) controller cards. We want to perform FLZ operation for best performance, so we need either an Andor low cost break out box (BoB) or Andor PCU for device control.

4.7.2.1 Creating the Configurations

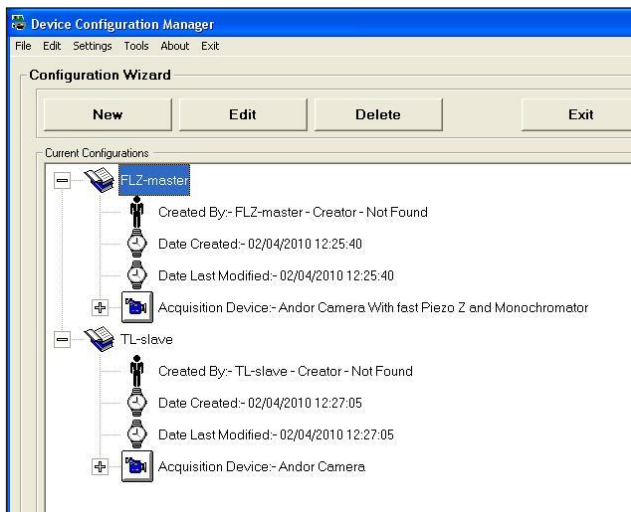

Open the Configuration Manager supplied with iQ (1.10.2 or later) and create two configurations, one FLZ which will be used for the so-called **Master** instance, which generates the trigger signals from the PCU (or BoB) and a second for the **Slave** instance, in the Time-Lapse mode as shown in the screen shot below.

Make sure that the Global settings are configured as shown below so that the **ImageDisk** uses a suitably fast hard drive for streaming. In this example a pair of high performance 1GB 7200 rpm SATA disk drives configured in RAID0 mode were

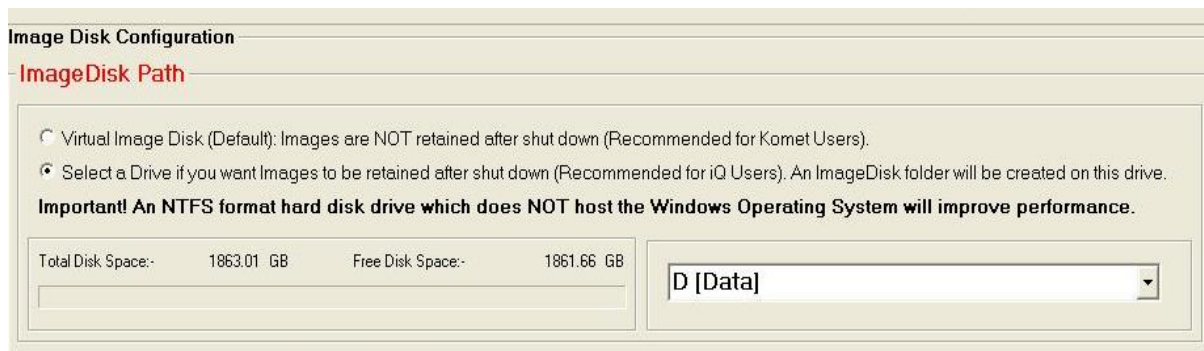

selected as drive D (Data) as shown below.

4.7.2.2 Starting two instances of iQ

When you have the optical setup configured then you will need to choose which camera will be loaded by the Master configuration i.e. FLZ. We refer to FLZ as the Master instance because it is FLZ that controls the wavelength, Z and trigger sequence of the cameras. The choice is arbitrary, but iQ will remember for FLZ sessions. Start iQ, select the FLZ configuration and then the dialog below will be shown.



The camera selected using the drop down list and is identified by serial number – which is printed on the camera body for physical identification – in this case the SN is printed as X3877. Note is associated with configuration FLZ-master, which we created in the previous

section. When you click on OK, iQ starts and loads the camera in FLZ mode and connects to the PCU (or BoB) and any other hardware you specified. We will configure this instance of iQ in the next section.



Now start another instance of iQ and select the TL-Slave configuration. When you do another camera selection dialog is shown. Select the second camera to be use for simultaneous acquisition.

You will now have two instances of iQ open and you screen will look something like this, where we have Master on the left and Slave on the right. One large (24” or greater) or two medium size (22”) high resolution monitor(s) suit this application best.

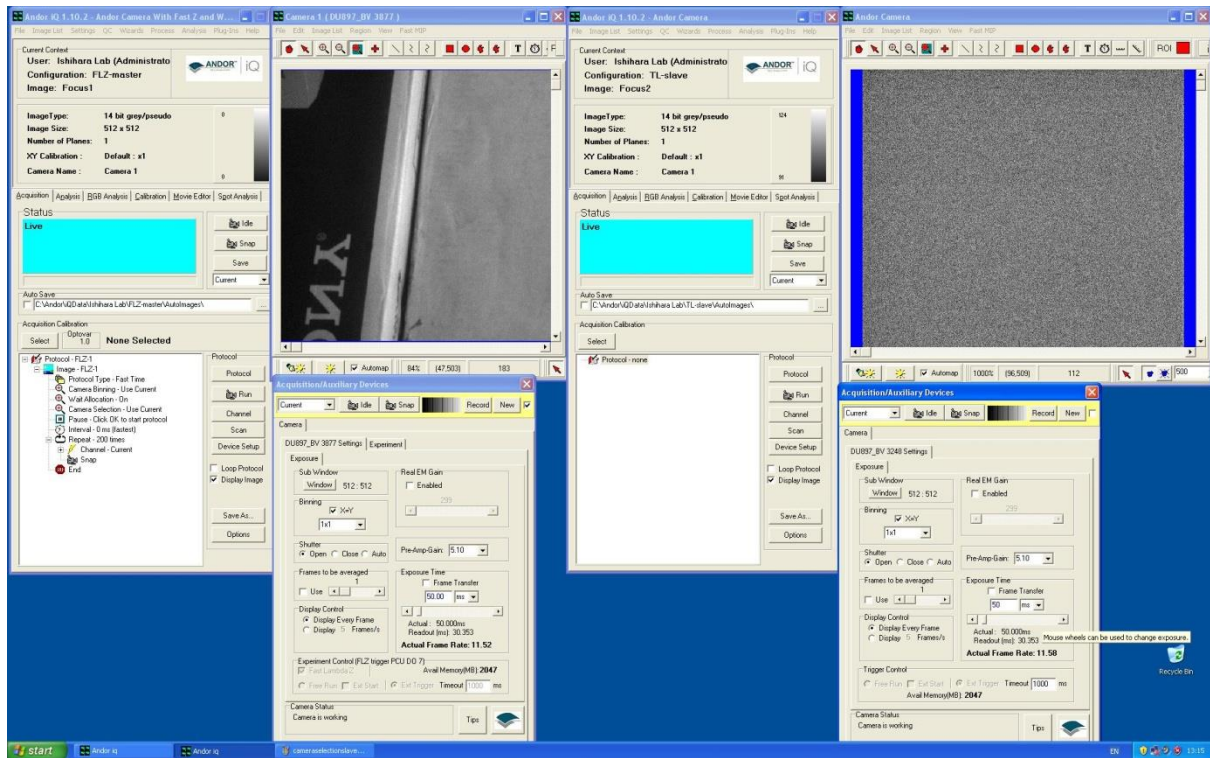

4.7.2.3 Setting Up FLZ Devices and Sequence

To setup up the two instances of iQ, you can run the Master in either Time Lapse or FLZ mode, but the Slave must be run in Time Lapse camera only mode, because we do not want it to try to control hardware the hardware like the Master. Before you set the Master into FLZ mode to make sure that the FLZ devices are connected.

You can now proceed as explained in the FLZ section to configure the hardware and setup the Sequence tab for the desired acquisition sequence.

When you have the above devices selected, you will have controls enabled in the Sequence tab as shown below and the properties will reflect the device settings from the Wavelength and Z tabs.

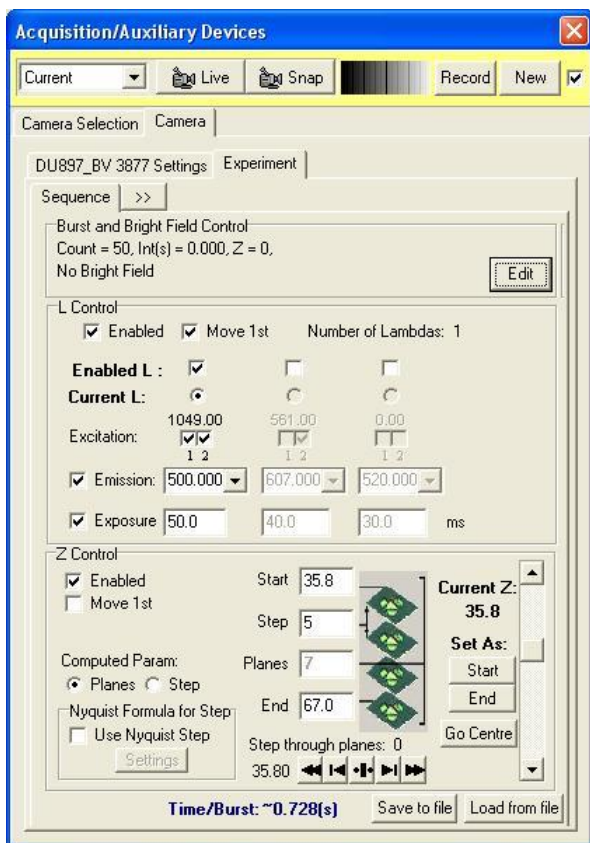

Note that in this case we have selected simultaneous excitation with wavelengths 488 and 561 (two checks clicked) and the number above is set to the sum of wavelengths (1049) as a further indication. This example is shown because dual acquisition may require simultaneous excitation of two fluorophores for emission splitting devices.

Note that a Z scan has been specified here and the “Burst and Brightfield Control” settings at the top of the dialog now have different values from the previous Sequence tab illustration above.

We will deal with this point later when we discuss matching Master and Slave frame count during acquisition. Now you should be able to go Live and obtain an image from a test specimen if the system is setup correctly.

4.7.2.4 Setting Up the FLZ Protocol

First create a Protocol in the Protocol Manager by clicking on New and choose the Fast option as shown since you want to execute in FLZ mode.



When you click OK the prototype FLZ Protocol shown on the next page will be created.

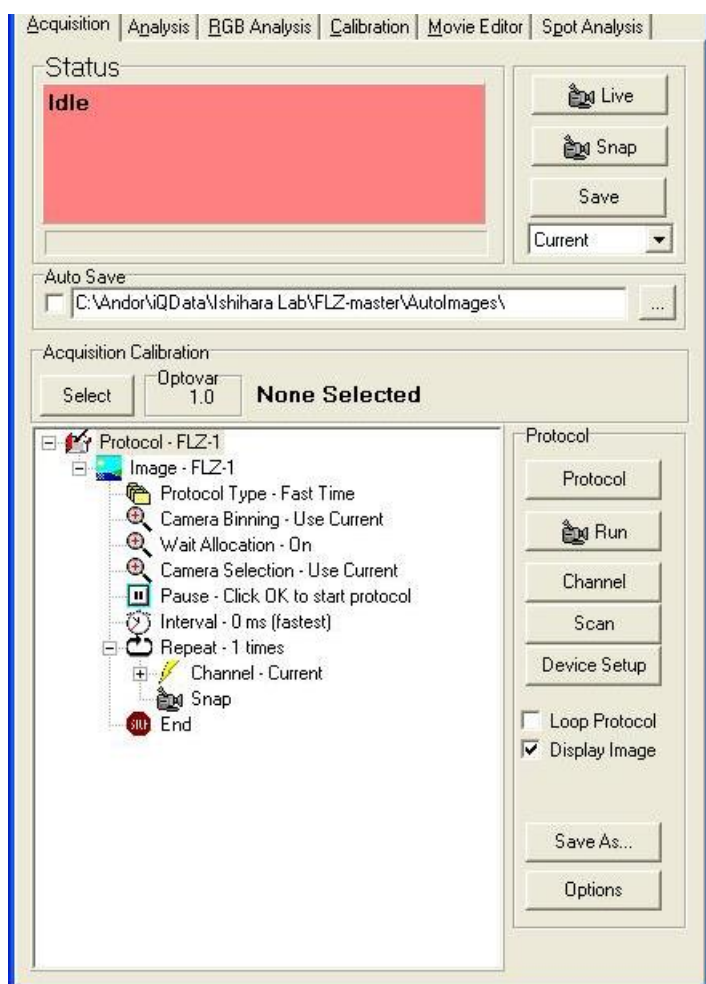

You can now edit it the Protocol to change the Channel from “Current”, number of Repeats and Interval, Pause message etc. as described elsewhere in the manual.

4.7.2.5 Setting Up the Time Lapse

The Time Lapse Protocol needs to be a simple Fast Time Lapse setup with a single channel. Note that the cameras settings for readout and exposure need to match or be faster than those of the Master, otherwise the Slave will miss trigger signals from the Master and drop frames.

The other thing you must make sure of is that the number of frames to be captured by the Slave is equal to the number captured by the Master. You can compute the number of Master FLZ frames, N_m as follows:

$$N_m = N_p * N_b * Ch * Z_s$$

Where N_p is the number of Repeats in the Protocol, N_b is the number of Bursts in the FLZ Burst setting, Ch is the number of Channels in the FLZ L setting and Z_s is

the number of Z steps in the FLZ scan.

4.7.2.6 Notes and Cases where synchronization may fail.

1. The Slave must be set to Ext Trigger mode and it should be triggered from either the Master Fire pulse or from the PCU or BoB D07 signal. If you fail to make the D07 connection , iQ will eventually Timeout while waiting for a trigger signal and show the following dialog.

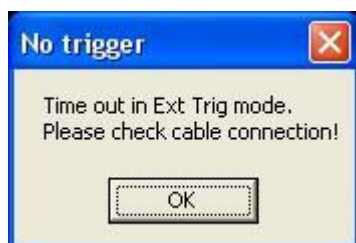

2. There are some circumstances where FLZ resynchronizes and “dumps” frames, especially in Frame Transfer mode and with Bright field capture (Burst settings) where the Slave will lose synchronization because it has no knowledge that frames are not valid. Thus the Dual camera mode is aimed at fast acquisition where the two cameras are operating with a wavelength or polarization splitter or from two different modalities. Provided that the FLZ mode is not in FT mode or using Bright field, then the cameras should remain synchronized.

4.8 Precision Control Unit (PCU), Triggers and Events

See **Appendix 3.3** for information on installing and setting up DIO and DAC cards.

4.8.1 PCU Box with Digital I/O

Triggers can be inserted into IQ protocols in two forms: Trigger IN and Trigger OUT.

Trigger IN can be used to start image acquisition or synchronize the protocol via an external source and also to signal an external event and generate an event marker in the image series. Trigger OUT can be used to activate external instruments and devices.

4.8.2 Andor PCU with Digital I/O and DAC Boards

In addition to those functions above, DAC has the added facility to control additional shutters and a Monochromator for specific wavelength changes during an experiment.

To simplify connection and protect your system from external catastrophe e.g. voltage overloads or damage, we have designed the PCU illustrated on the next page.

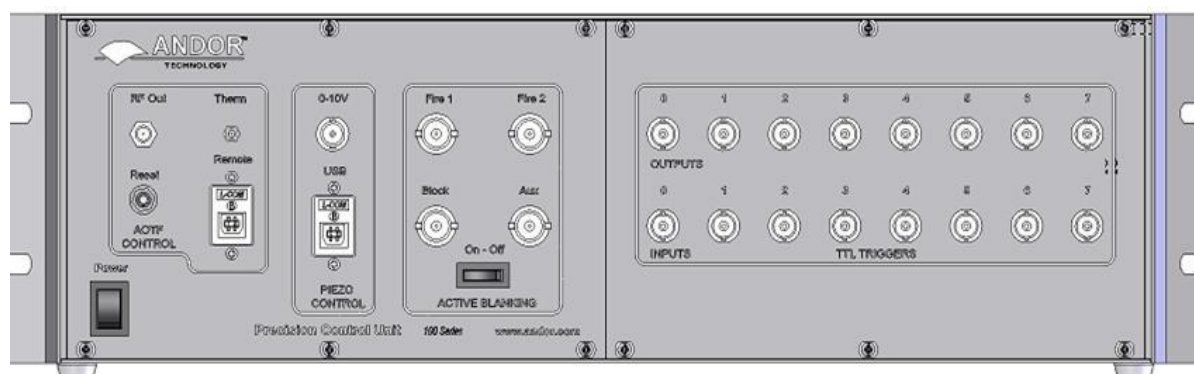

The **Andor PCU** is an opto-isolated connectivity device to allow interface between external TTL signals and Andor iQ. The PCU box system provides a simple means of delivering TTL inputs and outputs to and from iQ. The system includes a PCI Digital

(and optionally DAC) I/O card, connecting cable and free-standing or 19" rack-mounted enclosure, housing power supply and opto-isolators, with 8 input and 8 output BNC connectors for convenient coupling to other apparatus. PCU provides a means of control and synchronization with external apparatus. It will be especially useful for those wishing to synchronize with electro-physiology equipment, micro-injectors, flash lamps and other illumination control. In addition, the PCU box will allow coupling to third party apparatus that accept external TTL inputs to initiate actions.

The protocol described here is a physiological live cell experiment using neuronal cells. It involves an initial period of depolarization of the cell and subsequent monitoring of intracellular calcium levels in response to stimulation with a calcium agonist e.g. acetylcholine. The indicator used is the ratiometric calcium indicator Fura-2.

In this example, IQ is set up as follows; two protocols are created for the calcium indicator Fura-2, which will be run sequentially by inserting a **Load Protocol** command ([Section 4.6](#)) at the end of the first protocol (named Fura pre-drug).

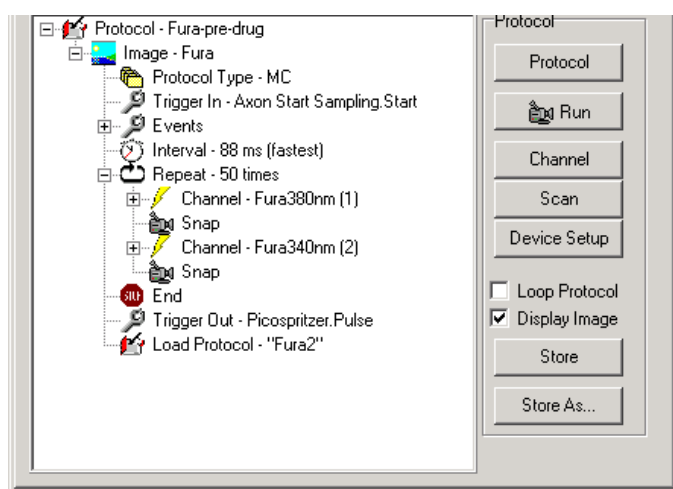

This first protocol, shown left, has a Trigger IN inserted at the beginning of the protocol. This means the acquisition will be started by a change in signal level as the Axon polarization device activates the trigger, when it applies a polarization current to the cell. The protocol will run for the designated number of frames until the Trigger

OUT at the end of the protocol activates a Picospritzer system to inject a pulse of calcium agonist into the cell.

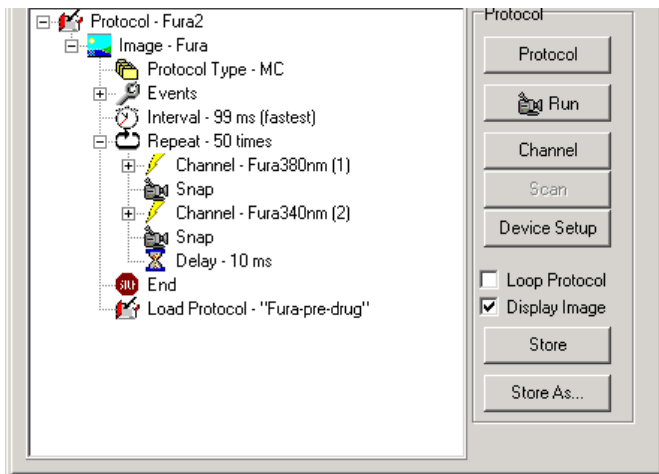

Following this injection event, IQ will load the second protocol (named Fura 2) which will run for a set duration monitoring changes of intracellular calcium levels within the cell. At the end of this sequence Fura-pre-drug will be loaded and the protocols pair will run recursively until the user terminates the

sequence.

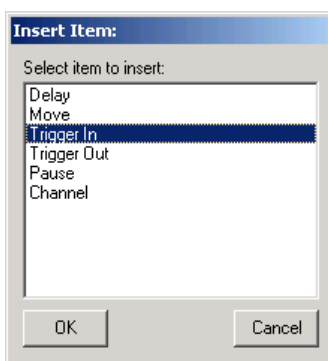

To set up triggers in the protocol, right mouse click on the place you wish to insert the trigger and from the pop up menu, select **Insert**, then **Trigger IN** or **Trigger OUT**. The Trigger will be inserted immediately after the selected event.

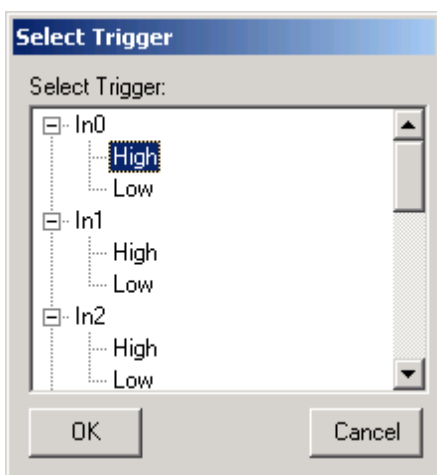

On selecting Trigger In, the box shown left will appear. Select the trigger input line in this case input 0 (In0). Select whether the event will be triggered by the line in a high or low state.

The set up is identical for an output trigger. You may wish to put more meaningful/descriptive text labels associated with the Trigger lines. This can be done through the Trigger setup panel. Note that restricted users will not be able to change the settings, but other users will.

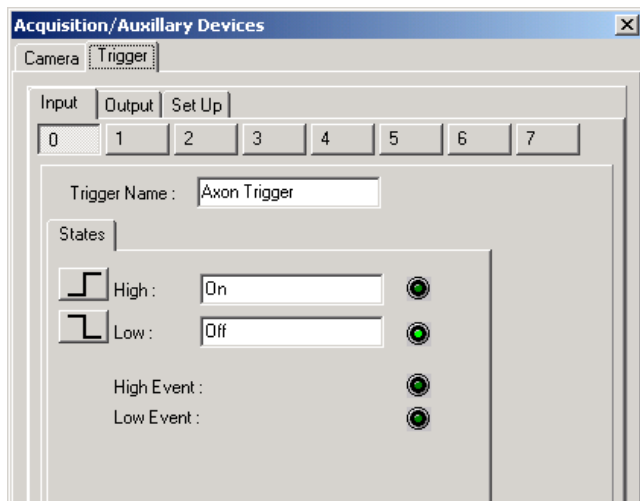

The Trigger setup panel is available through the Device Setup dialog, accessed by clicking the Device Setup button. To make changes to the panels you must click the Lock/Unlock button at the bottom right of the panel.

Then the Input/Output lines are selected from the tabs. Here a Trigger IN (Input 0) has been selected to start acquisition in response to a signal from the Axon trigger device. To make this clear the Trigger name has been set to “Axon Trigger”. Any or all of the IO lines can be used (0-7) and labeled in this way. The state or transition of the input line can be set here also. The States High and Low have been labeled On and Off, for clarity. Once you have set these up as desired, click on the Lock button to fix the settings. When the Insert Trigger IN dialogs show next time, the lines will show their newly labeled states, both in the nD Protocol Tree and the dialogs. If you change labels in the Trigger Setup panel, you must revise Edit the Trigger entries in the nD Protocol Tree, since they will not be automatically updated and will fail to be

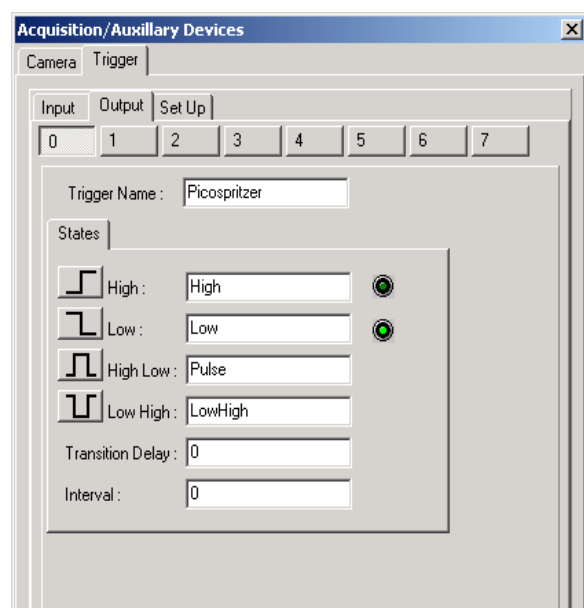

matched with the original entries.

The Trigger OUT setup is accessed in the same way and edited similarly. In this example the signal will be used to activate a Picospritzer injection device, which will apply a pulse of agonist to the cells under study.

Output Line 0 has been selected, and the line state, HIGH-LOW, has been renamed to Pulse. This will deliver a pulse as

shown; the duration is set by typing a value into the interval box (this value is the pulse duration in ms).

4.8.3 Using Events and Markers

The Events command is inserted into an IQ protocol by default. To adjust the way the Events will be used, you simply Right mouse on the Event command in the Protocol and Edit. Events will create markers in the Image at the time point when

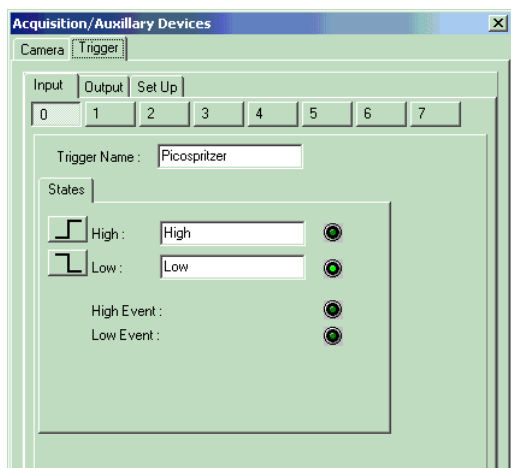

they occur and these markers will be available for viewing in analysis and image navigation. By default the keyboard Spacebar is used as the manual event input. But you can also introduce events from external sources via the Trigger interface. The text label associated with the selected Trigger input will be used as the description field for each event it creates.

Before editing the Event Command, make sure the Trigger device is setup, (as described in the **Section 4.2.4**) with the appropriate text labels to ease Event interpretation at a later date. See the panel on the left.

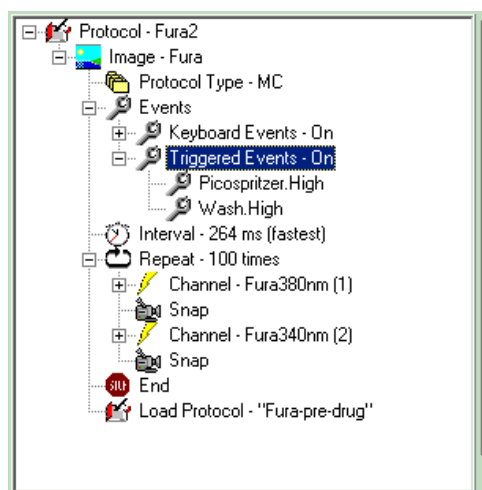

To configure the events, a Protocol is setup as normal and then the Events command edited as shown here. Access the Edit Events panel by Right Clicking on the Events command in the Tree.

When you Edit the Protocol, the dialog shown here will be displayed and you can choose to switch on and off the keyboard events and select the Externally Triggered Events by name.

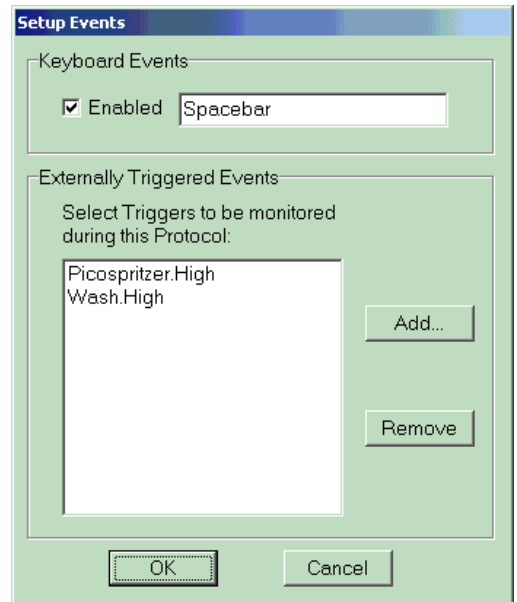
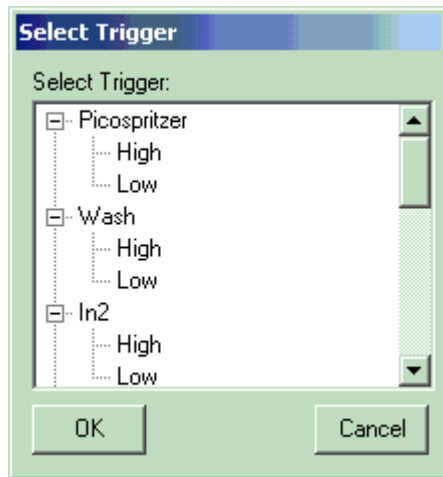

Clicking the Add button shows the Trigger select dialog (left), from which you can choose the input(s) and states that will generate an Event.

As the Protocol Executes the Status box indicates how many frames have been acquired from the sequence and among other information, the number of Events will be displayed as shown here.

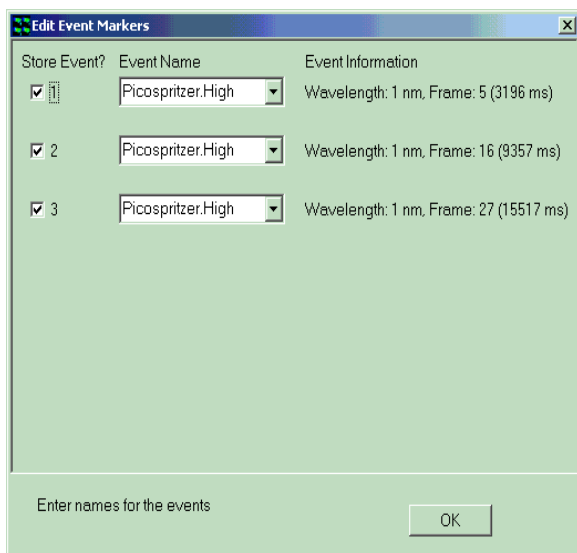
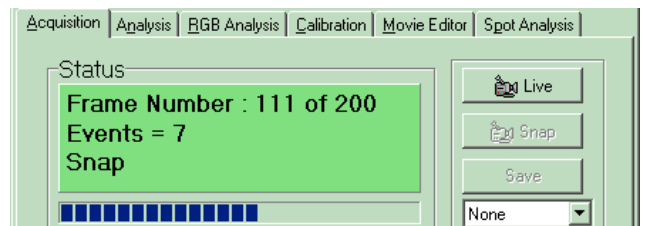

When the Protocol has completed or stopped an Edit Event dialog is shown, which allows you to edit the text associated with the Events. This is especially useful when you are using only the Spacebar for events and you need to differentiate. Editing immediately after the measurement will make sure your records are accurate.

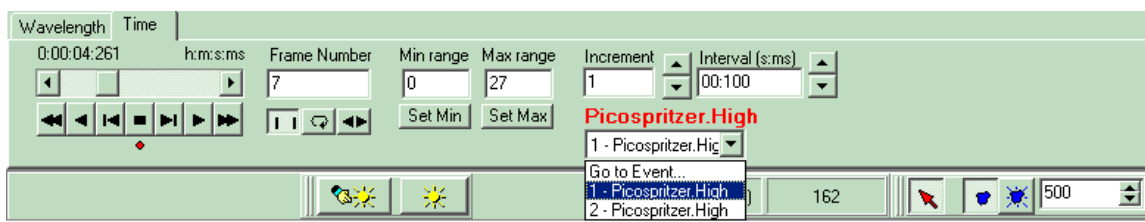

When an image with Events is reviewed, Navigator is shown. You can see immediately how many events were created by the Events dropdown list box. You can move to the frame where any event occurred by selecting the Event in the list, as shown. As you navigate through the image, a text field is shown above the dropdown list as you pass each Event.

When you use the Analysis tab to perform through-series analysis, then the Markers or Events are shown on the data plot and you can also choose to show the Event labels. This is illustrated over.

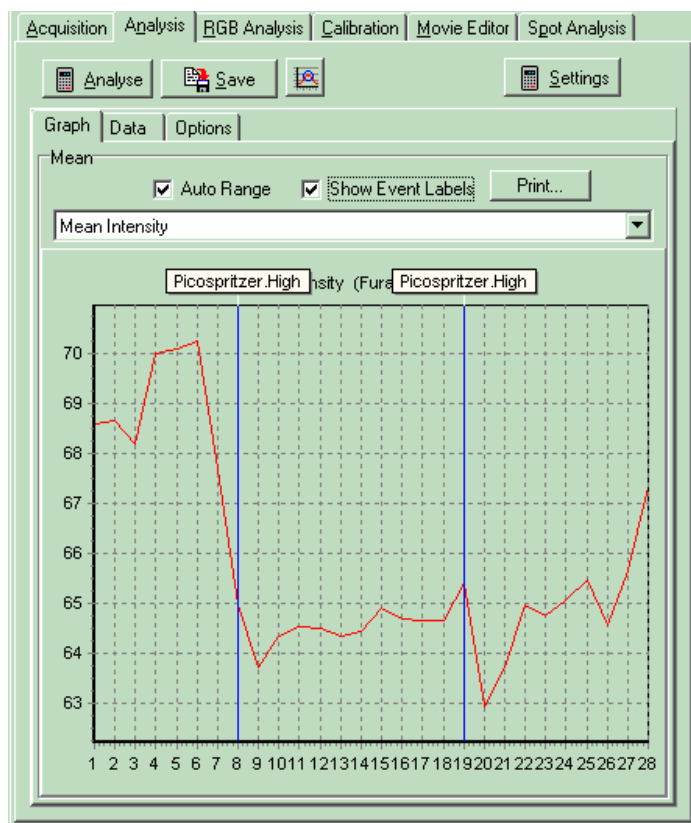

The analysis plot can be printed and will appear as it does in this dialog.

4.8.4 Using the On-Line Chart

The On-Line Chart allows you to monitor intensity in multiple ROIs as the protocol proceeds and images are acquired. To insert an On-line Chart you right click on the nD Protocol Tree on the last Snap command and Select from the Insert dialog (right). Note that you cannot use the On-line Chart in a Fast Time (Tempus mode) Protocol.

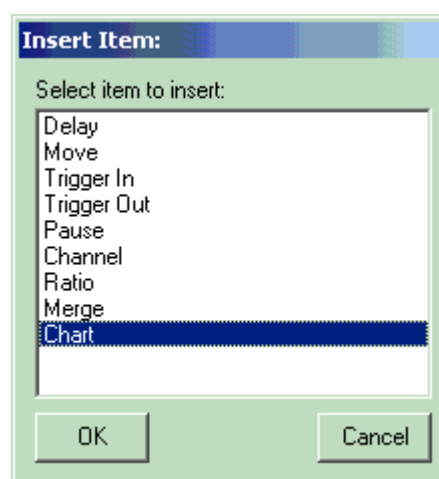

Andor iQ USER GUIDE

The On-line Chart can be used to monitor the intensity in one channel, selected from the setup dialog shown below or the Ratio between two channels in a multi-channel Protocol.

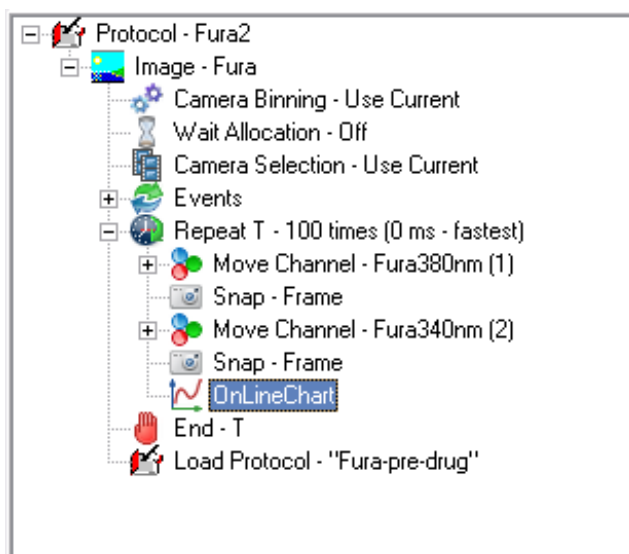

The On-line Chart will be inserted below the Snap command as shown in the Fura ratio protocol left. Each time a frame or frame pair is acquired the On-line Chart will be updated.

If you need to modify the settings of the On-line Chart, right-click the node in the tree and select **Edit** to display the Chart Options window. Once you

have modified the settings, close the window. The settings will be saved with the protocol.

Note: Updating the options of the Chart Image plug-in (available from the View menu) has no impact on the On-line Chart settings.

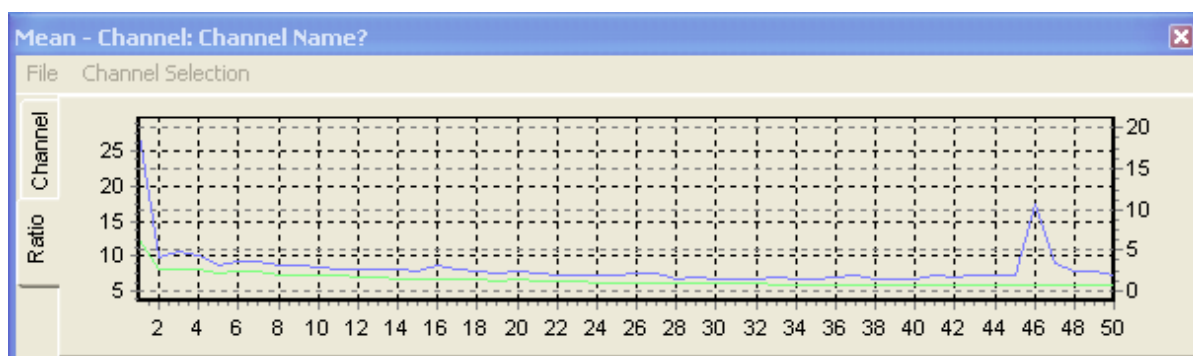

This plot can also be printed from the File Menu. The On-line Chart Window can be resized and placed conveniently to avoid visual clutter. A favorite location is below the Image Window, and made fairly small in height. The On-line Chart will remember its size and position throughout the current session.



5 - Analysis + Visualization

5.1 Image Contrast and LUTs

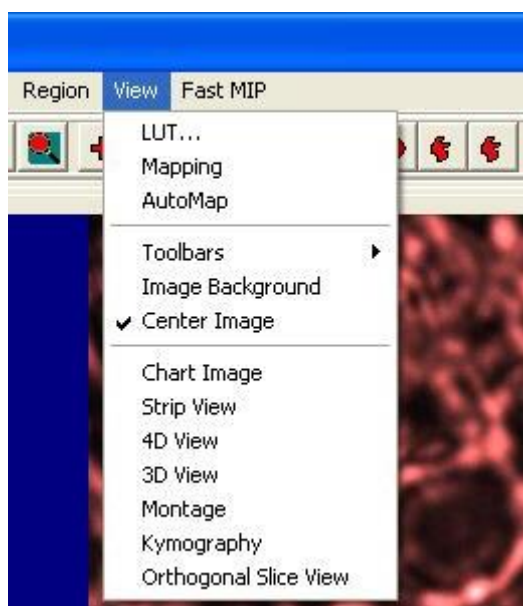

Selecting the **View** menu item provides the necessary tools for the adjustment of image contrast and brightness and selection of look up tables (LUTs).

5.1.1 LUT Control and Creation



The LUT function is accessed from the View menu as described above. Clicking the right mouse button while the cursor is on the Channel Icon below the image will also open up a pop-up menu with three entries: **LUT**, **Mapping** and **Auto-Map**. Mapping opens up the Image Contrast Dialogue as described above. The Auto-Map option has the same functionality as the **Automap** button discussed above. **LUT** opens up a selection of pre-defined Palettes or **Look Up Tables (LUTs)**, some of which are listed below:

Grey – In the Grey level Palette each image pixel grey value is represented by equal weights of red, green and blue components. Thus, **black** (grey level 0) has 0, 0, 0. **White** (grey level 255) has 255,255,255. This is a standard method of visualizing monochrome images.

Negative - The inverse of grey Palette, where black appears white and vice-versa. Obtained by the "1's complement" of image grey levels.

Camera - An input Palette from a camera, where intensity is proportional to the video

signal level, i.e. this is a normal grey scale. However, grey level zero (black) is set to RED=255, B=G=0, while grey level 255 (white) is set to GREEN=255, R=B=0). Use this Palette when setting up imaging conditions to detect when saturation occurs.

Red - This is a monochrome palette using only the Red color component (intensity 255 - the maximum color brightness). This provides an image shown in a manner that may be reminiscent of viewing a fluorescent image with the appropriate fluorochrome.

Green - This is a monochrome palette using only the Green color component (intensity 255 - the maximum color brightness). This provides an image shown in a manner that may be reminiscent of viewing a fluorescent image with the appropriate fluorochrome.

Blue - This is a monochrome palette using only the Blue color component (intensity 255 - the maximum color brightness). This provides an image shown in a manner that may be reminiscent of viewing a fluorescent image with the appropriate fluorochrome.

Bandit - A color-banded Palette, ("the banded one") in which groups of 16 grey levels are visualized as the same color. This is useful for pseudo-coloring and for visualizing and enhancing structural and intensity variation in images. This is valuable for comparing changes to the image after a processing operation.

Furnace - This Palette is a yellow-brown table in which intensity is matched to brightness along the yellow-brown color scale. Furnace provides enhancement to the visibility of low contrast image structure.

If none of the above palettes are selected the default palette is used.

At the bottom of the LUT list, there are three options available: **Load**, **Edit** and **Save**. The user can load a previously defined LUT by selecting the **Load** option. This will

open up an Open File Dialog and the user can select the LUT files they want. When **Edit** is selected, an Edit LUT Dialog is displayed from which the user can modify the current LUT by adjusting the graphic presentations of its Red, Green and Blue components.

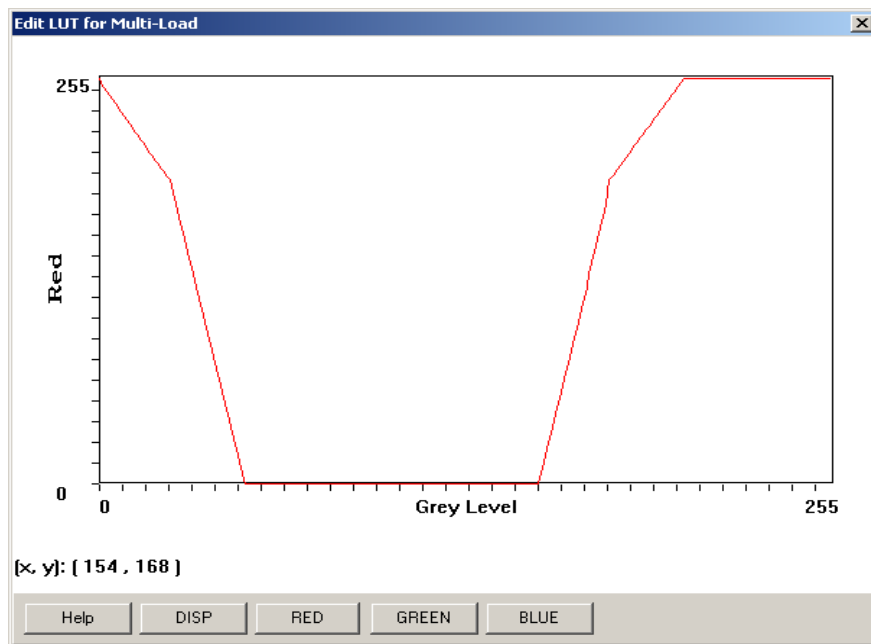

The modified LUT can be saved as a new one if **Save** is selected later. The LUT pop-up list will show add user-defined LUTs to its List once they have been saved. Another way of creating new LUTs is from a text file based exactly on the format of the LUT file. The LUT file format is illustrated over.

Andor iQ USER GUIDE

FORMAT of LUT FILE:

[Description]

ASCII LUT File=TRUE

[Red Green Blue]

000=000 000 000

001=000 001 000

002=000 002 000

003=000 003 000

004=000 004 000

005=000 005 000

006=000 006 000

007=000 007 000

008=000 008 000

009=000 009 000

.....

250=000 250 000

251=000 251 000

252=000 252 000

253=000 253 000

254=000 254 000

255=000 255 000

You can create this in Notepad or you favorite editor and then save the file to the LUT folder, which can be found here: **C:\Documents and Settings\All Users\Application Data\Kinetic Imaging\Configuration\LUT**

5.1.2 Image Contrast Control

The Mapping and Automap options have the same functionality as the **Mapping** and **Automap** buttons described previously in **Section 2.8.1**.

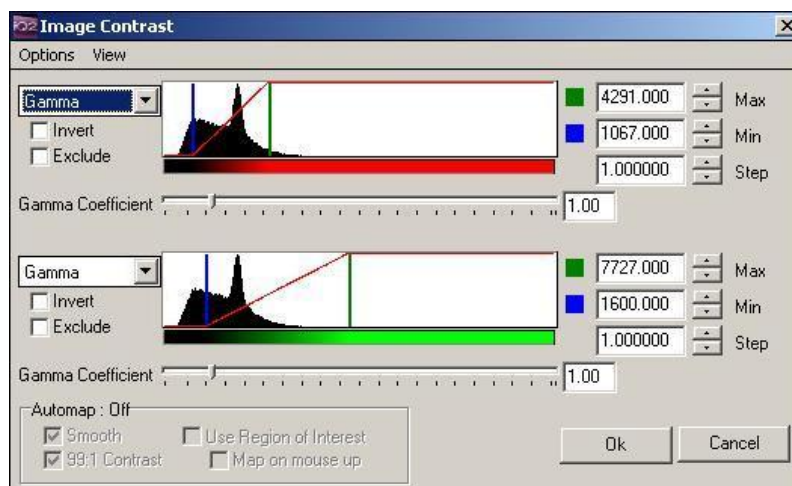

Selecting the **Mapping** menu item displays the dialogue illustrated above.

To **invert** the mapping (flip contrast) check the Invert option.

The scale of the mapping mode can exclude certain areas if the **Exclude** checkbox is enabled.

Selecting “View->**Log Scale Histogram**” transforms the histogram Y axis to a logarithmic scale, emphasizing the low frequencies

Selecting “View->**Zoom To Map**” scales the histogram X axis around the Min-Max values, as shown opposite.

From the drop down list below the Mapping Range scrollbars, you can select the required mapping mode (e.g. Gamma, Square, Square Root, Sine, Cosine, Log e, Log 10, Exp e, Exp 10 and Linear). The diagram below illustrates the various mapping modes that are available.

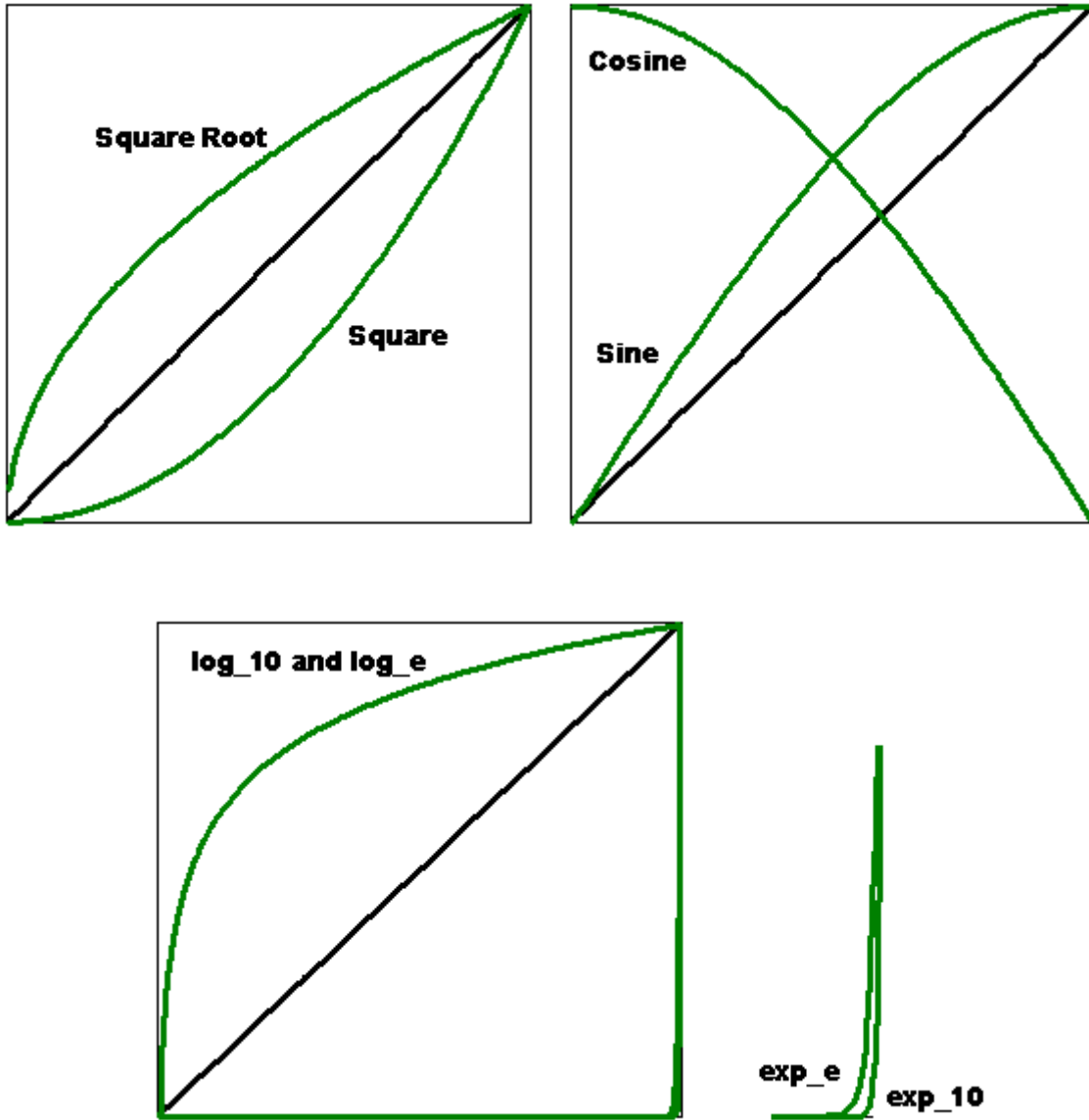

Gamma is the default mapping and generates a mapping of the form, X^{Gamma} , where *Gamma* has the range 0.1 to 8.0. This gives the user ultimate flexibility in enhancing images. Gamma = 1 is linear, 0.5 is square root and 2.0 is square. Users can control the gamma coefficient value using the slider or the text box.

5.2 The Online Graph

The Chart Image is accessed from the View menu on the Image Window. It will display intensity changes and/or ratios in the Image Window both during Live and playback of previously captured data but not during protocol run. (To allow Chart to be displayed during an experiment insert an OnLineChart node in the nD protocol tree as described in **Section 4.8.4.**) In short, anything happening in the Image Window will be displayed by Chart Image. It can use both data from ROIs or the whole image.

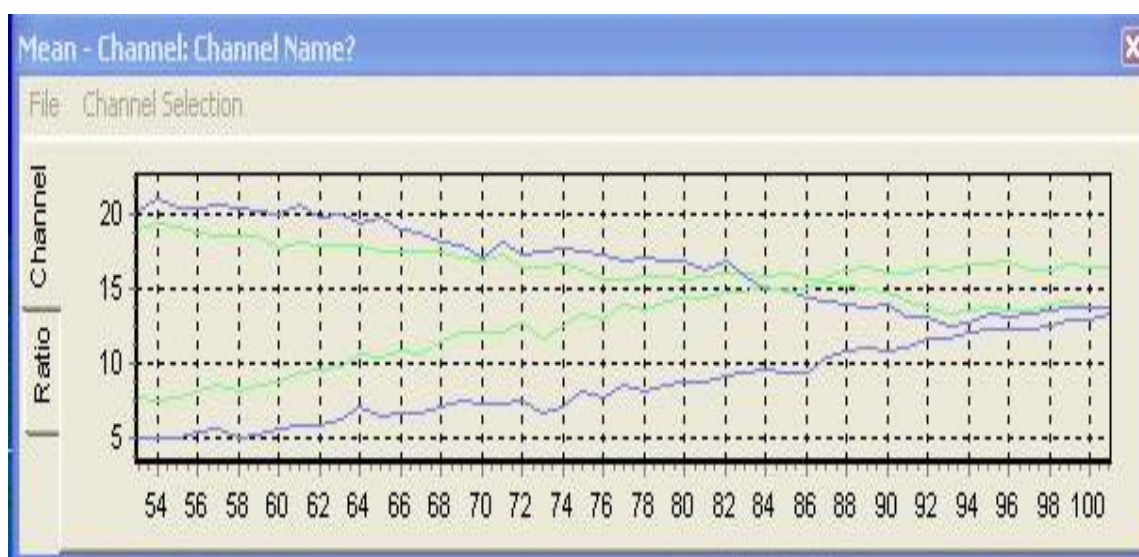

The File menu has two options: **Print** and **Close**. The charted data can be printed for further inspection and evaluation using the **Print** button.

Select the **Close** button to exit from the On-Line Chart window.

The **Channel Selection Menu** opens the Chart Options.

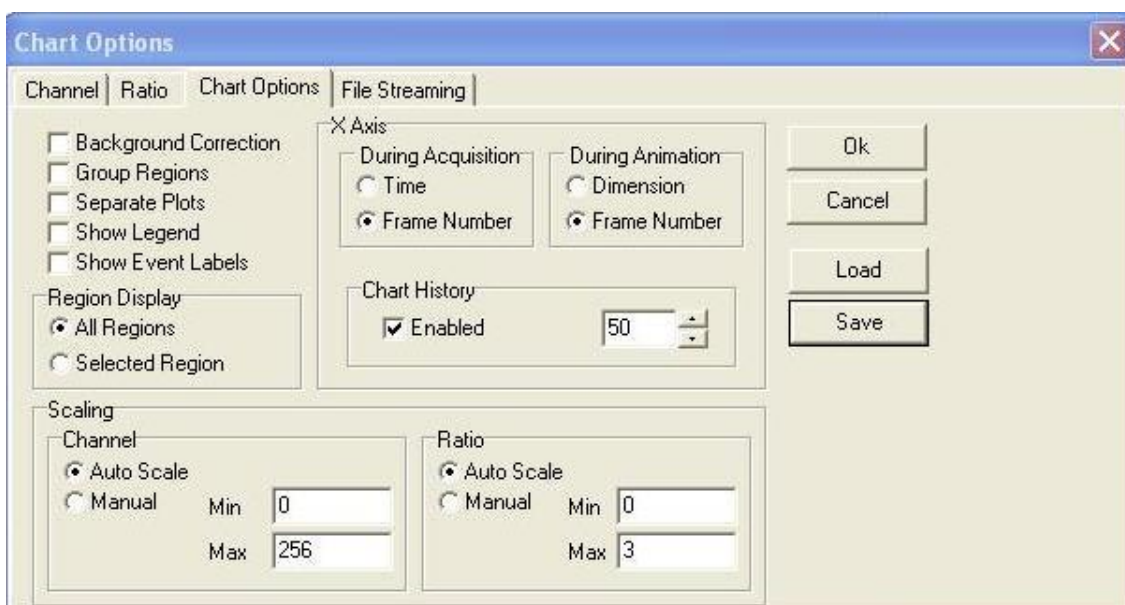

The charted data can be presented in various formats dependent on the settings specified in the **Chart Options Tab** and whether user defined ROI's have been drawn in the image. A discussion of IQ Analysis features in conjunction with the use of regions of interest is described in **Section 5.5.3**.

5.3 Through-Series Analysis

The Analysis Tab opens the Analysis Window, which is used to calculate statistics for the image, or for user-defined regions on the image. The results are displayed both graphically and in numerical form.

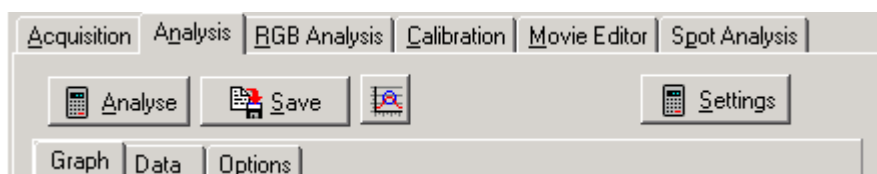

5.3.1 The Graph Page

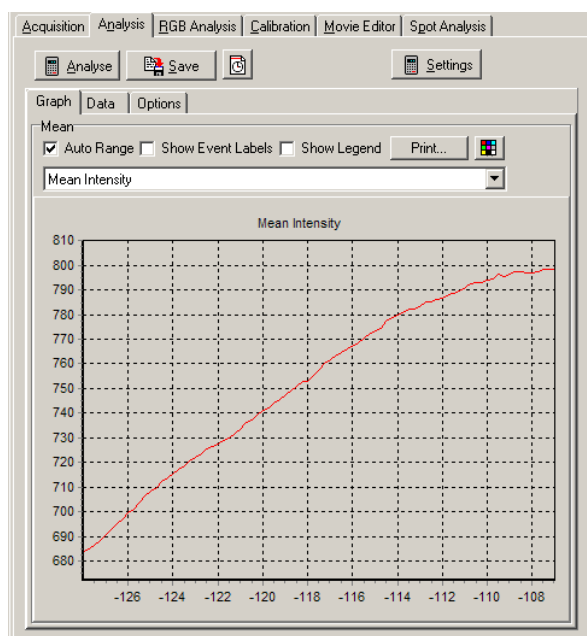

If regions have been defined on the current image, using the Rectangle, Ellipse, Polygon and/or Freehand Polygon buttons in the Image Toolbar, statistics can be calculated on each region for each time frame. The statistics to be calculated are selected on the Options page. The calculated plots are drawn on the Graph page, while the calculated statistics are displayed on the Data page.

Pressing the **Analyse** button will perform the analysis.

Note: If no Regions of Interest have been defined, the analysis is calculated for the entire image.

Once an analysis has been performed, pressing the **Save** button will open a save dialogue window, allowing the user to specify a directory and file name to which to save the data.

Note: If **Automatic Directory Selection** is selected on the Options page, the default folder to which the data will be saved is:

C:\AndorBio-imaging\iQData\User

Where User is the User Name specified on starting iQ

Note: Even if **Automatic Directory Selection** is selected, it is possible to select a different folder to which to save your data.

The data is saved in tab-delimited format, and can therefore be opened in Spreadsheet packages such as Microsoft Excel.

The x-axis coordinates of the Analysis graph can be selected using the button to the left of the Threshold Toolbar.

Click on the button to toggle between:



.....Frame number



.....Time

Pressing the **Settings** button opens a dialogue in which you can specify what intensities to consider.

Note: In order to access the Settings button, the **Threshold** option must be ticked in the Options tab.

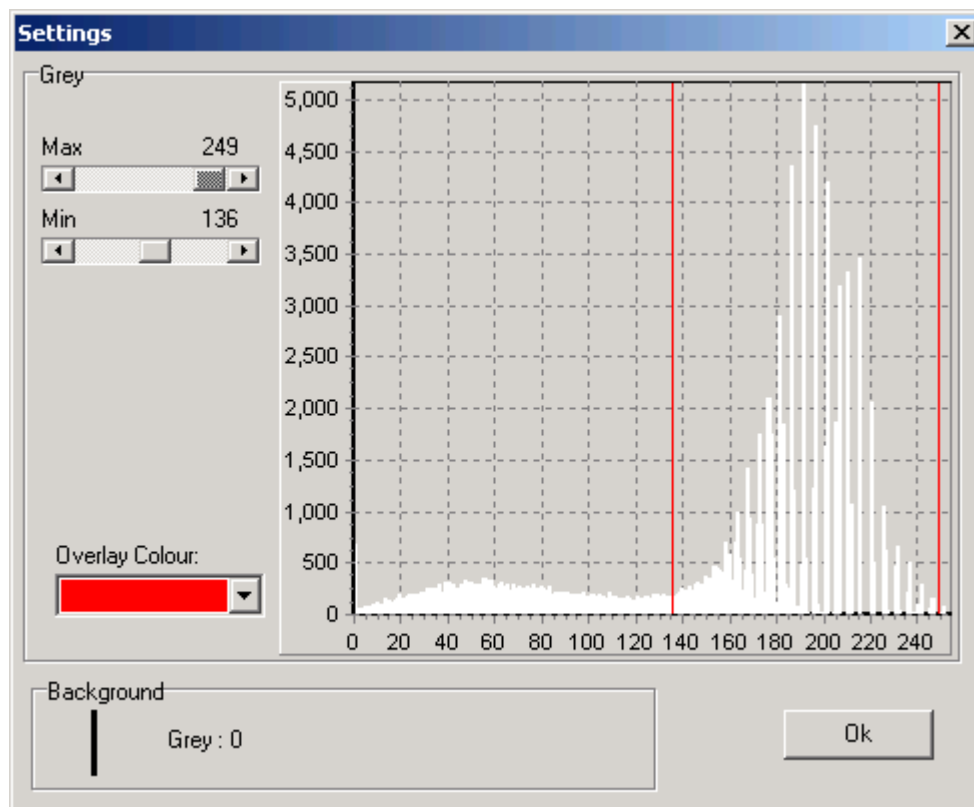

Use the **Max** and **Min** scrollbars to specify the minimum and maximum pixel intensity values that will be considered.

The specified limits are displayed in the graphs, and the image displayed in the Image Window is updated, such that pixels included in the selected range are colored red, thus enabling interactive optimization.

When the parameters in the Settings dialogue have been optimized, press **OK** to close the dialogue, accepting the specified values.

Pressing the **Settings** button for a color image throws up the following message:

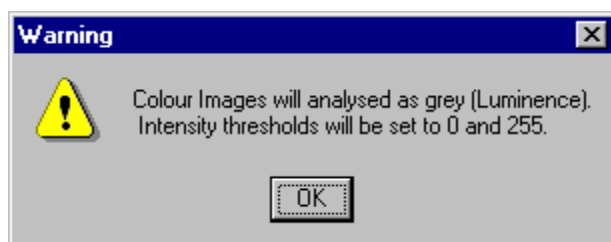

This means that a color (RGB) image will be analyzed as a grey (luminance) image. The red, green and blue components of the image will each be given a weighting, by multiplying the pixel intensities by the following values:

Red 0.299

Green 0.587

Blue 0.114

The minimum pixel intensity value will be set to 0, the maximum pixel intensity value to 255.

The data calculated from the analysis is displayed in graphical form. The data for each Region Of Interest is represented by a single line, the lines being color coded for clarity.

To zoom in on (magnify) features on the graph, drag out a region with the mouse. Position the mouse cursor at the top left corner of the region you wish to magnify, hold down the left mouse button, move the mouse to the bottom right corner and release the mouse button.

To zoom out again in order to view the whole graph, drag out a region as before, starting from the bottom right to the top left.

This zoom facility can be used in conjunction with the analysis graph scroll bar, to aid in visualization of the chart.

The **Auto Range** function can be toggled on and off by a mouse click. When on, the check box is labeled with a tick and the Analysis plot is automatically scaled for greatest clarity.

The plot to be displayed is selected from the Dropdown listbox:

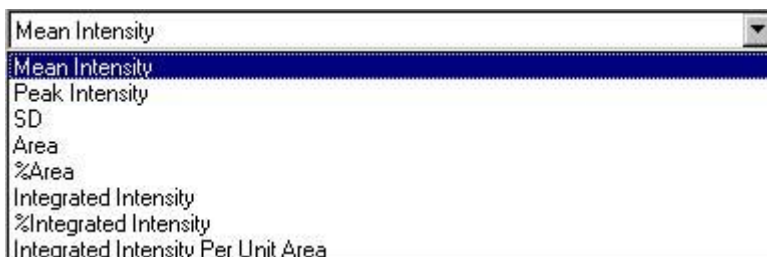

The available plots for display will depend upon the statistics selected on the Options page for calculation at the start of the Analysis.

If the **Show Event Labels** checkbox is enabled, Event Markers and associated labels will be displayed on the Graph page.

If the **Show Legend** checkbox is enabled, the Legend will be displayed on the Graph page.

If a suitable printer is installed, a hard copy of the charted data can be produced by clicking on the **Print** button.



The **Colour Box** button allows the colors of the Graph (Background, Labels and Grid Lines) to be changed.

5.3.2 The Data Page

Class	Area (mu*mu)	Frame	Time (ms)	Mean Intensity
1(2)	246.3214	1	3029	44.5064
1(2)	246.3214	2	6504	42.9716
1(2)	246.3214	3	9408	43.6839
1(2)	246.3214	4	12395	44.4762
1(2)	246.3214	5	15416	43.4715
1(2)	246.3214	6	18419	43.7907
1(2)	246.3214	7	22162	44.843
1(2)	246.3214	8	25372	43.9566
1(2)	246.3214	9	28337	45.7334
1(2)	246.3214	10	31341	45.2483
1(2)	246.3214	11	34362	46.6086
1(2)	246.3214	12	37348	45.0518
1(2)	246.3214	13	40360	46.7348

The statistics calculated depend upon the statistics selected for calculation on the Options page at the start of the Analysis.

Mean Intensity the Mean intensity value of the selected region and time frame.

Peak Intensity the Peak intensity value of the selected region and time frame.

SD the Standard Deviation of the selected region and time frame.

Area the number of pixels within the region within the threshold limits specified in the Settings dialogue (**Section 5.4.1**).

%Area the percentage of the area within the threshold limits specified in the Settings dialogue (**Section 5.4.1**).

Integrated Intensity the integrated intensity within the threshold limits specified in the Settings dialogue (**Section 5.4.1**).

%Integrated Intensity the percentage of the integration within the threshold limits specified in the Settings dialogue (**Section 5.4.1**).

Integrated Intensity Per Unit Area the integrated intensity divided by the number of pixels (i.e. the area) within the region.

Note: That in the above diagram, the displayed data is for Region 1, which is classified as Blue on the image (to select a different color, select the Pointer tool from the Image Toolbar, right click on the region and select Classify).

If **Group Analysis** is selected on the Options page; the data is displayed for every Group (color) rather than every Region. The Group column in the data table will list a second number in brackets e.g. 1(4) which signifies that there are four regions in that class.

5.3.3 The Options Page

Please refer to **Section 5.5** for further information regarding Analysis Options. We arrange the information in this sequence because Analysis and RGB Analysis share Data Options and so the information has been merged into a single section.

5.4 RGB Analysis and Co-Localization

The RGB Analysis Tab opens the RGB Analysis Window, which is used to calculate statistics for color RGB images, or for user-defined regions on the image.

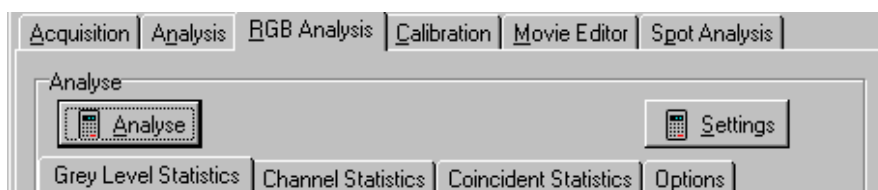

5.4.1 Grey Level Statistics

Statistics are calculated for grey-scale images:

Notes	Image	Mean Grey	Min Thresh Grey	Max Thresh Grey	Rgn X to
1	C:\DEMO1	194.72	10.00	:255.00	265
2	C:\DEMO2	115.02	10.00	:255.00	156

Pressing **Analyse** will perform the analysis on all regions defined on the image using the ROI tools (if no regions have been defined, the analysis will be performed on the entire image). The results calculated depend upon the statistics selected on the **Options** page (**Section 5.5.1**) and the threshold values applied in the **Settings** dialogue panel.

The data calculated from the analysis is displayed in the table. Each row contains the statistical data for one user defined region of interest. The following data is calculated:

Mean - the mean intensity of the grey pixels

Peak - the peak intensity of the grey pixels

SD - the standard deviation of the grey pixel intensity

Area - the number of grey pixels within the region within the threshold limits specified in the Settings Dialogue.

%Area - the percentage of the area within the threshold limits specified in the Settings Dialogue.

Integrated Intensity - the integrated intensity within the threshold limits specified in the Settings dialogue.

% Integrated - the percentage of the integration within the threshold limits specified in the Settings dialogue.

Minimum Threshold - the lower pixel intensity threshold limit, as specified in the Settings dialogue. Pixels with an intensity outside the minimum and maximum threshold values are ignored.

Maximum Threshold - the highest pixel intensity threshold limit, as specified in the Settings dialogue. Pixels with intensities outside the minimum and maximum threshold values are ignored.

Region-defining coordinates - the X and Y coordinates of the top, left, bottom and right points of the region.

5.4.2 Channel Statistics

The Channel Statistics Tab opens the Channel Statistics page. Statistics can be calculated here on the user-defined regions, for each of the filtered planes specified in the Multi-Wavelength dialogue on the Grab page, e.g. for each of the red, green and blue planes of a RGB image.

Notes	Image	Mean R
1	C:\DEMOIMAGES\KOMET++ IMAGES\KOMET++ 03.TIF	55.66
2	C:\DEMOIMAGES\KOMET++ IMAGES\KOMET++ 03.TIF	71.87
3	C:\DEMOIMAGES\KOMET++ IMAGES\KOMET++ 03.TIF	49.46
4	C:\DEMOIMAGES\KOMET++ IMAGES\KOMET++ 03.TIF	71.59
5	C:\DEMOIMAGES\KOMET++ IMAGES\KOMET++ 03.TIF	9.00
6	C:\DEMOIMAGES\KOMET++ IMAGES\KOMET++ 03.TIF	60.16
7	C:\DEMOIMAGES\KOMET++ IMAGES\KOMET++ 03.TIF	85.87
8	C:\DEMOIMAGES\KOMET++ IMAGES\KOMET++ 03.TIF	65.34
9	C:\DEMOIMAGES\KOMET++ IMAGES\KOMET++ 03.TIF	67.63
10	C:\DEMOIMAGES\KOMET++ IMAGES\KOMET++ 03.TIF	65.95
11	C:\DEMOIMAGES\KOMET++ IMAGES\KOMET++ 03.TIF	61.53

If regions have been defined on the current image, using the Rectangle, Ellipse, Polygon and / or Freehand Polygon buttons in the Image Toolbar, statistics can be calculated on each region for each time frame. (If no regions have been defined, statistics are calculated for the entire image). The calculated statistics are displayed in the chart.

The **Settings** button opens a dialogue in which you can specify what region of color space to consider.

Note: In order to access the Settings button, the **Threshold** option must be ticked in the Options tab. For each of the filtered planes specified during the Experimental setup, e.g. for the red, green and blue planes of a RGB image, use the scrollbars to specify the minimum and maximum pixel intensity values that will be considered. All pixels with intensities within the specified range will be labeled as containing that color component. The specified limits are displayed in the

graphs, and the image in the Image Window is updated as described overleaf, thus enabling interactive optimization.

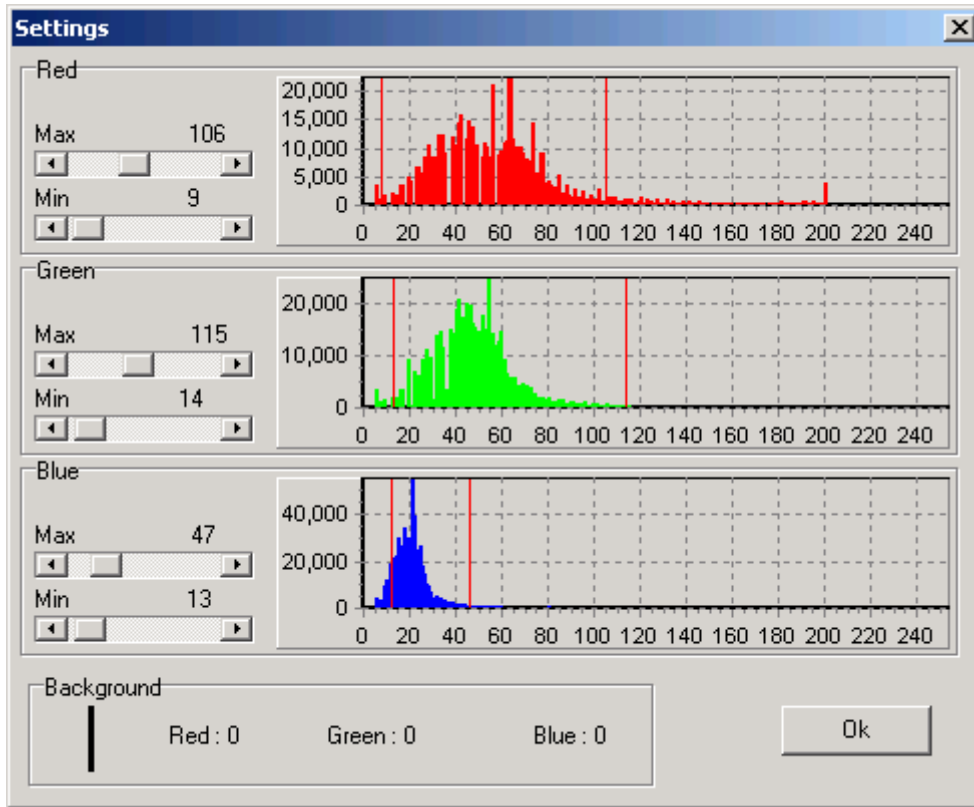

Using the scrollbars, select the minimum and maximum pixel intensity values to be considered for each plane.

Pixels are labeled depending upon whether their intensity lies within the specified range and therefore contains the appropriate component. As you adjust the maximum and minimum pixel intensity values for the red, green and blue planes, the graph to the right of the scrollbars is updated and every pixel in the image displayed in the Image Window will be colored as described facing:

Red	Green	Blue	Assigned Colour
Yes	No	No	Red
No	Yes	No	Green
No	No	Yes	Blue
Yes	Yes	No	Yellow
Yes	No	Yes	Magenta
No	Yes	Yes	Cyan
Yes	Yes	Yes	White
No	No	No	Transparent (the original image is displayed)

For example, all pixels with intensities that lie within the specified range for red and blue but NOT green will be colored magenta on the image.

When the parameters in the Settings dialogue have been optimized, press **OK** to close the dialogue, accepting the specified values.

Pressing **Analyse** will perform the analysis on all regions defined on the image using the ROI tools (if no regions have been defined, the analysis will be performed on the entire image). The results calculated depend upon the statistics selected on the **Options** page (**Section 5.5.1**).

The data calculated from the analysis is displayed in the table.

Each row contains the statistical data for one user defined region of interest.

The following data is calculated for each of the filtered planes specified in the Multi-Wavelength dialogue on the Grab page, e.g. for each of the red, green and blue planes of a RGB image. This data is displayed on the Channel page.

Mean- the mean intensity of the pixels for the red, green and blue channels

Peak - the peak intensity of the pixels for the red, green and blue channels

SD - the standard deviation of the pixel intensity, for the red, green and blue channels

Area - the number of pixels within the region within the threshold limits specified in the Settings dialogue, for the red, green and blue channels

%Area - the percentage of the area within the threshold limits specified in the Settings dialogue, for the red, green and blue channels.

Integrated Intensity - the integrated intensity within the threshold limits specified in the Settings dialogue, for each of the red, green and blue channels.

Chromaticity - color fraction analysis

$$r = R / (R + G + B)$$

i.e. the red chromaticity value equals the mean intensity of the red pixels divided by the mean intensity of the red pixels plus the mean intensity of the blue pixels plus the mean intensity of the green pixels

$$g = G / (R + G + B)$$

$$b = B / (R + G + B)$$

Minimum Threshold - the lower pixel intensity threshold limit, as specified in the Settings dialogue, for each of the red, green and blue channels. Pixels with an intensity outside the minimum and maximum threshold values are ignored.

Maximum Threshold - the highest pixel intensity threshold limit, as specified in the Settings dialogue, for each of the red, green and blue channels. Pixels with an intensity outside the minimum and maximum threshold values are ignored.

Region-defining coordinates - the X and Y coordinates of the top, left, bottom and right points of the minimum enclosing rectangle of the region.

15	15	27.95	27.02	15.67	9.00	14.00	13.00
16	16	35.16	34.15	14.58	9.00	14.00	13.00
17	17	59.87	55.44	20.46	9.00	14.00	13.00
18	18	105.27	52.89	40.03	9.00	14.00	13.00
19	19	64.46	57.76	21.49	9.00	14.00	13.00
20	20	68.32	37.04	23.04	9.00	14.00	13.00

The **Delete** button deletes the entries from the previous analysis from the Analysis Results table.

Once an analysis has been performed, clicking on the **Save** button will open a save dialogue window, allowing the user to specify a directory and file name to which to save the data. The data is saved in tab-delimited format, and can therefore be opened in Spreadsheet packages such as Microsoft Excel.

5.4.3 Coincident Statistics

The Coincident Statistics Tab opens the Coincident Statistics page. Statistics can be calculated here on the user-defined regions, for all pixels labeled with more than one color (i.e. RedGreen, GreenBlue, RedBlue, RedGreenBlue).

Notes	Min Thresh R	Min Thresh G	Min Thresh B	Max Thresh R	Max Th
1	9.00	14.00	13.00	106.00	115.00
2	9.00	14.00	13.00	106.00	115.00
3	9.00	14.00	13.00	106.00	115.00
4	9.00	14.00	13.00	106.00	115.00
5	9.00	14.00	13.00	106.00	115.00
6	9.00	14.00	13.00	106.00	115.00
7	9.00	14.00	13.00	106.00	115.00
8	9.00	14.00	13.00	106.00	115.00
9	9.00	14.00	13.00	106.00	115.00
10	9.00	14.00	13.00	106.00	115.00
11	9.00	14.00	13.00	106.00	115.00

If regions have been defined on the current image, using the Rectangle, Ellipse, Polygon and / or Freehand Polygon buttons in the Image Toolbar, statistics can be calculated on each region for each time frame. (If no regions have been defined, statistics are calculated for the entire image). The calculated statistics are displayed in the chart.

The **Settings** button opens a dialogue in which you can specify what region of color space to consider. This is described in **Section 5.3.1**.

Note: In order to access the Settings button, the **Threshold** option must be ticked in the Options tab.

Pressing **Analyse** will perform the analysis on all regions defined on the image using the ROI tools (if no regions have been defined, the analysis will be performed on the entire image). The results calculated depend upon the statistics selected on the **Options** page (**Section 5.3.4**).

The data calculated from the analysis is displayed in the table.

Each row contains the statistical data for one user defined region of interest.

The following statistics are calculated:

Area - the number of pixels within the region within the threshold limits specified in the Settings dialogue.

%Area - the percentage of the area within the threshold limits specified in the Settings dialogue.

Integrated Intensity - the integrated intensity within the threshold limits specified in the Settings dialogue

Integrated Ratio - the ratio of the intensity of one color component compared to the intensity of another component

e.g. the RedGreen Integrated Ratio = $\Sigma I (\text{Red}) / \Sigma I (\text{Green})$

Minimum Threshold - the lower pixel intensity threshold limit specified in the Settings dialogue. Pixels with an intensity outside the limits are ignored.

Maximum Threshold - the highest pixel intensity threshold limit specified in the Settings dialogue. Pixels with an intensity outside the limits are ignored.

Region-defining coordinates - the X and Y coordinates of the top, left, bottom and right points of the region.

5.5 Analysis Options

5.5.1 The Options Page (Analysis Tab)

The **Options** page is where the Analysis options are specified, and the statistical values to be calculated are selected. All options are selected and deselected by a mouse click. Selected options have their checkboxes labeled with a tick.

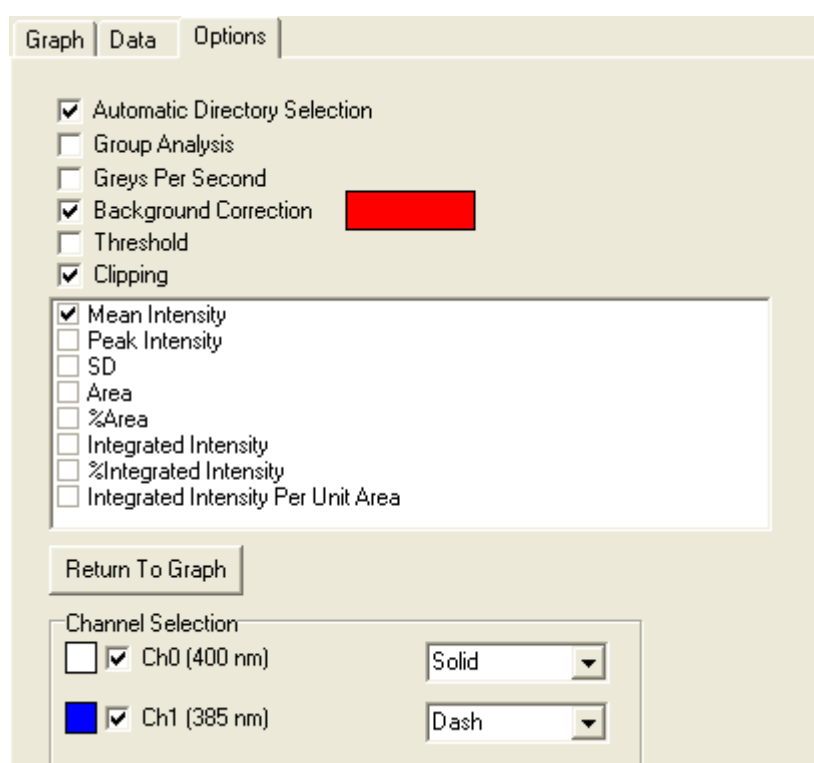

Automatic Directory Selection Once an analysis has been performed, pressing **Save** opens a save dialogue window, allowing the user to specify a directory and file name in which to save the data. If **Automatic Directory Selection** is selected, the default path to which the data will be saved is **C:\AndorBio-imaging\iQData**.

Please note, any path can be defined by a user with administrative rights and it is possible to save data to a different path, using the Set Save Path option in the iQ File menu or specifying a different file path at start up.

Group Analysis Results are calculated for all regions on the image that are in the same group (i.e. all regions of the same color), as opposed to being calculated for each individual region. A region can be assigned to a group by selecting the Pointer tool in the Image Toolbar, right clicking on the region, selecting Classify and assigning a color.

Greys Per Second This option can be used to extend the dynamic range to obtain quantitative information and to directly compare data.

The intensity information is calculated from the grey scale content and the result is normalized (divided) by the exposure time at which the image was acquired. Hence the resultant values are expressed as greys per second and will reflect relative intensities over a greatly enhanced range. This function should be used with background correction for best results.

Background Correction The background value is computed from the Group of Red regions defined on the image using the ROI Tools on the Image Toolbar. If you select the **Background Correction** option then the **Red region** mean value will be subtracted from each pixel during analysis.

Threshold This option must be ticked in order to access the Settings button.

Statistics available for selection are:

Mean Intensity the Mean intensity value of the selected region and time frame.

Peak Intensity the Peak intensity value of the selected region and time frame.

SD the Standard Deviation of the selected region and time frame.

Area the number of pixels within the region within the threshold limits specified in the Settings dialogue (**Section 5.4.1**).

%Area the percentage of the area within the threshold limits specified in the Settings dialogue (**Section 5.4.1**).

Integrated Intensity the integrated intensity within the threshold limits specified in the Settings dialogue (**Section 5.4.1**).

%Integrated Intensity the percentage of the integration within the threshold limits specified in the Settings dialogue (**Section 5.4.1**).

Integrated Intensity Per Unit Area the integrated intensity divided by the number of pixels (i.e. the area) within the region.

At the bottom of the Options Tab under Channel Selection are check boxes to select which channels will be graphed. Use the drop down lists to specify the appearance of each channel on the Graph.

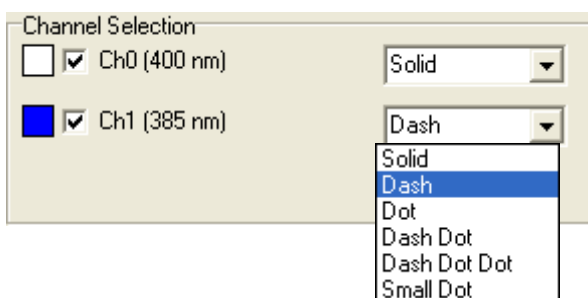

5.5.2 The Options Page (RGB Analysis Tab)

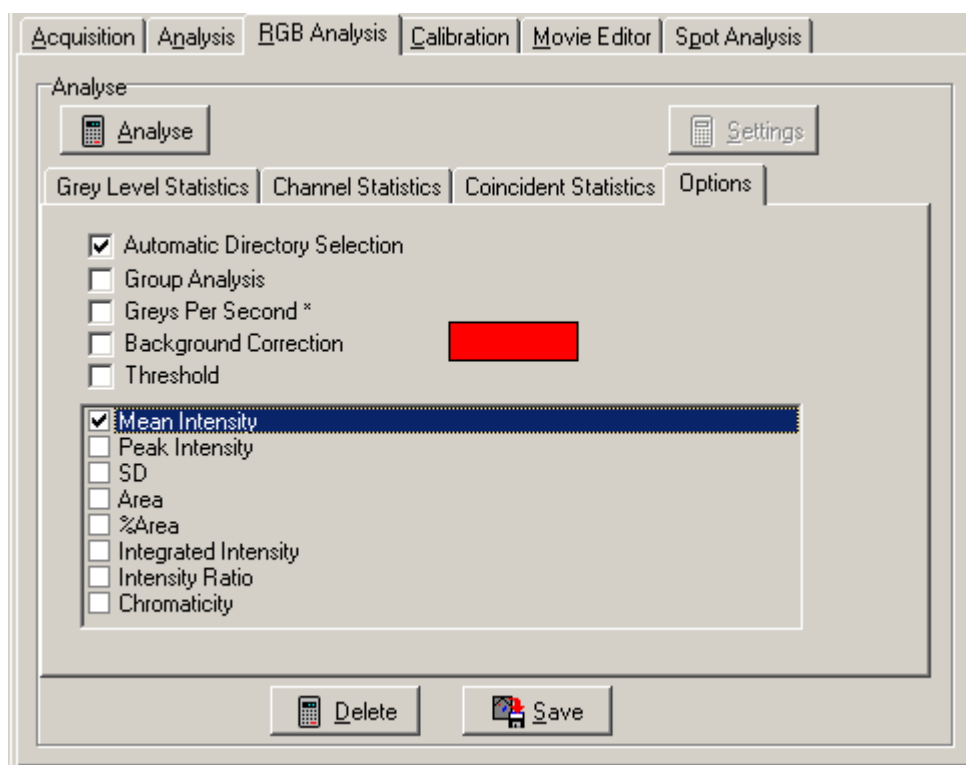

The functionality relating to the checkboxes for **Automatic Directory Selection**, **Group Analysis**, **Greys Per Second** and **Background Correction** have been discussed previously in **Section 5.5.1**.

Statistics available for selection in RGB Analysis are as follows:

Mean- the mean intensity of the pixels

Peak - the peak intensity of the pixels

SD - the standard deviation of the pixel intensity

Area - the number of pixels within the region within the threshold limits specified in the Settings dialogue

%Area - the percentage of the area within the threshold limits specified in the Settings dialogue

Integrated Intensity - the integrated intensity within the threshold limits specified in the Settings dialogue

Integrated Ratio - the ratio of the intensity of one color component compared to the intensity of another component

e.g. the RedGreen Integrated Ratio = $\Sigma I (\text{Red}) / \Sigma I (\text{Green})$

(This statistic is only displayed on the Coincident Statistics page).

Chromaticity - color fraction analysis

$$r = R / (R + G + B)$$

i.e. the red chromaticity value equals the number of red pixels divided by the total number of all color pixels (red + green + blue)

$$g = G / (R + G + B)$$

$$b = B / (R + G + B)$$

5.5.3 Group Analysis

The analysis of regions of interest is a common action in image analysis. In iQ, regions can be defined in any combination of rectangle, ellipse, polygon or freehand polygon. These types are selected from the Image Toolbar as described in **Section 2.11**. As regions are drawn they will be given colors according to the specified class of region (**Section 2.3.9**). When analysis is performed regions of the same color will be placed together in the data table, but each region will have its own separate statistics in the table.

However, when you have several regions of the same color, representing discrete parts of a sample feature or phase you may wish to view the analysis results from the regions as cumulative statistics or as a **Group**. To achieve this, you select the Group Analysis option check box on the Options dialogue and then all regions of the same color will be treated as one combined region. The data analyzed for all these regions will be grouped and reported as one data row.

One further important consequence of the **Group** option, when selected, is that regions of the same feature (color) that overlap will **exclude** the overlapping area from analysis. In this way regions within regions can be used to create **holes** and regions within holes can be used to create **islands** and so forth (**Figure** , where all regions have been classified as blue and therefore the enclosures create holes and islands). This provides a powerful tool for analysis of many irregular naturally occurring features and structures.

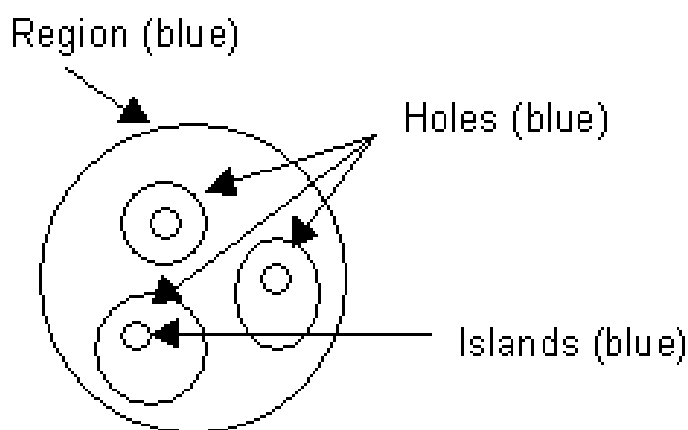
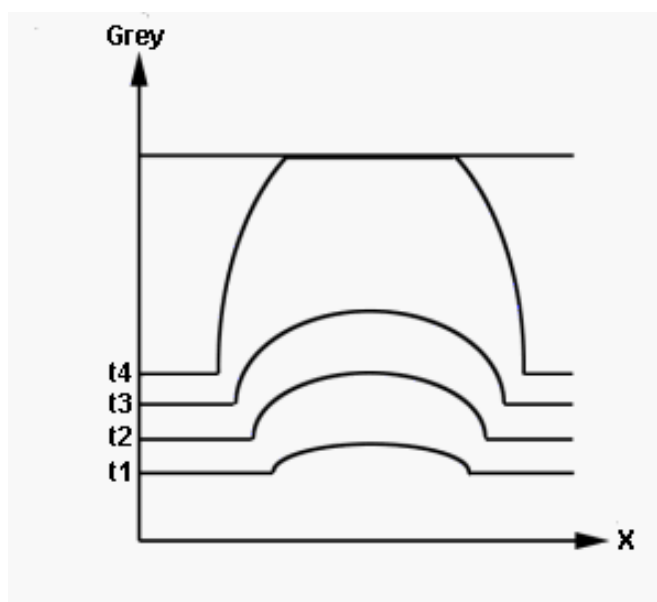

Figure - ROI's and Group Analysis

5.5.4 Background Correction

When analyzing fluorescent images, the image can be considered composed of bright objects on a dark background. In most circumstances the background value can be considered as the "black level" or an image offset. To obtain precise intensity data from the bright objects of interest it is common to correct for this background value by subtracting it from each pixel during analysis. The background value is computed from a region within the image and the mean value from the region is used. In iQ the background value is computed from the Group of Red regions in the image. If you select the **Background Correction** option then the **Red region** mean value will be subtracted from each pixel at analysis time.



At increasing exposure times the background increases slightly, while the peak intensity increases more dramatically. At longer exposure times saturation occurs and the profile is 'flattened' as displayed above, resulting in lower intensity values than expected.

5.5.5 Greys per Second

When an integrating CCD camera is used to capture data from samples with variations in intensity, it is possible to use region analysis to obtain an indication of the amount of fluorochrome present. However, most systems simply report grey level values without reference to the camera exposure time. This is adequate for comparison of samples that can be imaged at the same exposure time, but clearly does not take advantage of the dynamic range available when exposure time is varied. For example an 8 bit camera has a range of maybe 100 when background level and noise is taken into account, but if the exposure time can be varied from 40 ms to 1 second then the range is 100×25 i.e. 2500. In 12-bit cooled CCDs this is even more pronounced. Thus if the exposure time is used in the calculation a huge increase in analysis range can be achieved, which is a major benefit for scientific applications in areas such as GFP quantification in gene expression.

For this reason, iQ has been given the option of ***Greys per second***. If this option is selected then the intensity information is calculated from the grey scale content and the result is normalized (divided) by the exposure time at which the image was acquired. Hence the resultant values are expressed as greys per second and will reflect relative intensities over a greatly enhanced range, which depends on the exposure time range and bits per pixel of the camera. Optimum results will generally be obtained by using Background correction with Greys per second.

5.6 The Movie Editor

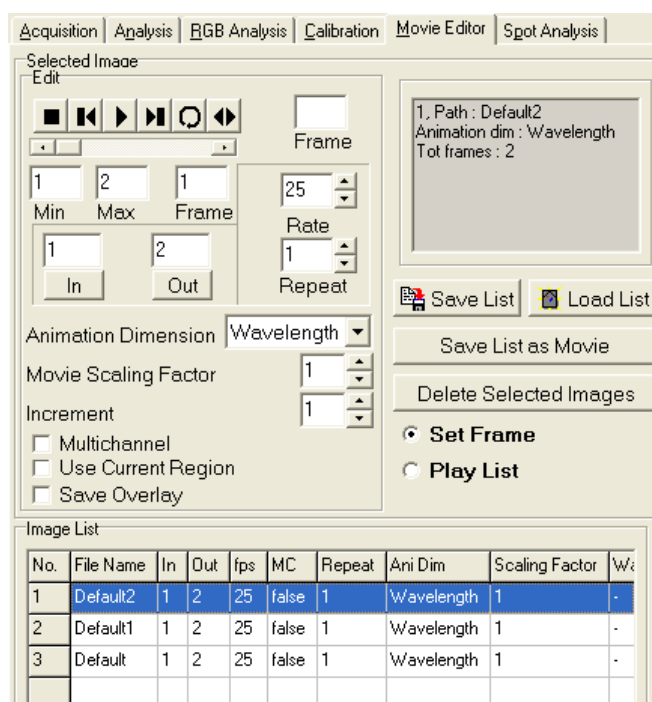

The Movie Editor is used to create animation sequences from frames of interest in your images, which can be saved as AVI Movies.

Images included in the animation are displayed in the list at the bottom of the dialogue.

To add an image to the list, either open it from the **File Menu** or **Show** it from the **Image List**.

To remove images from the list, select them with the mouse and press **Delete Selected Image**.

(Information on the selected image is displayed in the top right of the dialogue, including the path, image name, animation dimension and number of frames).

There are two modes of operation:

Set Frame - specify the parameters for each of the images in the List, as described below.

Play List - after setting up the parameters, play the animation before saving as an AVI Movie.

In **Set Frame mode** you can specify the following parameters for the selected image:

Starting and Final Frame

Using the animation buttons or scrollbar, animate to the first frame to include and press **In**, then to the final frame and press **Out**. The frame numbers will be updated in the **In** and **Out** columns in the table.

Note: The numbers of the first and final frames of the image are displayed in the **Min** and **Max** text boxes. The current frame is displayed in the **Frame** text box).

Speed of Animation

Rate specifies the number of frames to display every second. Type a value into the text box or using the scrolling arrows, the value will be updated in the **fps** column.

Number of Repeats

Enter the number of times you want the image to play during the animation (type a value or use the scrolling arrows).

Animation Dimension

For multidimensional images that contain more than 3 dimensions, select the dimension along which you want to animate.

Movie Scaling Factor

The sampling factor for the image when saved as an AVI Movie. A sampling factor of 0.5 will result in a half sized image, 0.33 a third sized image etc. **Note that you should NOT Zoom the rendered image with the Image Window Zoom tool.** Use this setting for correct Zoom in the AVI output.

Note: This is only displayed in the Saved Movie, not while animating in Play List mode.

Increment

This specifies which frames to include in the animation. An increment of one will animate through all frames, a value of 2 will display every second frame etc.

Multi-channel

For multi-channel images, the resultant AVI movie file is saved as 24-Bit image data. If the check box remains unchecked only the first plane in the multi-channel data set is saved to disk.

Use Current Region

This option enables only image data lying within a user defined rectangular ROI to be saved as an AVI movie file.

Save Overlay

This option enables Text and Time stamp over lays to be exported with AVI's. After specifying the images to include and their parameters, **Play List** mode lets you play the movie, using the animation buttons.



The buttons from left to right are:

Stop - stops the animation

Jog Back - rewinds the animation 1 frame

Play - animates through the Play List

Jog Forward - advances to the next frame

Loop - animates through the Play List as does the Play button, but on reaching the end of the animation it repeats, starting from the first frame

Bounce - continually plays the animation, forwards then backwards and so forth

You can also animate through the Play List by dragging the scrollbar.

The current frame number is displayed in the **Frame** box.

The Play List can be saved to disk by pressing the **Save List** button, from where it can later be reloaded by pressing **Load List**.

To save the animation as an AVI Movie press **Save List as Movie**. You will be prompted to select a filename and path for the Movie. You will also be asked to save the Playback Frame Rate for the movie (i.e. the speed of the movie, in Frames per Second). Finally you can specify the movie compression.

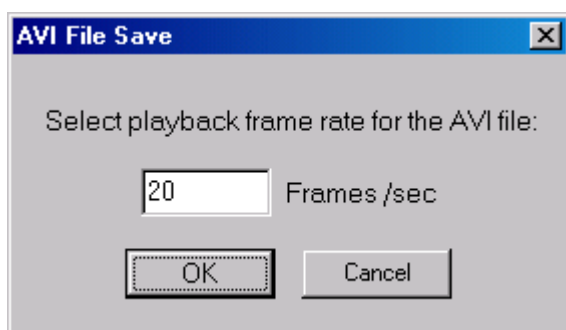

The saving of AVI Movie files is illustrated in the series of screenshots shown below.

Specification of playback frame rate following selection of filename and path.

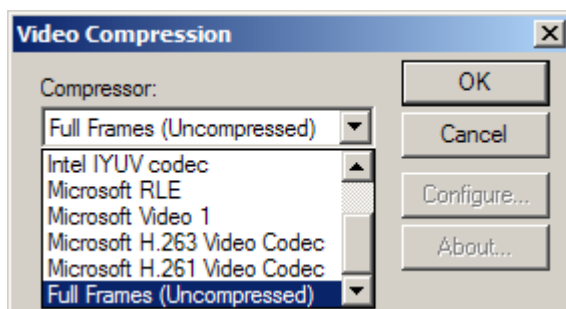

Specification of compression + decompression algorithm (aka codec) to use for movie compression.

The choice of compressor is dependent upon which codecs are installed on the system. For example, on a default Windows 2000 installation, the Cinepak, Intel

Indeo (R3.2) and Microsoft Video 1 codecs are available. Alternatively, Full Frames can be selected, which will not compress the frames. Be aware, however, that files exported in this way could be very large and compression may offer a better size / quality payoff for portability.

The table below summarizes the main differences between these codecs.

Codec	Speed	Size (relative to uncompressed file)	Quality
Cinepak	Slow	Approx. 1/10	Good
Intel Indeo	Fast	Approx. 1/14	Medium
Video 1	Fast	Approx. 1/3	Good

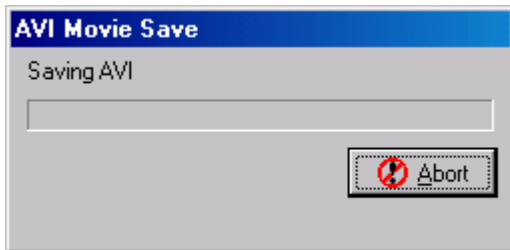

The results will vary depending on the sequence you wish to export. Extremely detailed images with larger uniform areas will compress better than highly detailed images with small, well-defined areas. It would be beneficial to

experiment with a short frame sequence using different codecs and different quality settings in order to achieve the best size / quality ratio. A suggested starting point would be the Cinepak codec with a quality of 75.

Following the specification of a frame rate and compression format, a progress bar monitors the AVI Movie Save process.

5.7 The Spot Function

The Andor Technology “Spot” software was originally developed to quantify ploidy (chromosome number) distribution in cell populations, especially tumor cells. The basis of this approach has been proposed in the analytical cytometry literature for some time. By staining the cell nuclear DNA with a fluorescent probe and viewing in a fluorescence microscope, it is possible with image analysis to quantify the fluorescence intensity. This is after all the basis for flow cytometry and fluorescence activated cell sorting (FACS). However, using a microscope image cytometry approach, it appears that analyzing only a few hundred cells could perform a comparable task at lower cost and with less sample material.

Spot has however proven to be of broader application and can be applied to the quantification of the morphology and density or intensity of any population of discrete objects. The image analysis allows intensity discrimination (thresholding), object measurement and filtering (inclusion or rejection) and statistical analysis and presentation of the population data. The results can finally be exported to a spreadsheet for further analysis.

An image-based object review interface shows all selected objects and allows the user to rapidly identify and reject artifacts. In statistical plots (histograms and scatter plots) clusters can be selected or rejected from the analysis.

Spot functions include:

Analysis protocol file management

Interactive threshold selection

Interactive object parameter filtering, based on Area, integrated intensity and shape factor

Batch processing of file lists using user-selected protocols Analysis of time-series images for studying spot dynamics.

Numeric and image-based object review tools

Histogram and scatter plot presentations, with parameter range selection/ rejection

Export of selected data for further analysis in spreadsheets

Spot provides a straightforward user interface, with powerful interactive configuration and automatic processing of image sets. The overall goal being to provide a flexible yet rapid and easy-to-use solution to a class of image analysis problems commonly found in bio and industrial imaging. We hope it proves useful in your studies.

Analysis may be performed on images acquired using iQ or previously captured using third party software and stored on disk.

5.7.1 Analysis of Images Acquired Using iQ

Spot will analyze images captured using iQ in the following ways:

Analysis of a single image captured using the Snap command. Please refer to **Section 3.4.2** of the iQ user guide for further details.

A batch (set or group) of images for cumulative analysis, such as may be obtained from multiple fields from the same sample to ensure suitable sample size or spatial sampling. Please refer to **Section 3.3** of the iQ user guide for a complete description of the multiple field sampling functions.

A time-series of individual image files or a multi-dimensional time-series image for analysis of spot feature dynamics. Please refer to **Section 3.4.4** of the iQ user guide for a description of how to perform a time-lapse experiment.

To obtain accurate analysis data, a valid XY calibration must be used during image capture and further details concerning the calibration of images can be found in **Section 2.7.4** and of the iQ user guide.

5.7.2 Analysis of Images Acquired Using 3rd-Party Software

The following image types can be imported into the iQ for subsequent Spot Analysis:

An individual image file.

Microsoft Windows AVI media files.

A multi-TIFF time sequence.

A time-series captured using third party software.

iQ supports a wide range of file types, which can be loaded into iQ for analysis. Images must be loaded into iQ before Spot Analysis can be performed. Further details concerning supported file types can be found in **Section 2.4**.

Images are loaded using the iQ file menu as discussed previously in **Section 2.6.1** and **Section 2.9.1**.

Alternatively, the Image Window menu can be used. Further details regarding these functions can be found in the iQ user guide in **Sections 2.6.1** and **2.9.1**, respectively.

A typical open file dialogue is shown below which is applicable to an individual image file or a multi-TIFF time sequence.

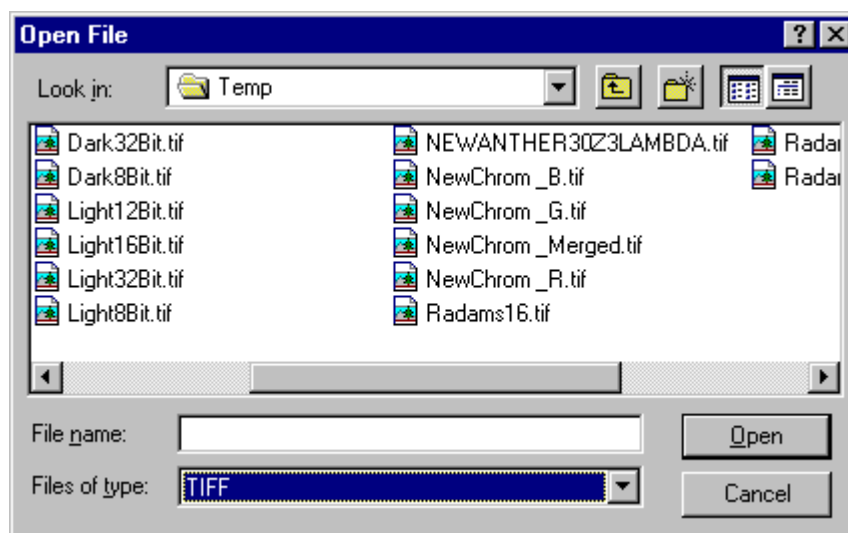

For a time series captured using third party software, the Multi-Load file type should be selected as shown below.

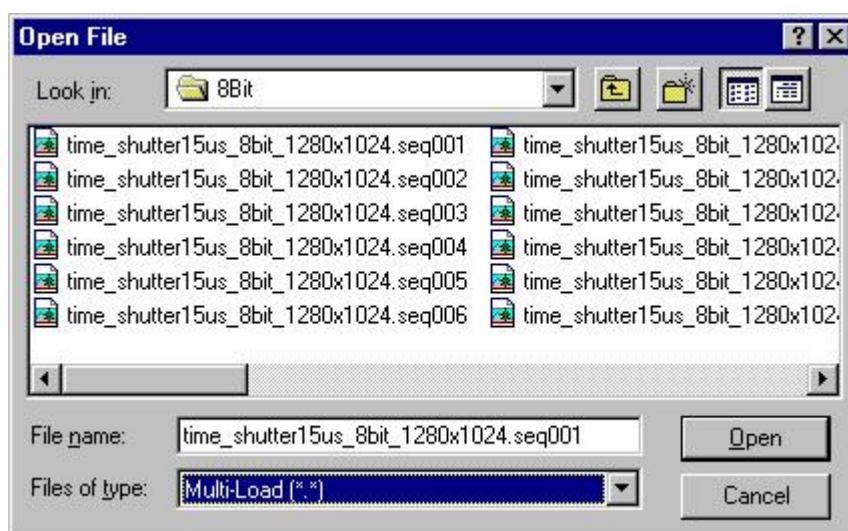

Selecting the first file in the appropriate directory and clicking on the Open button loads a group of individual images constituting a time series.

For further details about opening images please refer to **Sections 2.9.1 and 2.6.1**.

5.7.3 Using Spot Analysis

Clicking on the Spot Analysis tab in the iQ window accesses the Spot Analysis module. A successful analysis can only be performed following the definition of a suitable experimental protocol.

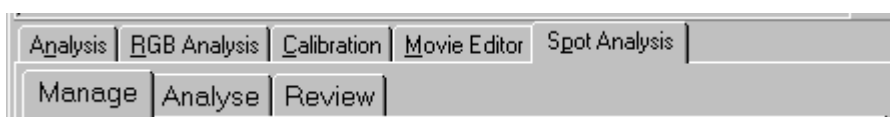

5.7.4 Managing Analysis Settings

 The Manage dialogue is used to set up an analysis protocol and specify the parameters for analysis. The set up procedure is accomplished with the aid of a set up wizard and defines the threshold and filter limits for the analysis. A new analysis protocol file can be created or an existing protocol file edited during the set up procedure using the Analysis Manager wizard.

When the Manage tab is selected the following panel appears.

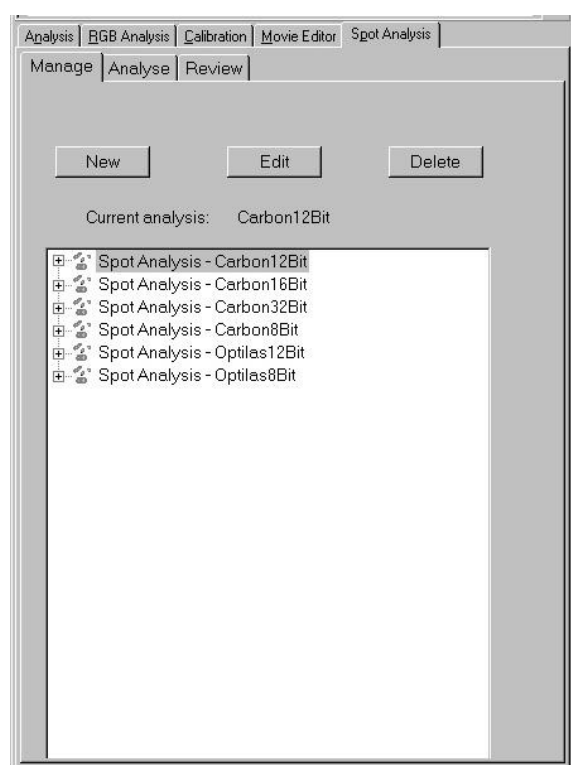

The example panel shows a list of experimental protocol files created during previous Spot Analysis sessions.

Spot protocol files are selected by clicking on the relevant file name. Clicking the + symbol reveals the analysis setup details for a particular protocol. The listing shows the image used to define the protocol, whether bright or dark objects are to be measured, the thresholds used to create a binary image for subsequent measurement and the filter criteria used for data exclusion.

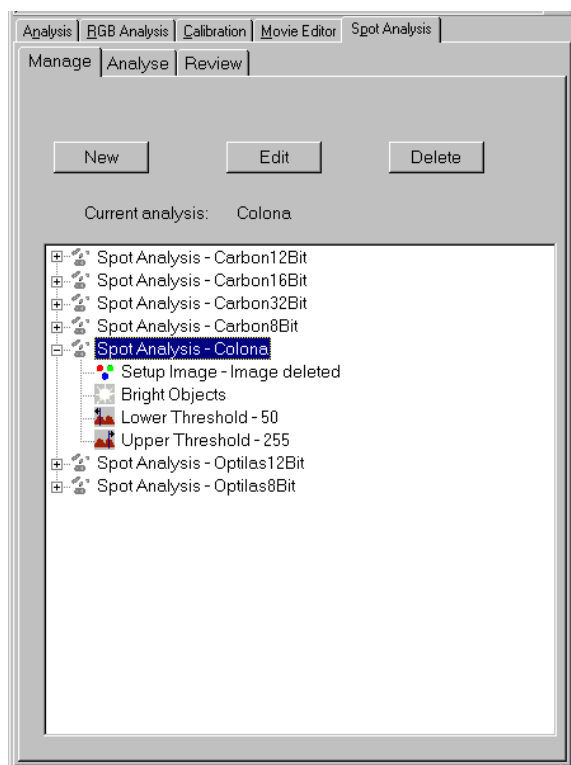

An example panel showing the experimental details for the protocol file Colona is shown left.

5.7.4.1 New Analysis Protocols

A new experimental protocol is created by pressing the **New** button, which reveals the panel shown right.

Before proceeding to the next page of the set up wizard you must enter the name of your file in the Analysis Name text box and select an image to be used for setting up your experimental conditions.

An image can be selected from the Image List or captured from your current sample using the Snap option.

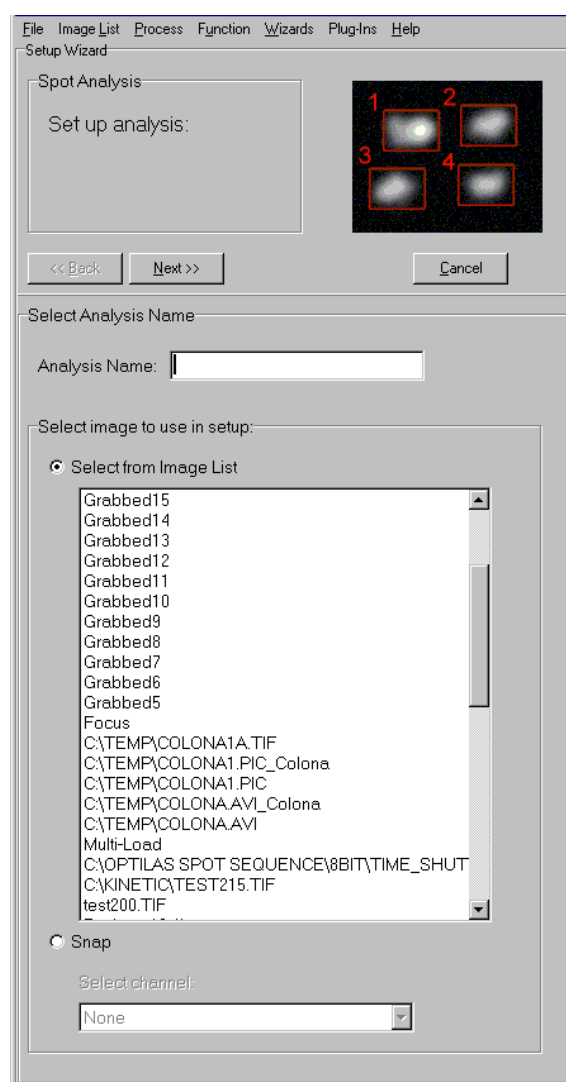

Once a file name has been specified and an image selected click the **Next** button to proceed to the next page of the wizard.

A panel is displayed to enable the specification of threshold limits for the analysis.

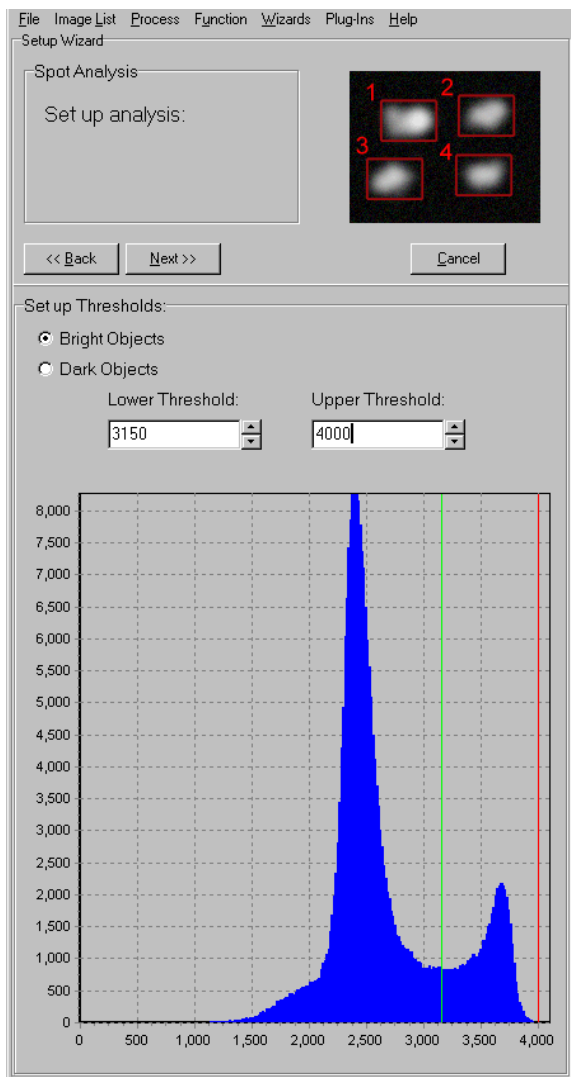

An image histogram is displayed, lower and upper threshold limits represented by two vertical lines. The green and red lines representing the **Lower Threshold** and **Upper Threshold**, respectively.

The threshold limits can be adjusted using the spin buttons or alternatively, typing new values into the respective text boxes.

A binary image created using the specified threshold values is displayed to the right of the image histogram panel.

As the threshold values are adjusted, the image is updated. This can be compared to the original image, and the effects of the various thresholds optimized. A grey level image and a complimentary binary image are shown below.

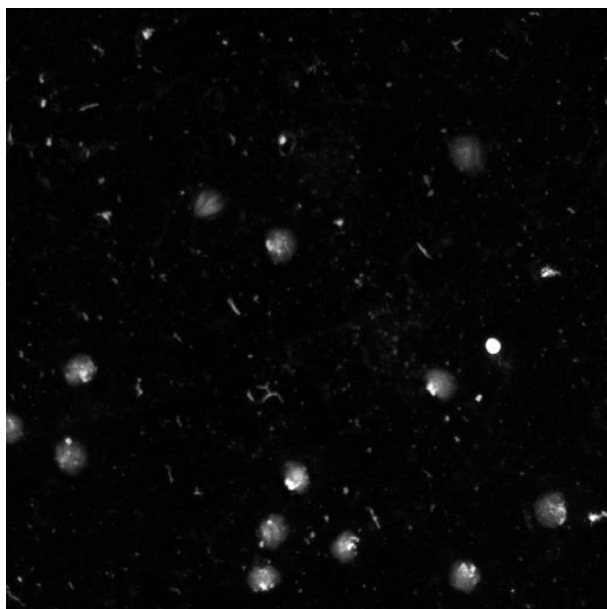

Grey level image

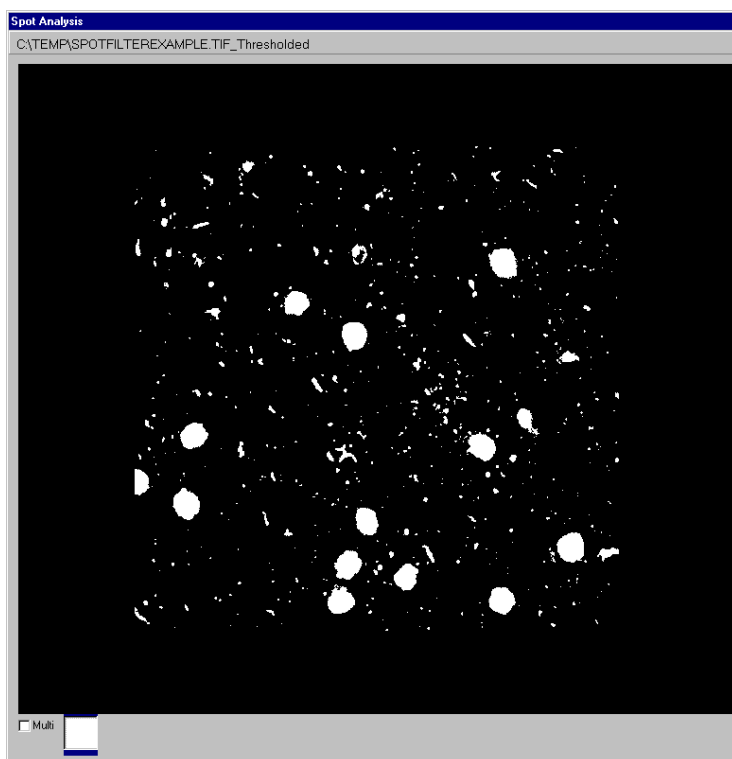

Binary image

Lower Threshold: 20

Upper Threshold: 255

Once you have set the Threshold Limits, click on the **Next** button to continue with the protocol set up.

Pressing the **Cancel** button will close the Manage dialogue, ignoring any changes to the protocol file.

Pressing the **Next** button moves to the filters section of the Wizard where filter limits are specified for the opened image.

The filters panel shown below is used to select which filters are to be applied to an image for subsequent processing and to specify individual filter parameters.

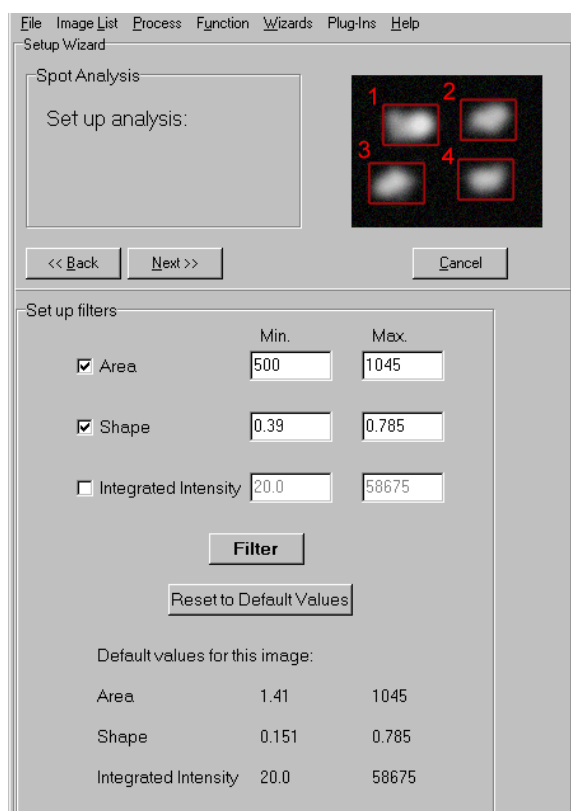

Available filters are **Area**, **Shape Factor** (or circularity - a perfect circle will have the value 1) and **Integrated Intensity**. Their selection can be toggled on and off by a simple mouse click in the selection boxes. Selected filters have their check boxes labeled with a tick. It is not necessary to select any of the filter parameters; if none are selected images will be processed without filtering.

The text boxes to the right of each filter are used to specify a minimum and maximum value for that parameter. Values outside the specified range will be ignored. To alter a value, type the new value into the text box. After adjusting the filter range or selecting/deselecting a filter, clicking on the **Filter** button updates the filtered image window. This image can be compared and the effects of individual filters or combinations of filters optimized.

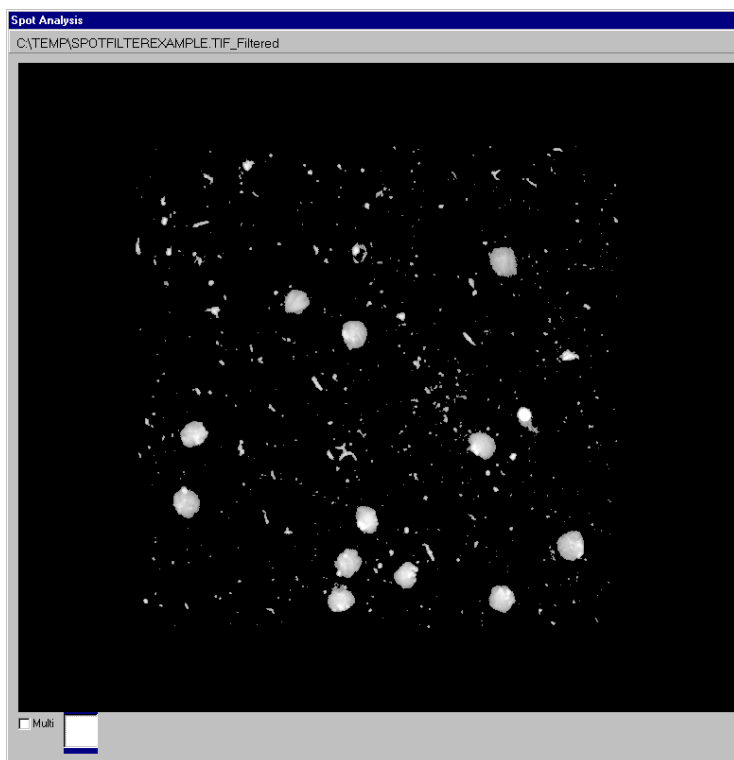

No filter applied

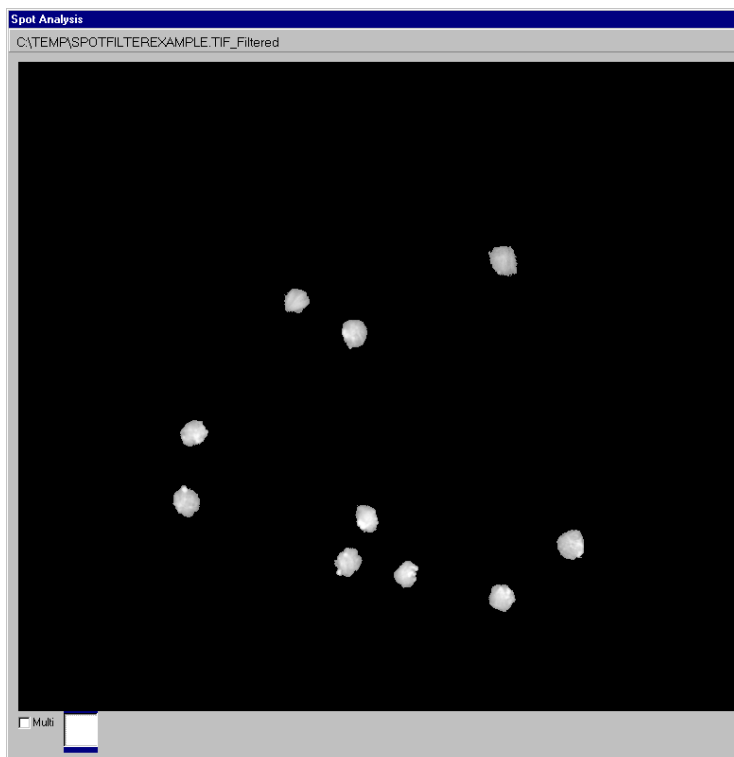

Filter combination applied

Filter (Min/Max)
Area (500/1055)
Shape (0.39/1)

The **Reset Default Values** button restores the **Min** and **Max** parameters to their default values.

HINT - *The **Min** and **Max** range settings provide limits for feature detection. If you are setting up you may wish to change these to include a wider range to ensure the measurement of all objects that are likely to occur, rather than just the range analyzed in the set-up.*

Any changes to the proposed protocol and their subsequent effect on the current image can be evaluated by moving through the set up wizard using the **Back** and **Next** buttons, changing the threshold and filter values where appropriate.

Note: Please note that Spot Analysis discards features lying on the boundaries of the image, as their measurement would lead to an underestimation of true feature dimension.

After selecting which filters to use and specifying their **Min** and **Max** values, click on the **Next** button to continue. The creation of a new experimental protocol file is now complete.

The example shown is for a single image. An identical dialogue is observed for a multi-TIFF time series or a time series generated using third party software.

5.7.4.2 Editing Protocols

An existing protocol can be amended by pressing the **Edit** button, which reveals the panel over.

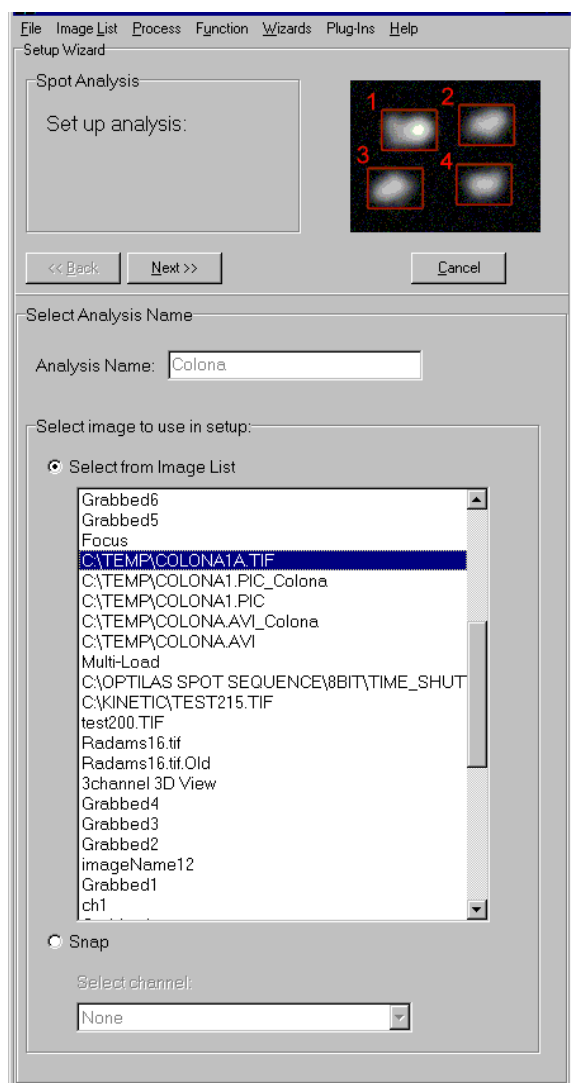

To edit an existing protocol, select the appropriate file name and image.

Press **Next** to continue.

Subsequent threshold and filter dialogues are identical to those described previously.

5.7.5 Analyzing Images

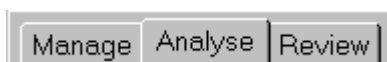

To perform a Spot Analysis using a protocol file selected previously in the Manage dialogue click on the Analyse tab, the panel shown below is displayed.

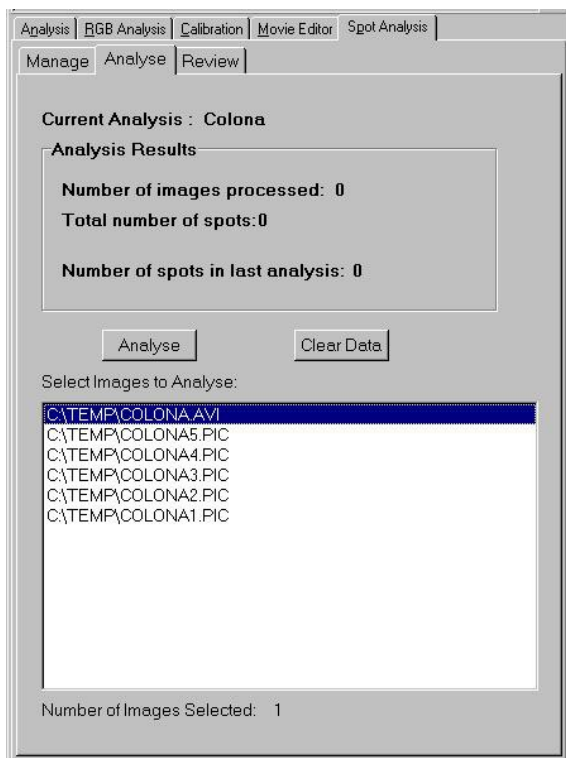

Individual images or a group of images are selected from the Image List as shown.

The images are analyzed using the threshold and feature filter settings defined in the current analysis protocol.

Data resulting from a previous analysis can be deleted from memory prior to performing an analysis by pressing the **Clear Data** button.

Once images have been selected for analysis the Spot Analysis is executed by pressing the **Analyse** button, a progress bar continually monitors the status of the analysis.

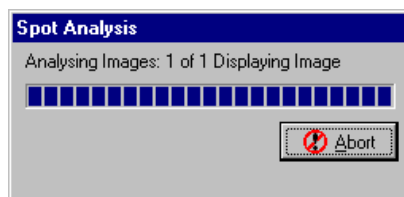

On completion of the analysis, the Analyze panel dialogue is updated to show the number of images processed and the total number of spots detected.

The current image is displayed in the Image Window and an overlay is superimposed showing the identification number for each feature assigned during quantification and its corresponding bounding rectangle.

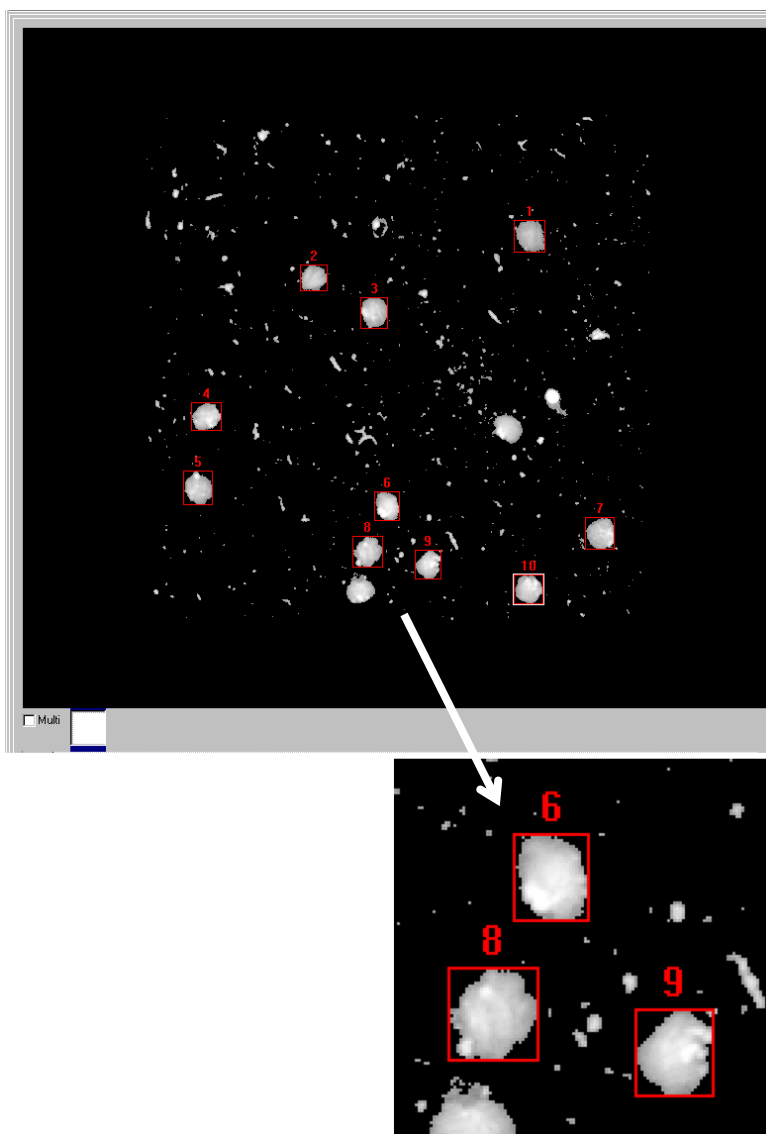

5.7.6 Reviewing and Editing Data

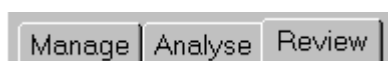

On completion of a Spot Analysis the results can be examined by clicking on the **Review** tab. A panel is displayed as shown below.

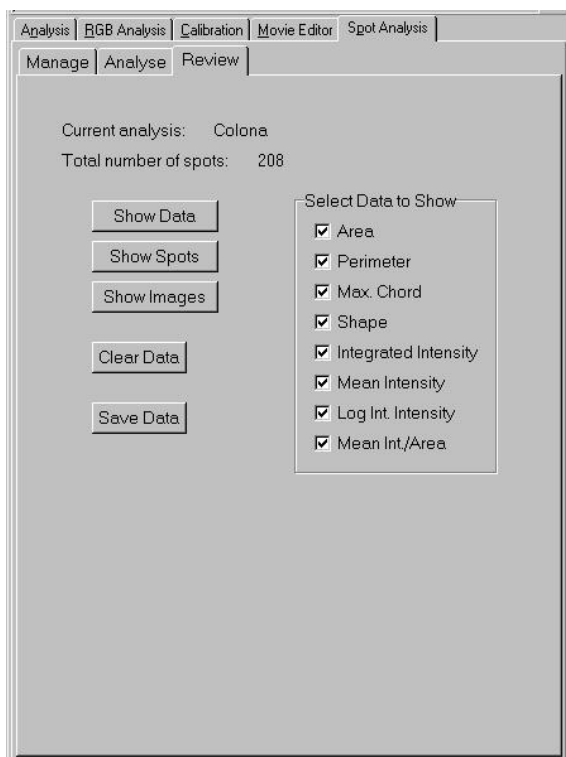

Data for up to eight parameter columns can be displayed for each feature and the required parameter measurements can be selected by ticking the respective check boxes as shown.

5.7.6.1 Show Data Table

Pressing the **Show Data** button displays all the feature data calculated from a previous Spot Analysis in tabular form. The quantified parameter data for each feature is listed as a row in the table, listed in order of ascending number.

The numbers in the column Cell No correspond to those assigned during quantification. A data table from the analysis of an individual image is shown below.

Data Review									
File Plots Data View									
Cell No.	Frame	Area	Perimeter	Max Chord	Shape	Int.Int.	Mean Int.	Log Int.Int.	
<input checked="" type="checkbox"/>	Cell 59	15	894.000	134.000	39.000	0.626	66863.000	74.791	11.110
<input checked="" type="checkbox"/>	Cell 60	15	757.000	130.000	42.000	0.563	63747.000	84.210	11.063
<input checked="" type="checkbox"/>	Cell 61	15	633.000	118.000	34.000	0.571	36182.000	57.160	10.496
<input type="checkbox"/>	Cell 62	15	1261.000	166.000	50.000	0.575	116156.000	92.114	11.663
<input checked="" type="checkbox"/>	Cell 63	15	523.000	110.000	34.000	0.543	36507.000	69.803	10.505
<input checked="" type="checkbox"/>	Cell 64	15	758.000	130.000	39.000	0.564	66491.000	87.719	11.105
<input checked="" type="checkbox"/>	Cell 65	15	749.000	134.000	44.000	0.524	57678.000	77.007	10.963
<input type="checkbox"/>	Cell 66	15	1384.000	198.000	63.000	0.444	133665.000	96.579	11.803
<input checked="" type="checkbox"/>	Cell 67	15	1166.000	158.000	45.000	0.587	119869.000	102.804	11.694
<input checked="" type="checkbox"/>	Cell 68	16	903.000	148.000	43.000	0.518	76315.000	84.513	11.243
<input checked="" type="checkbox"/>	Cell 69	16	698.000	120.000	34.000	0.609	63339.000	90.744	11.056
<input checked="" type="checkbox"/>	Cell 70	16	1052.000	152.000	50.000	0.572	103338.000	98.230	11.546
<input checked="" type="checkbox"/>	Cell 71	16	779.000	130.000	37.000	0.579	36473.000	46.820	10.504
<input checked="" type="checkbox"/>	Cell 72	16	823.000	130.000	36.000	0.612	67205.000	81.659	11.116
<input checked="" type="checkbox"/>	Cell 73	16	760.000	130.000	39.000	0.565	64076.000	84.311	11.068
<input type="checkbox"/>	Cell 74	16	3504.000	300.000	84.000	0.489	519853.000	148.360	13.161
<input checked="" type="checkbox"/>	Cell 75	16	848.000	142.000	44.000	0.528	75970.000	89.587	11.238

Total Spots: 102
 Included Spots: 99

All Data
 Single Frame

The check boxes to the left of each row can be used to mark a feature for rejection. A feature can be rejected from the data analysis by clicking on the appropriate check box using the left mouse button; the check box subsequently appears blank. Data for all the features analyzed is selected automatically by default.

A visual appreciation of the data rejected from the analysis can be gained by using the **Show Data** function in combination with the **Show Spots** option (a discussion of the spot gallery is provided in **Section 5.7**, below).

When the data table and spot gallery are both open, spots removed from the analysis by clicking on the appropriate check box in the data table are identified by red crosses in the spot gallery. Similarly, data can be rejected by clicking on a spot in the gallery, the data table being updated accordingly.

Note: Please note that for data containing a large number of spots, the construction of the data table and spot gallery may take some time. A progress bar will show activity in this case.

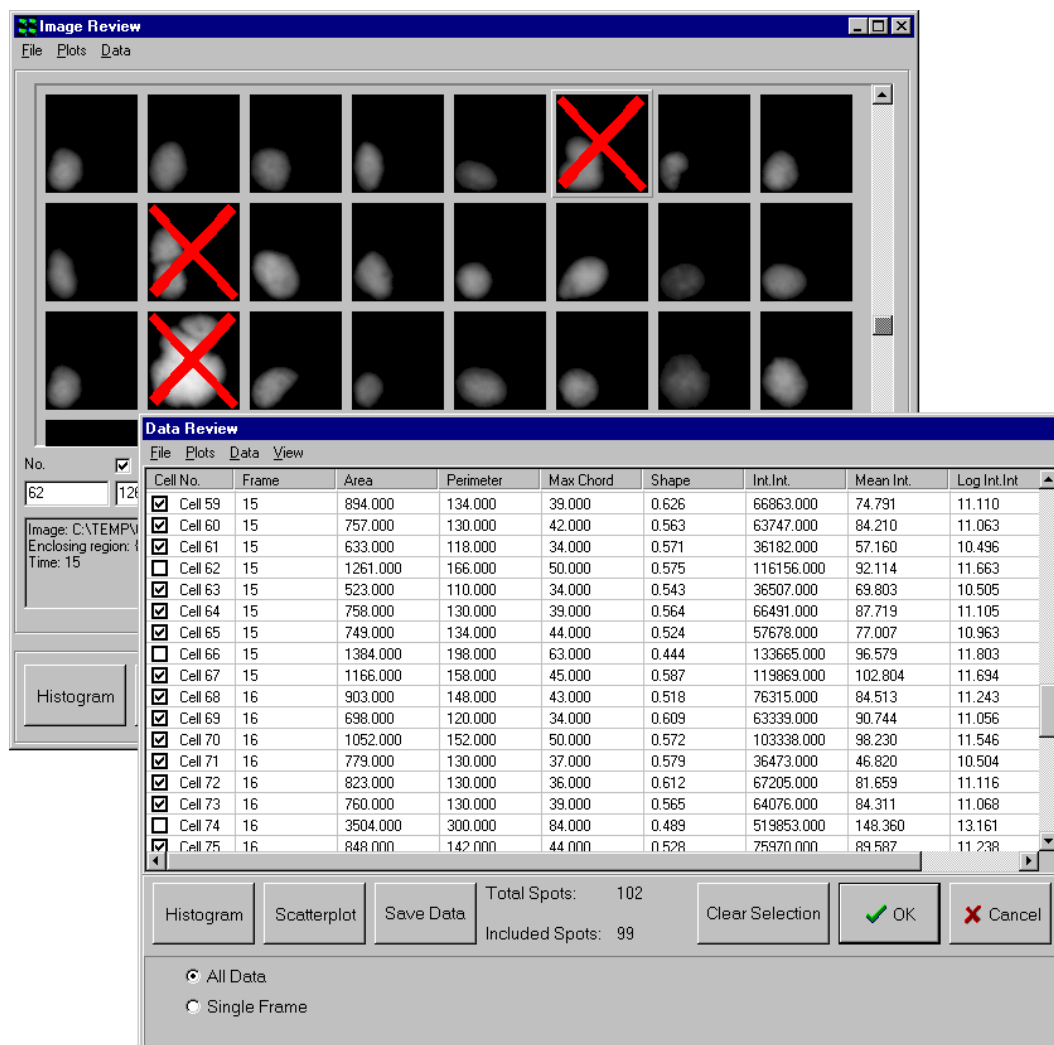

Clear Selection ignores the selected cells and **Cancel** returns you to the Data Review dialogue panel.

The **OK** button exits the Show Data panel, prompting the user to confirm that the rejected features should be deleted.

Once a feature and its data have been deleted it cannot be restored so make certain that the selection is correct before pressing the **OK** button. To exit without deleting any cells simply press the **Cancel** button.

The **OK** and **Cancel** functions can also be accessed from the menu bar at the top of the Data Review panel.

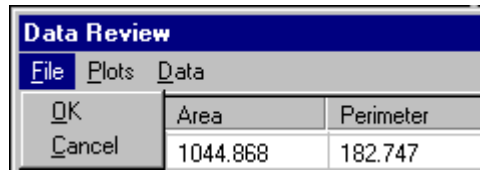

The **Save Data** button is used to save feature data to a results data file. Any cells that have been marked for deletion will not be included. The resulting data file can be read by standard spreadsheets such as Microsoft Excel.

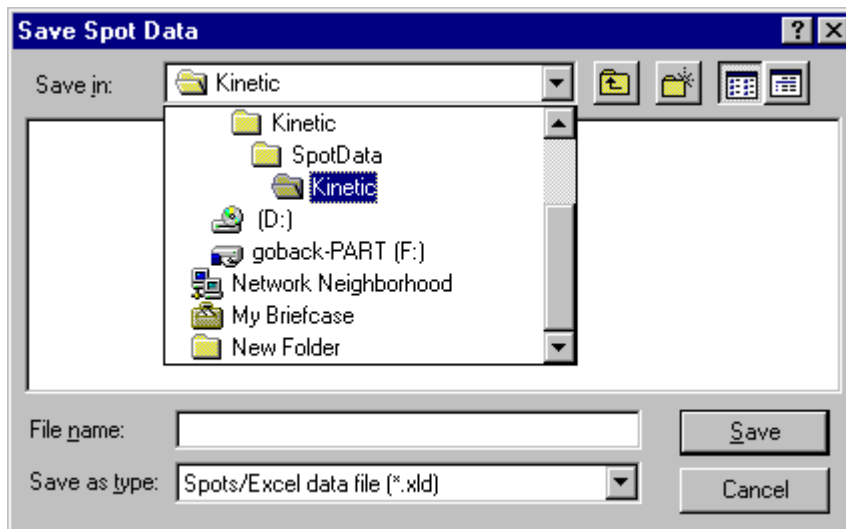

All the measured parameters specified previously for each feature are saved to the data file. The **Save Data** and **Clear Selection** options are also accessible from the menu bar.

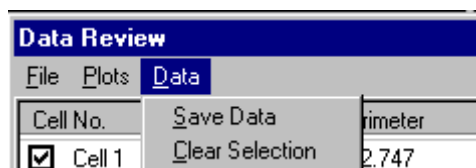

Feature selection for rejection is also used to determine which data to include for the plotting of histograms and scatter plots. Binned histograms can be plotted for any of the available cell parameters. For example, plotting cell-integrated intensity produces the typical Spot histogram. The histogram plotting function is accessible via the **Histogram** button or from the **Plots** option on the Data Review menu bar

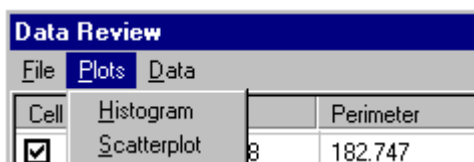

Similarly, scatter plots to compare any two cell parameters can also be plotted. The scatter plot chart function is accessible via the **Scatterplot** button or from the **Plots** option on the Data Review menu bar

The plotting of histograms and scatter plots is discussed in **Sections 5.7.6.3** and **5.7.6.4**, respectively.

5.7.6.2 Show Spot Gallery

This is a visual method of viewing data in which the spots previously analyzed are shown as an image gallery.

Clicking on the **Show Spots** button opens an Image Review window, which displays the quantified features (e.g. cells or cell nuclei) in the form of a gallery. There are up to 8 parameters displayed for each cell or cell nuclei as specified previously in the Review dialogue.

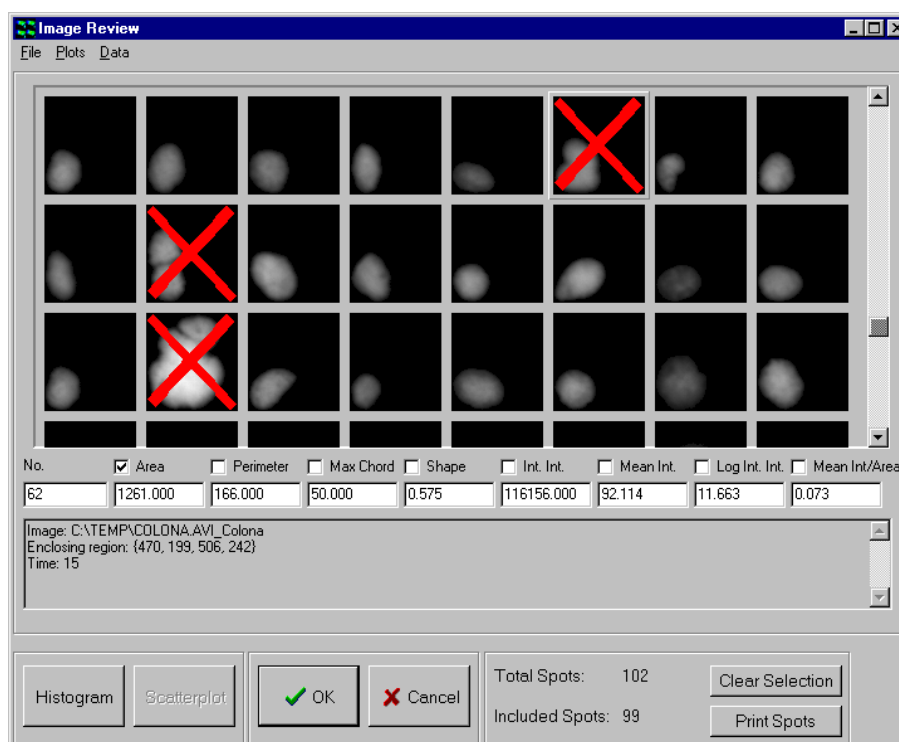

To display the data associated with a particular feature, click the left mouse button on the image to update the parameter text boxes. To remove an image from the data, double click on the image. The image will be tagged with a red cross, signifying that it is marked for deletion. A second double click on the cell will restore it to the data set, this will remove the cross tag from the image which will no longer be marked for deletion.

Binned histograms can be plotted for any of the available cell parameters. To plot a histogram, click the left mouse button once over the tick box next to the parameter name, so that a tick appears in the box, and then press the **Histogram** button. The histogram plot function can also be accessed from the menu bar at the top of the Image Review window.

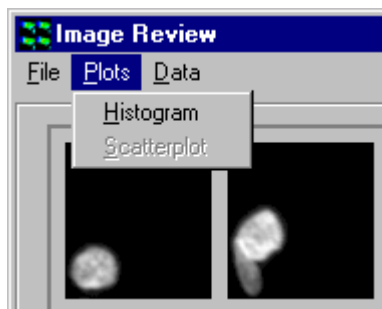

The use of the histogram dialogue is described in **Section 5.7.6.3**.

Note: To plot the histogram for a different cell parameter it is necessary to first click the left mouse button once over the first parameter tick box to remove the tick from the box.

Similarly, scatter plots to compare any two cell parameters can be plotted. To plot a scatter plot, ticks must be present in the tick boxes next to the two parameter names before pressing the **Scatterplot** button. The scatter plot function can also be accessed from the menu bar at the top of the Image Review window.

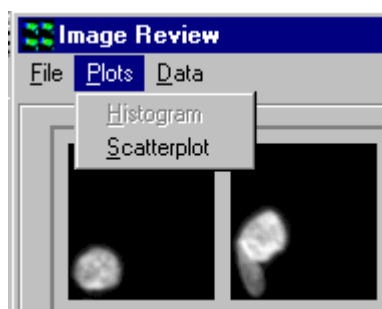

The use of the scatter plot dialogue is described in **Section 5.7.6.4**.

The **OK** button exits the Show Spots dialogue, first asking the user for confirmation to delete the cells marked for deletion. **Cancel** returns you to the Review panel dialogue.

These options can also be accessed from the menu bar as illustrated below.

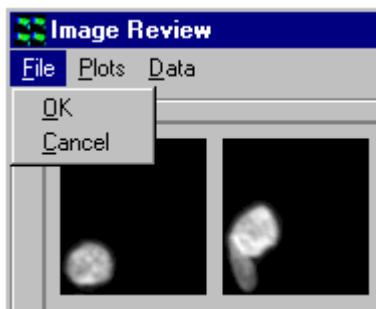

Clicking on the **Clear Selection** button ignores the selected cells removing all the red crosses from the image gallery.

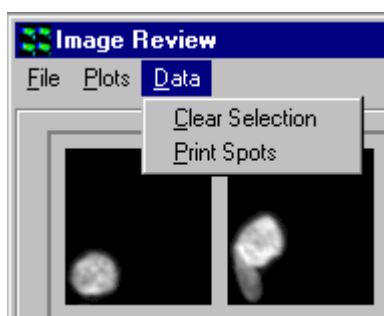

Clicking the **Print Spots** button allows the image gallery to be printed to enable a visual comparison of all detected features.

The print layout can be adjusted to specify the number of columns and rows in the printed page.

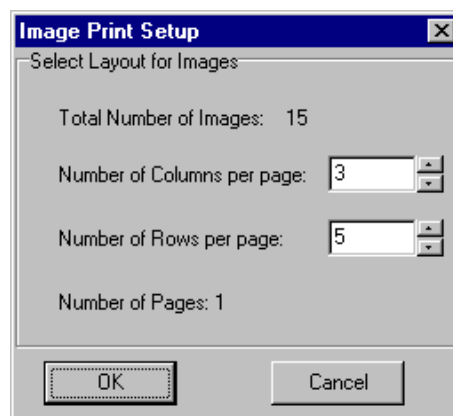

An example Print Preview window is shown below.

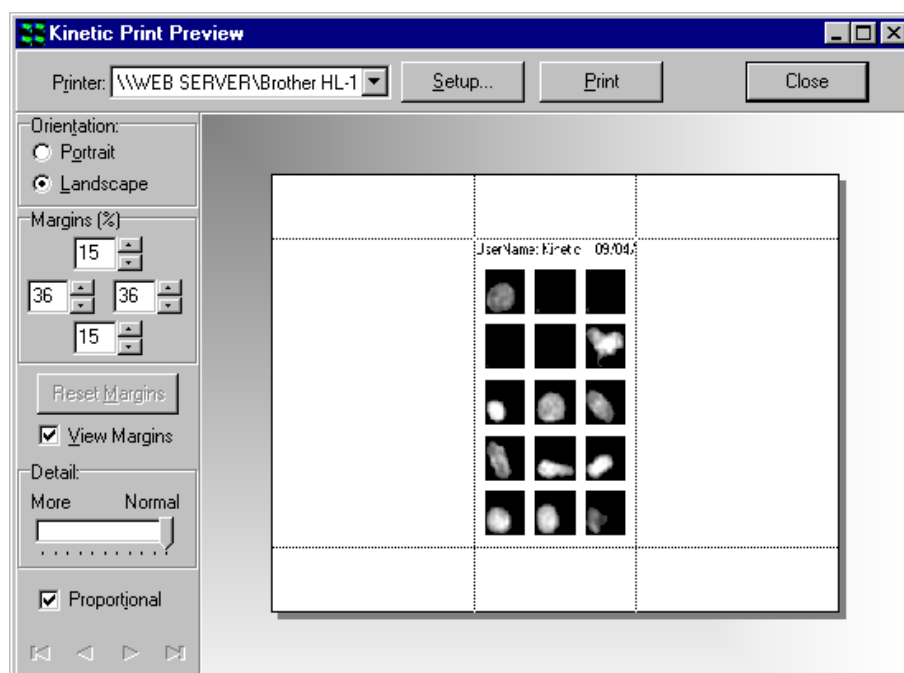

5.7.6.3 Histograms

To plot a histogram, click on the **Histogram** button or select the histogram plot function using the menu bar as shown previously. A parameter selection panel is displayed as shown below.

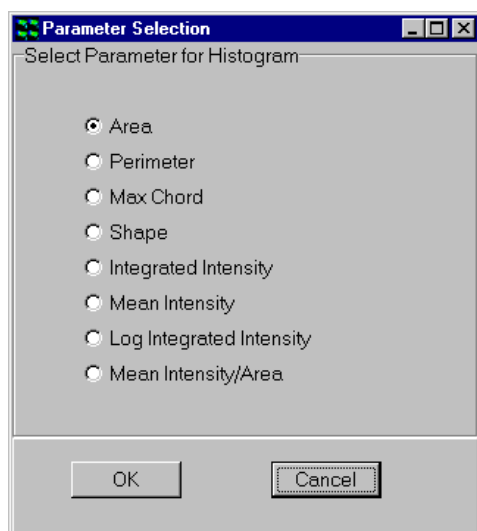

The parameter to be plotted in the histogram is selected by clicking on the appropriate radio button.

Clicking on the **Cancel** button exits the dialogue and returns to the Data Review panel.

Once the required parameter has been chosen, click on the **OK** button to continue.

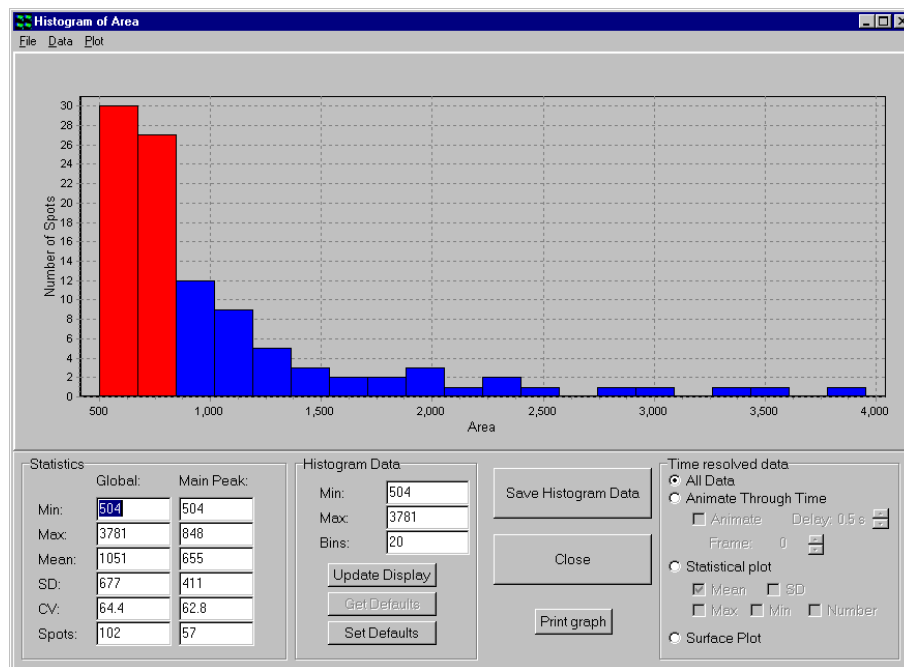

In the upper part of the panel a binned histogram of the chosen cell parameter is plotted. Statistics are displayed below the histogram plot on the left of the dialogue for the complete histogram and for the main peak bin (displayed on the histogram in red).

The minimum and maximum values to be displayed in the histogram can be specified in the Histogram Data section of the panel, together with the number of bins in the histogram, by typing appropriate values into the text boxes.

After changing one or more values, click on the **Update Display** button to update the histogram. If you wish to set the current values as the default values, click on the **Set Defaults** button. To reload the default values at a later date, click on the **Get Defaults** button.

To save the histogram data, (i.e. the number of cell nuclei in each histogram bin and the displayed histogram statistics) press the **Save Histogram Data** button.

A standard Windows Save File dialogue box is opened, which you can use to save the data in the usual manner. The data file can be read into standard spreadsheet programs such as Microsoft Excel.

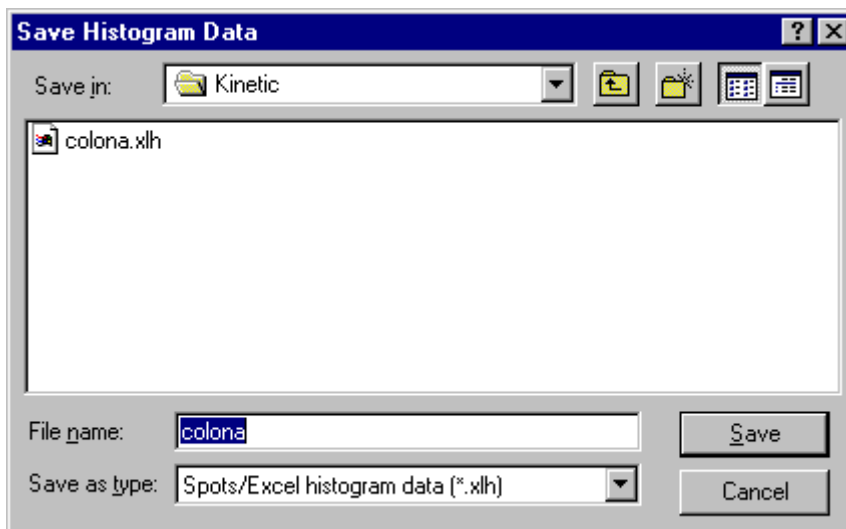

The **Print Graph** button enables the charted data to be printed for further inspection and comparison. An example Print Histogram window is illustrated below.

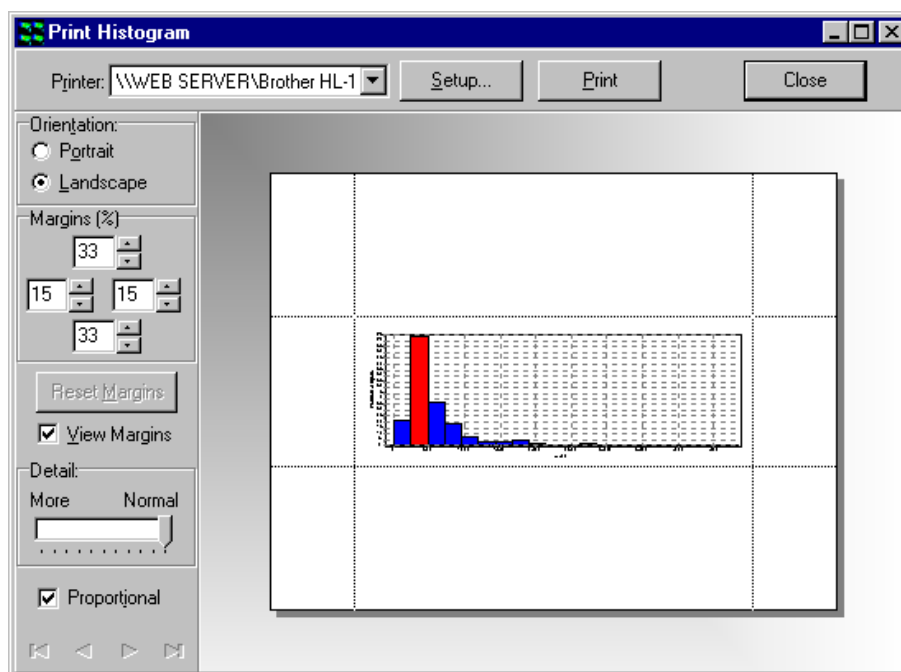

The **Save Histogram Data** and **Print Graph** functions are also accessible from the menu bar.

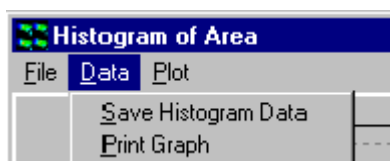

The **Close** button exits from the Histogram dialogue and returns to the Data Review

panel. This function is also accessible from the menu bar.

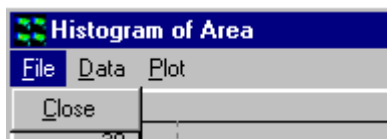

5.7.6.4 Scatter Plots and Editing

Scatter plots can be plotted for the comparison of any pair of feature parameters by clicking the **Scatterplot** button or accessing the function from the menu bar as described previously. Parameters to be plotted are selected by clicking on the appropriate radio buttons in the Parameter Selection window.

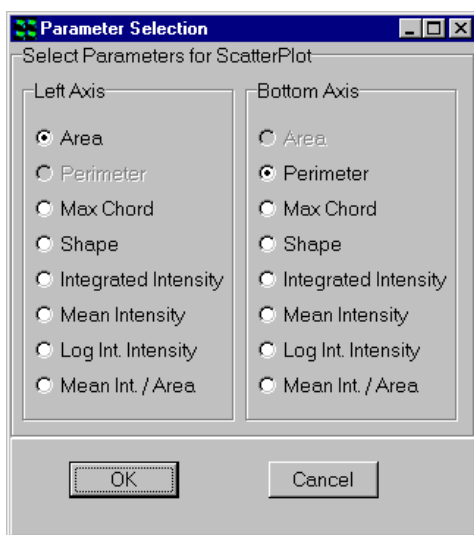

The resultant scatter plot is displayed after clicking the **OK** button.

An example scatter plot of Area Vs Integrated Intensity is shown below.

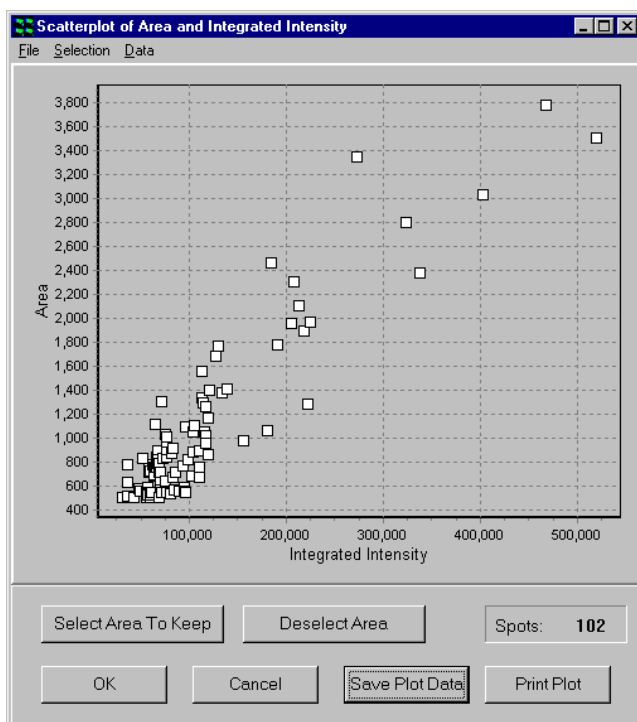

In the upper part of the dialogue box a Scatter Plot of the chosen cell parameters is plotted.

Clicking on the **Cancel** button exits the dialogue and returns to the Data Review panel.

The **Select Area** button enables the user to select an area or multiple areas from the scatter plot. If areas have been defined on the plot, any points not enclosed in these areas will be checked for deletion on exiting the Scatter Plot dialogue with the **OK** button.

The **OK** and **Cancel** functions are also accessible from the menu bar.

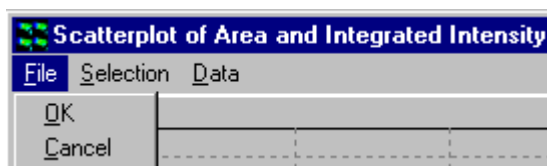

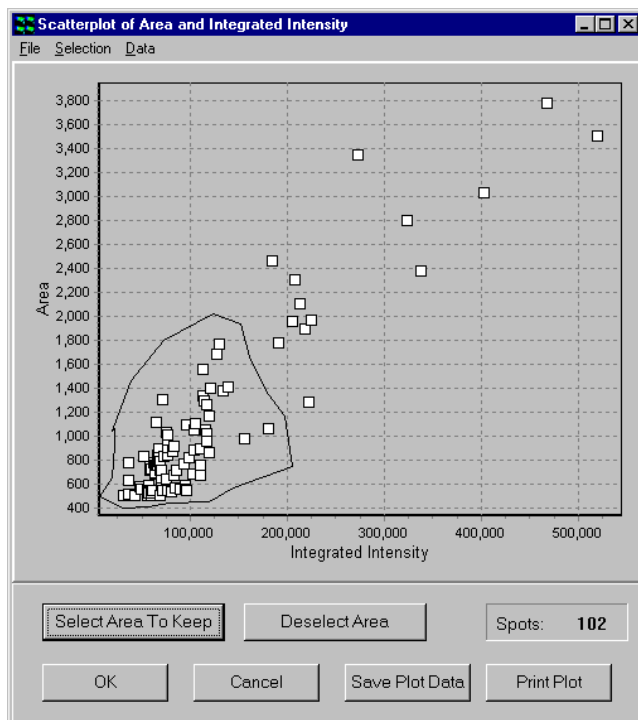

To define an area simply press **Select Area** so that the cursor changes in appearance, then using the left mouse button click once in the plot area, the next click will draw a line between these two points and so on. To close the area, press the **Right** mouse button.

The **Deselect Area** button will remove the areas from the scatter plot.

The **Select Area** and **Deselect Area** functions are also accessible from the menu bar.

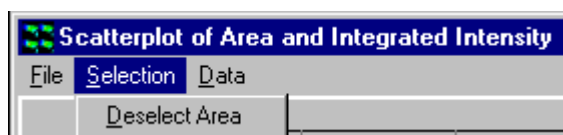

To save the Scatter Plot data, press the **Save Plot Data** button. A standard Windows Save File dialogue is opened, which you can use to save the data in the usual manner.

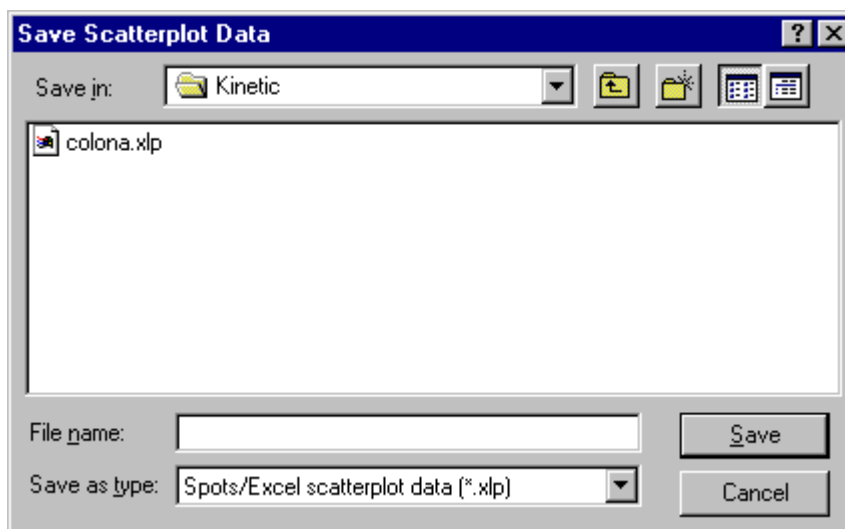

All the measured parameters specified previously in the Review panel corresponding to each data point in the scatter plot are saved to the data file.

The **Print Plot** button enables the scatter plot to be printed for further inspection and comparison. An example Print Plot window is illustrated below.

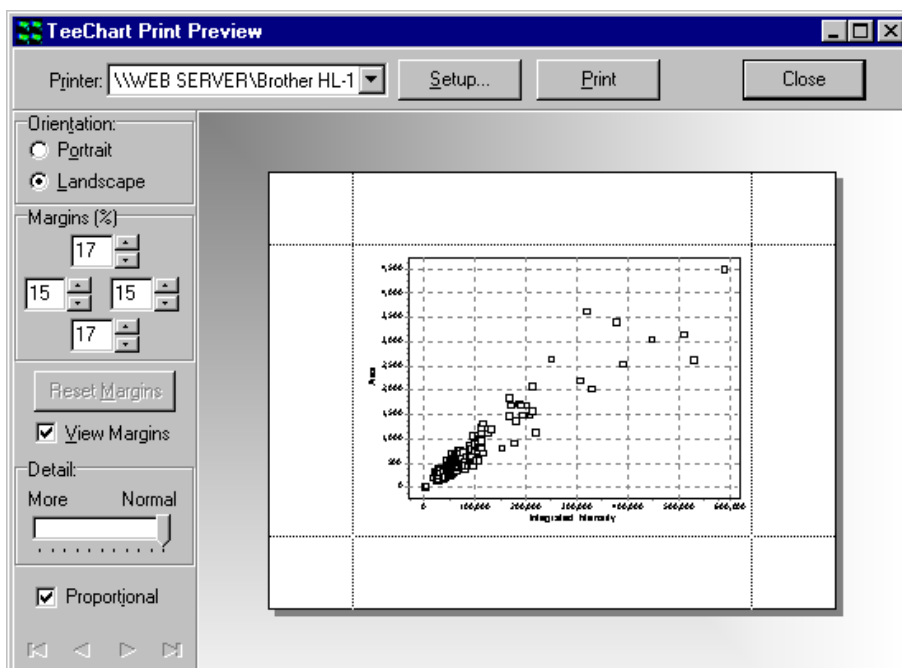

The **Save Plot Data** and **Print Plot** functions are also accessible from the menu bar.

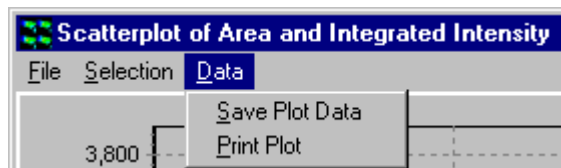

5.7.6.5 Show Images

The **Show Images** function enables features to be visualized together with their bounding rectangles and cell numbers assigned previously during quantification. This function is particularly useful for the analysis of temporal data where a significant change in spot characteristics may occur at a particular point in the time series.

Clicking on the **Show Images** button opens an Image Review window, which enables the selection of the required data set. A window following the analysis of an individual image is shown below.

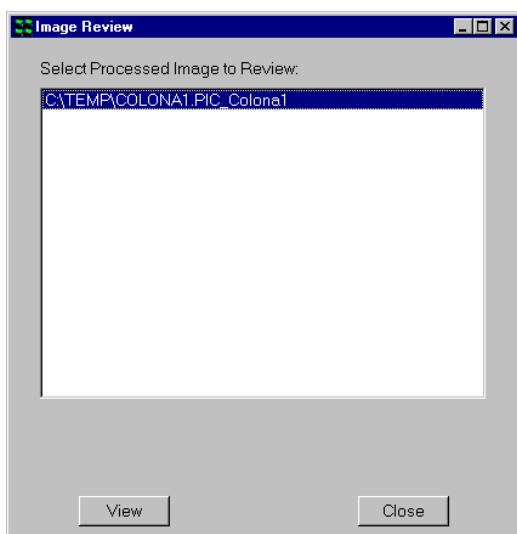

The appropriate image is selected by clicking on the file name with the left mouse button.

Clicking on the **View** button results in the display of the selected image in the Image Window. An example is shown over.

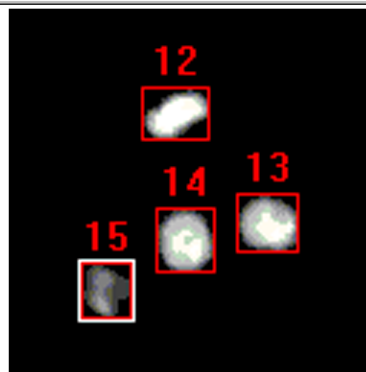
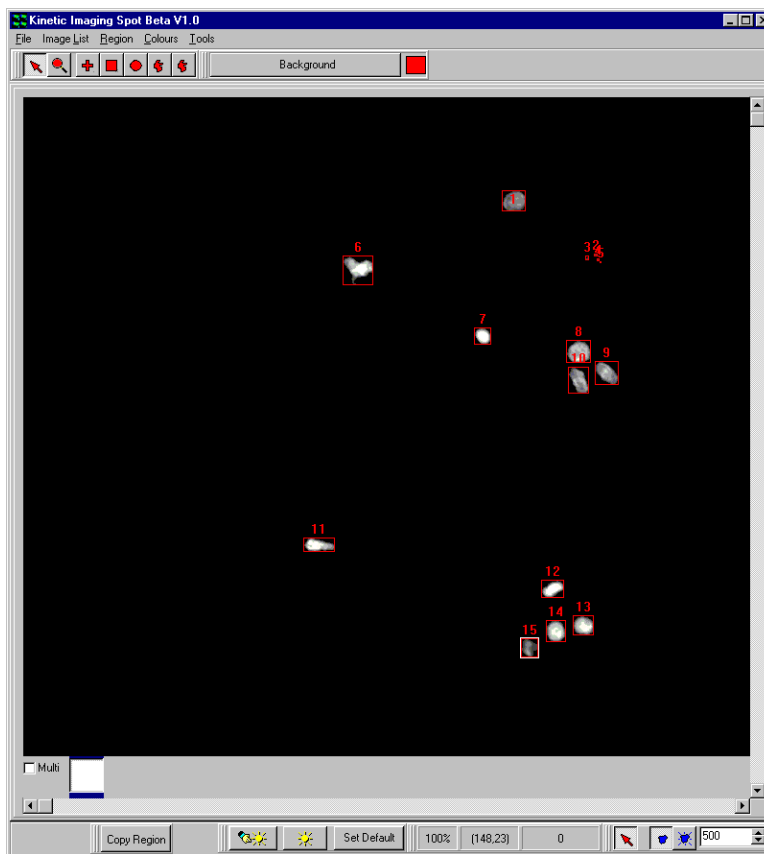

5.7.6.6 Clear Data

Clicking on the **Clear Data** button removes analysis data from memory following confirmation by the user.

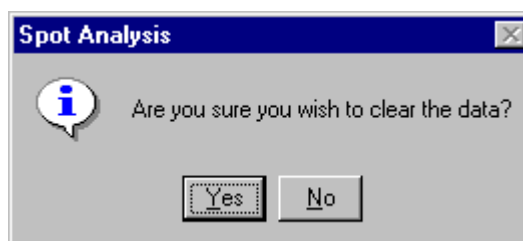

5.7.6.7 Save Data

The **Save Data** button is used to save feature data to a results data file.

5.7.7 Multi-frame or Time-Series Data

Additional functionality is available for the statistical analysis of time series data. Pressing the **Show Data** button displays the following data table.

Cell No.	Frame	Area	Perimeter	Max Chord	Shape	Int.Int.	Mean Int.	Log Int.Int.
Cell 1	0	552.000	110.000	31.000	0.573	70938.000	128.511	11.170
Cell 2	1	868.000	152.000	49.000	0.472	119806.000	138.025	11.694
Cell 3	1	591.000	118.000	36.000	0.533	94156.000	159.316	11.453
Cell 4	1	557.000	116.000	35.000	0.520	89870.000	161.346	11.406
Cell 5	2	570.000	116.000	35.000	0.532	83679.000	146.805	11.335
Cell 6	2	539.000	116.000	36.000	0.503	79624.000	147.725	11.285
Cell 7	2	689.000	144.000	41.000	0.418	102138.000	148.241	11.534
Cell 8	3	506.000	116.000	32.000	0.473	68472.000	135.320	11.134
Cell 9	4	821.000	136.000	41.000	0.558	98114.000	119.505	11.494
Cell 10	4	893.000	134.000	38.000	0.625	110248.000	123.458	11.610
Cell 11	4	513.000	110.000	34.000	0.533	42553.000	82.949	10.659
Cell 12	4	564.000	120.000	35.000	0.492	55622.000	98.621	10.926
Cell 13	4	551.000	110.000	31.000	0.572	56900.000	103.267	10.949
Cell 14	4	833.000	144.000	42.000	0.505	51479.000	61.800	10.849
Cell 15	4	729.000	122.000	37.000	0.615	59458.000	81.961	10.993
Cell 16	5	537.000	108.000	35.000	0.579	57259.000	106.628	10.955
Cell 17	6	554.000	110.000	36.000	0.575	75758.000	136.747	11.235

Cell No.	Frame	Area	Perimeter
Cell 1	0	552.000	110.000
Cell 2	1	868.000	152.000
Cell 3	1	591.000	118.000
Cell 4	1	557.000	116.000
Cell 5	2	570.000	116.000
Cell 6	2	539.000	116.000
Cell 7	2	689.000	144.000
Cell 8	3	506.000	116.000

The column Frame identifies the location of features analyzed in the temporal data series. A data table can be displayed for the complete data set or a single time point by selecting the All Data or Single Frame option using the appropriate radio button. The example above shows the complete data table for a twenty-frame time sequence.

Selection of data for the complete time series or a single time point can also be

accomplished using the **View** option on the menu bar.

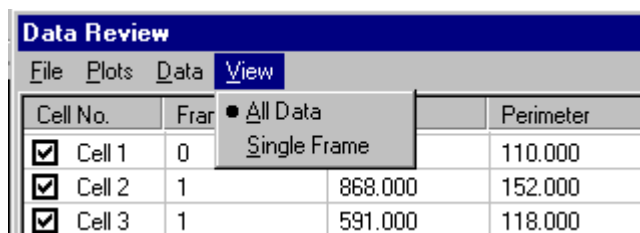

Selection of data corresponding to a single time point is illustrated below.

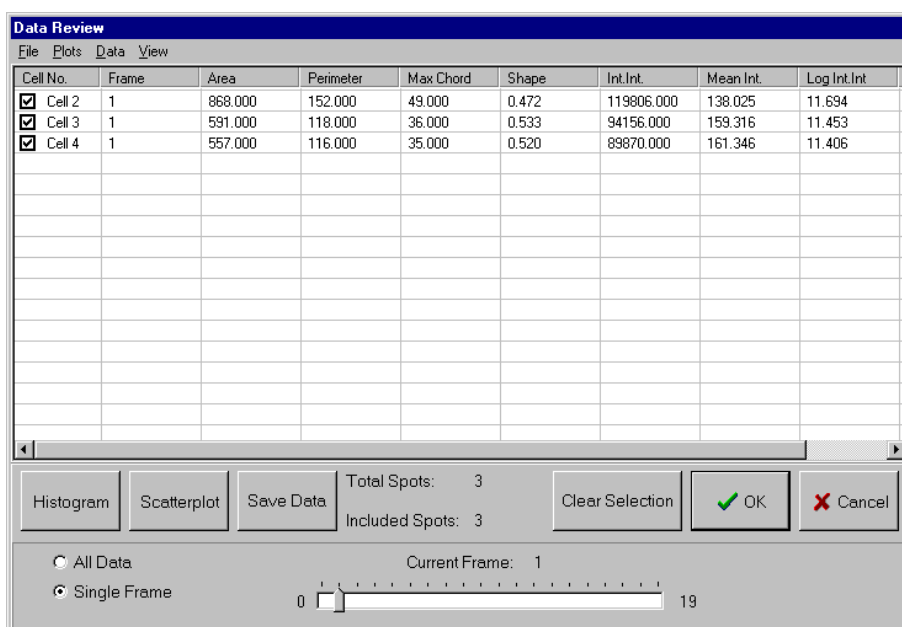

Data for the required frame is viewed by adjustment of the slider bar.

The functionality of the **Histogram**, **Scatterplot**, **Save Data**, **Clear Selection**, **OK** and **Cancel** buttons has been described previously in **Section 5.7.6.1**.

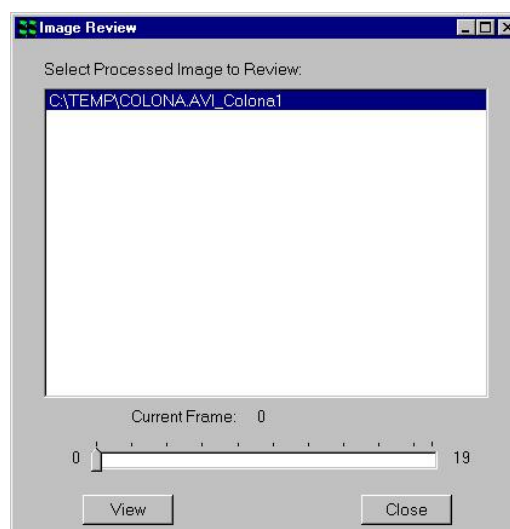

For a data set generated from a time series, the **Show Images** Image Review window appears as follows.

Individual features with their superimposed bounding rectangles and identification numbers can be visualized for any point in the time sequence by selecting the

appropriate frame using the slider bar and clicking the **View** button.

The **Close** button exits from the Show Images dialogue.

5.7.7.1 Dynamic Histograms

Additional functionality for the analysis of temporal data is provided within the Histogram plotting function.

To plot a histogram, click on the **Histogram** button and select a parameter to chart as described previously.

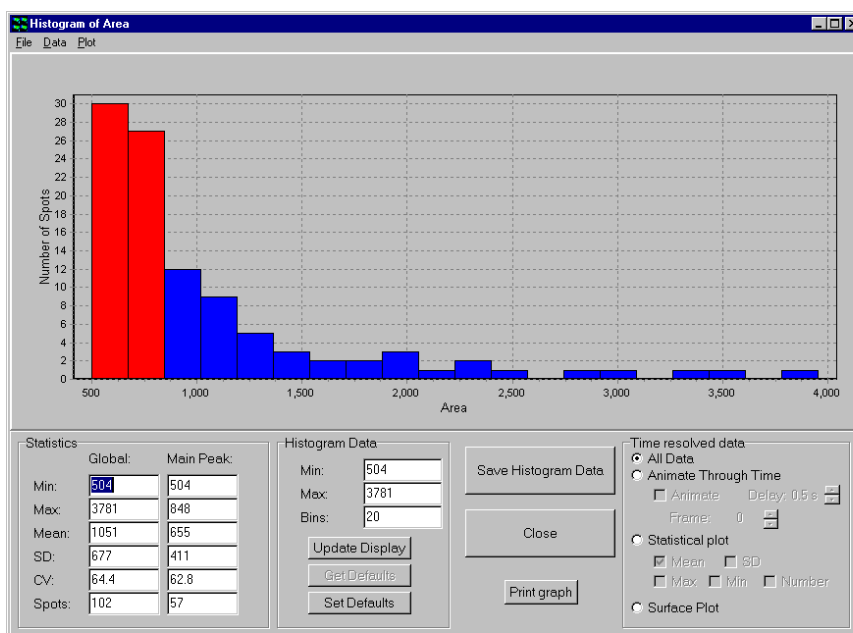

In addition to charting results for the whole data series, data from individual frames in a time series can also be visualized using the **Animate Through Time** option.

Variations in spot statistics over time may be visualized with the aid of the **Animate** check box, an appropriate speed for the animation selected using the **Delay** feature.

The animation function can also be accessed from the menu bar at the top of the histogram window via the **Plot** option.

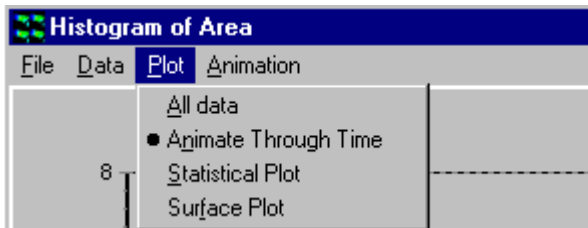

The Animation menu is used to toggle the animation on and off.

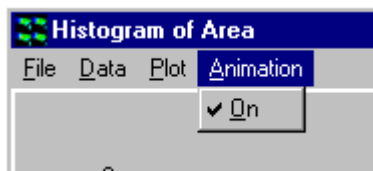

Results from any time point of interest can also be selected using the **Frame** spin buttons. A typical histogram from an individual time frame is shown below.

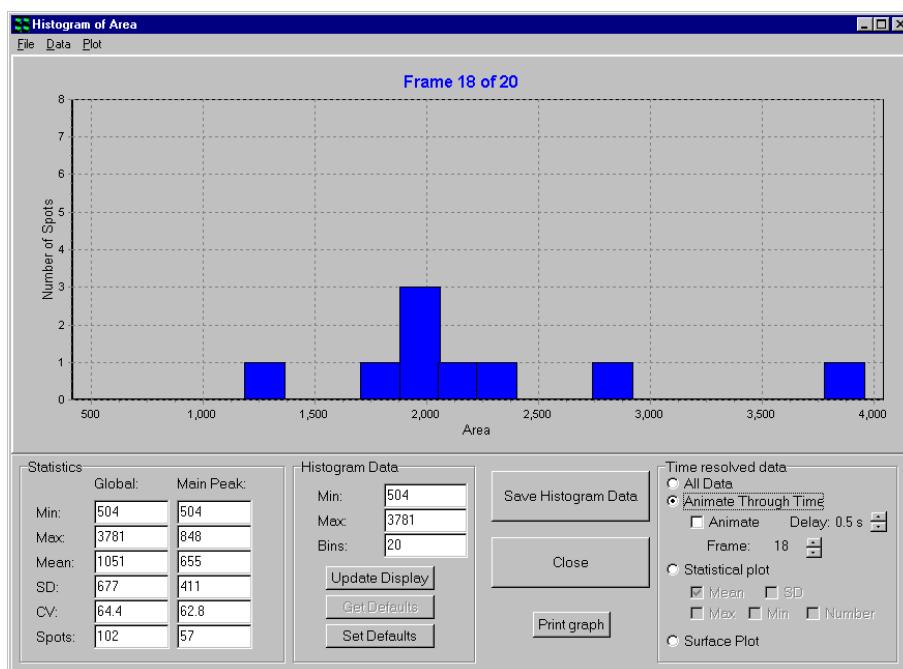

After changing Min, Max or the number of bins in the histogram, click on the **Update Display** button to update the histogram. If you wish to set the current values as the default values, click on the **Set Defaults** button. To reload the default values at a later date, click on the **Get Defaults** button.

The **Print Graph** button enables the displayed histogram to be printed for further inspection and comparison. An example Print Histogram window was shown

previously in this section.

When the **Save Histogram Data** button is pressed the number of features in each histogram bin for each time frame in the temporal data series is written to a data file together with a summary of the histogram statistics.

Save and Print functionality is also available from the menu bar as described previously.

5.7.7.2 Time-Series Plots

Clicking on the **Statistical Plot** button provides an alternative means of data presentation.

Mean, Min, Max and **SD** values can be plotted as a function of frame number. Charting the number of spots

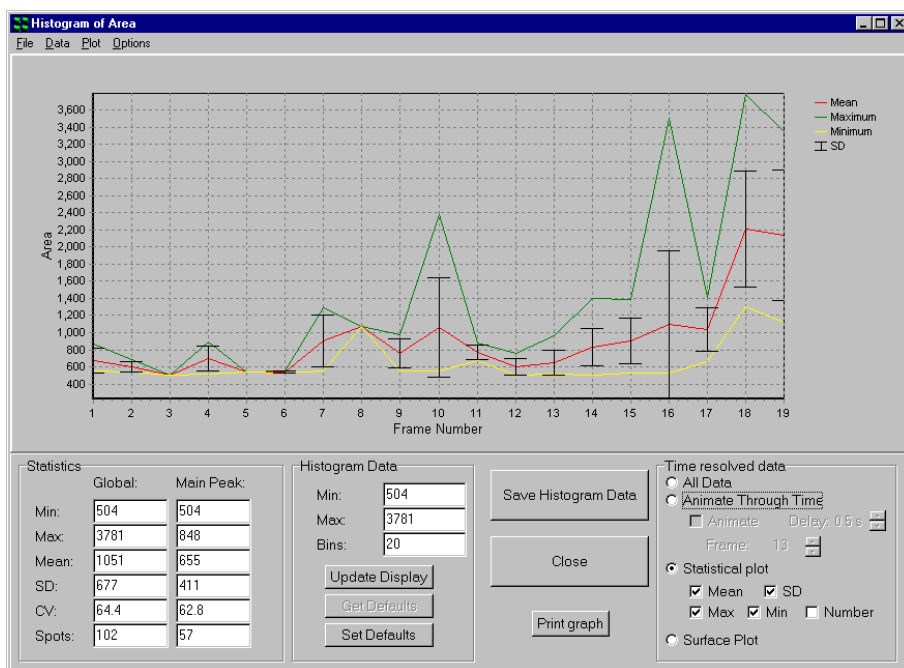

versus frame number is also possible by enabling the **Number** check box.

The Statistical Plot option can also be selected from the **Plot** menu and the parameters to be plotted selected from the **Options** menu.

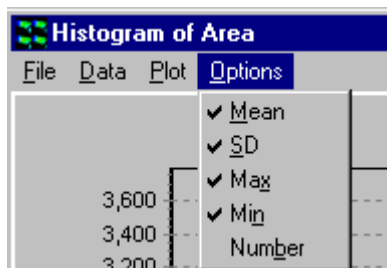
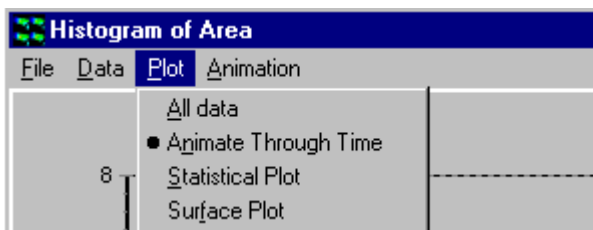

When the **Save Histogram Data** button is pressed the selected statistical parameters (e.g. Mean, SD, Max, Min and Number) are written to a data file together with a summary of the histogram statistics.

The **Print Graph** button enables the displayed statistical plot to be printed for further inspection and comparison. An example Print Histogram window is illustrated below.

Save and Print functionality is also available from the menu bar as described previously.

The example shows a plot for mean feature area for a time series comprising twenty time points.

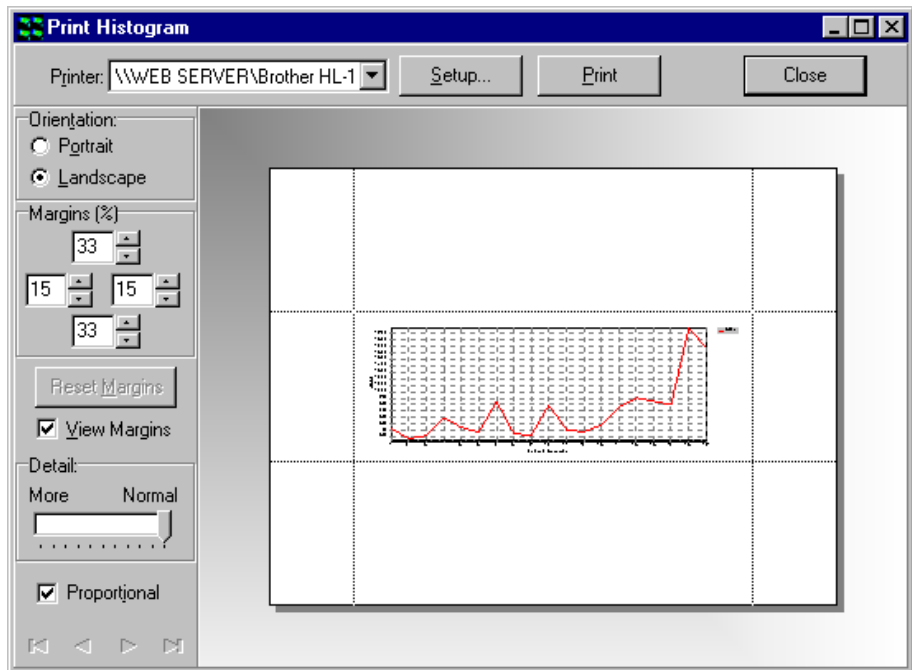

Clicking the Surface Plot radio button produces a 3 dimensional representation of the analysis data for the experimental parameter chosen previously in the Parameter Selection window.

The Surface Plot option can also be selected from the **Plot** menu.

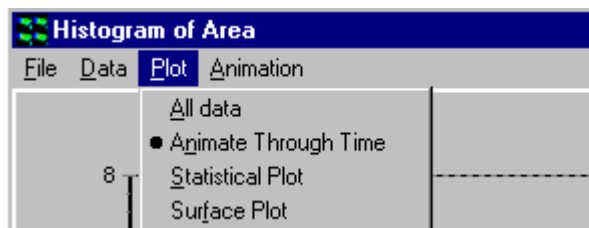

An example plot is shown below, feature areas measured for a twenty-point time sequence.

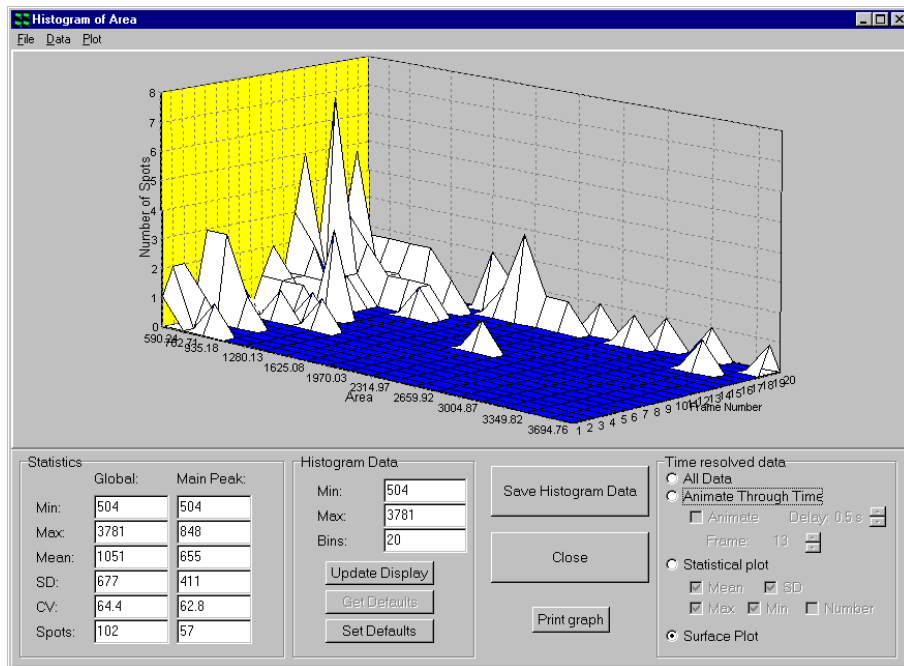

The orientation of the chart object in the display window can be adjusted by clicking on it using the left mouse button and dragging it to the required position.

When the **Save Histogram Data** button is pressed the raw data corresponding to each time point is written to an Excel compatible data file.

The **Print Graph** button enables the displayed surface plot to be printed for further inspection and comparison. Details of the save and print functions were described previously in this section.

5.8 Kymograph

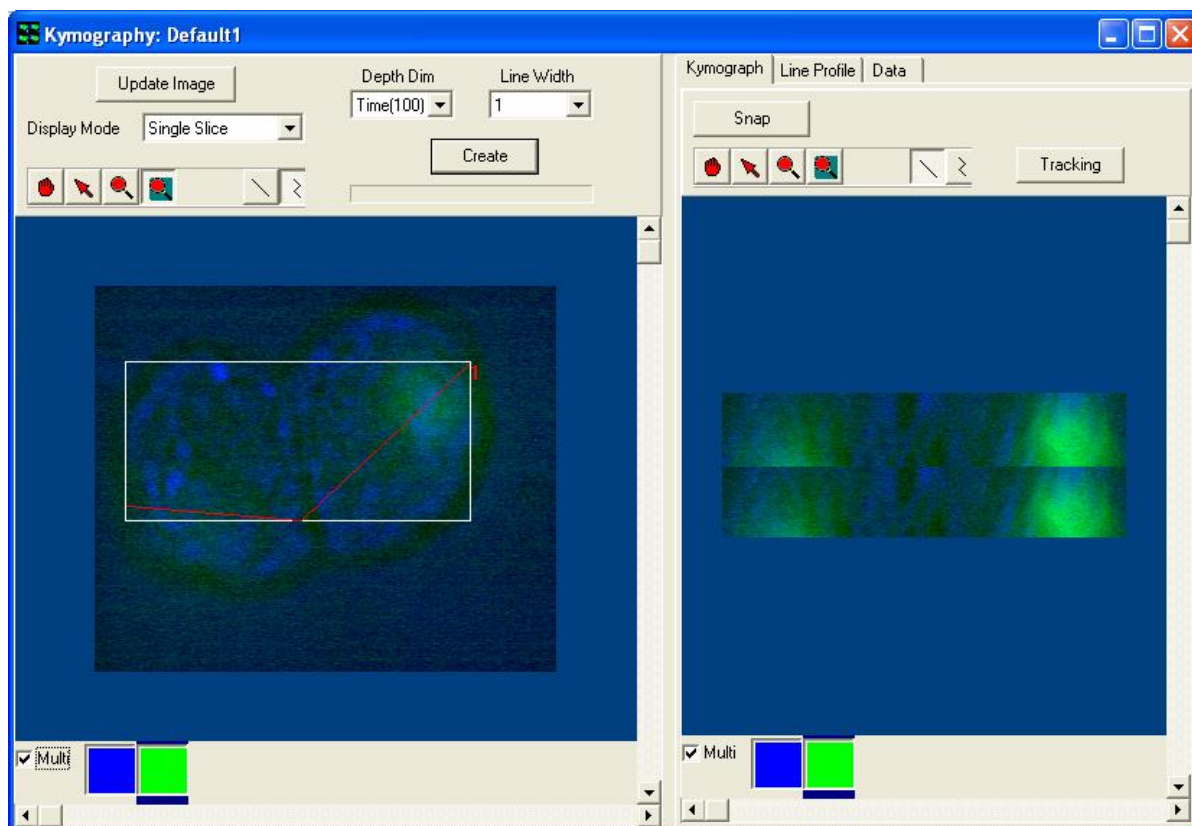

The **Kymography** Window is opened by selecting Kymograph from the View Menu at the top of the Image Window. Two windows will appear as seen in the above picture. The left side is the current image with a polyline and the right side is the actual Kymograph.

5.8.1 Creating a Kymograph

Once open, a line or polyline must be drawn on the image using the appropriate button from the tool bar. Press the **Update Image** to provide the most recent image.



Select the Depth Dimension and Line Width from the corresponding drop down list. Next Select the Display Mode from the dropdown list. Once satisfied with the image,

press the Create button. The status bar (located under the create button) will show processing activity.

5.8.2 Kymograph Results Window

Once completed the right side of the Kymography Window will display the results in three different formats: Kymograph, Line Profile and Plotted Data. Click on the corresponding tab to view the results.

5.8.2.1 The Kymograph Tab

The Kymograph Tab shows the changes in relation to the line selected.

Press the **Snap** button to snap a new image.

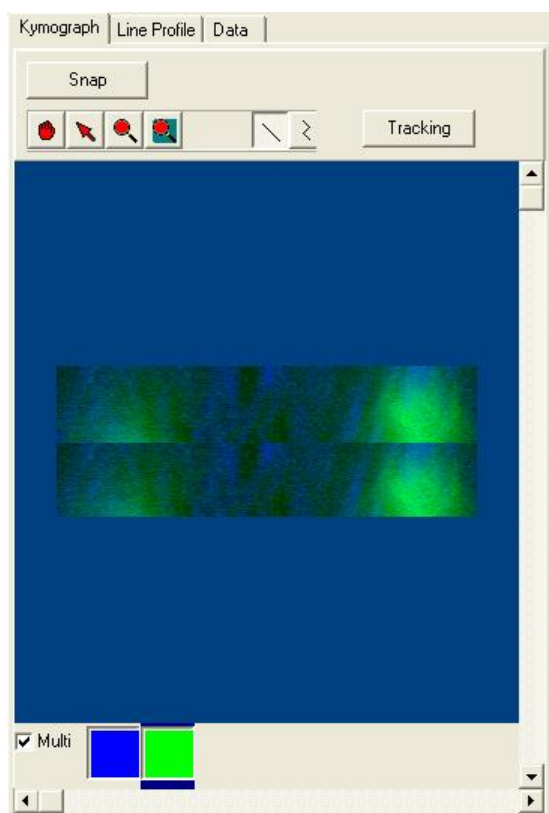

Press the **Tracking** button to track the plots through the series.

The user can look at multiple channels at one time as shown in this example or look at single channels. To look at a single channel simply select one of the colored boxes (relating to the palate chosen for that particular channel).

5.8.2.2 The Line Profile Tab

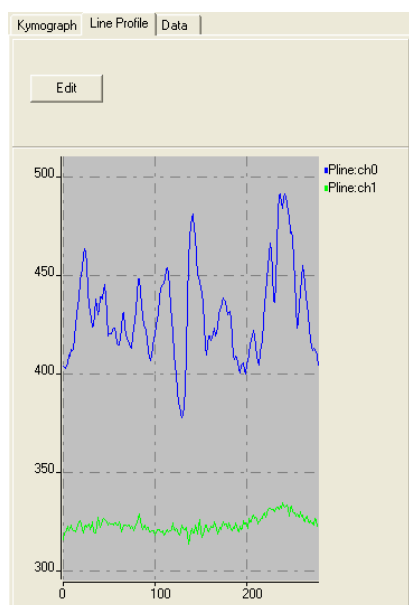

The Line Profile Tab shows the plotted line through the Kymograph. In this case both channels are plotted. Selecting the Edit button will open two options. Only the profile of the first image in the sequence is shown.

Scaling – Highlighting **Scaling** will give the user the options of Auto, Manual or Full Range. Select the appropriate option to apply to image.

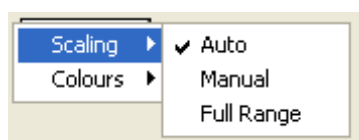

Colours–Highlighting **Colours** will give the following options. Select the option to apply to image.



5.8.2.3 The Data Tab

The Data Tab shows the Profile and Tracking Data. The Save Profile/Tracking Data button can be used to save the results in an (*.XLD) format.

*.XLD format is term we use for a text based format where tabs are used as field separators in the data. It can be easily read into Excel, Origin and other spreadsheet and graphing tools.

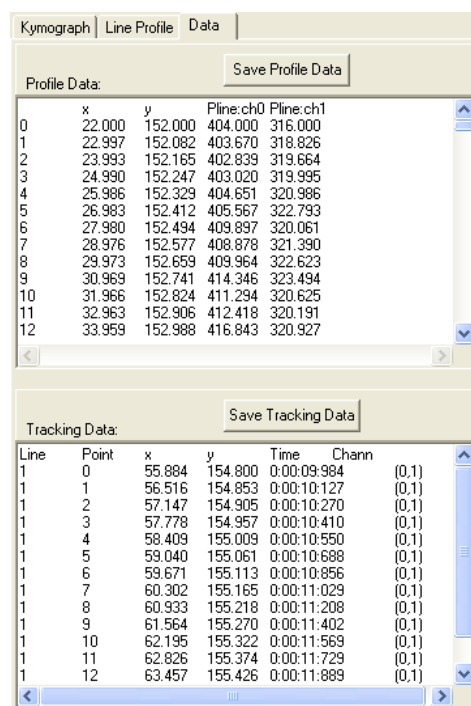
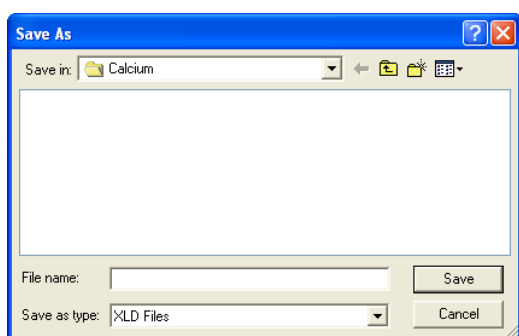

5.8.3 Lamella Mode in the Kymograph Plugin

Lamella mode operation is aimed at quantitative analysis of lamella protrusion and contraction observed in membrane ruffling, which is common in motile cells. It's development was suggested by a number of users and is based on the work Hinz et al (1999). But Kymography in general can be used in a number of different scenarios for quantification and visualization of movements, wavefront development, crystallization and so forth.

5.8.3.1 Step by Step Use of Lamella Mode

1. Load or show an image from the ImageList into iQ's Image Window. The image must be a series with a dimension in which analysis is possible e.g. Time or Z or even spectra can be analysed. In this case let us assume time is of interest as in lamella dynamics. In the work of Hinz et al phase contrast images were used, but fluorescence can also provide a suitable image data.

2. Start the Kymograph tool.

3. At the top-right of the Kymograph window select from the "Kymograph Mode" combo box "Lamella" as indicated by the arrow in the figure below on the left



4. At the top-middle of the Kymograph window select from the "Depth Dim" combo box "Time" as indicated by the arrow in the figure above on the right

5. It may be easier to see all changes that happened to the cell or membrane during acquisition time by displaying the source image in "Maximum Intensity Projection" (fluorescence) or "Minimum Intensity Projection" (phase/DIC) mode. Try using these modes with your data. Note: some LUTs will provide better contrast than others.

6. To start the analysis process, select the Point (Cross) button from the tool bar. Place a cross to mark the centre of the cell you are interested in.

7. From the tool bar, press the Line button and draw several lines from the centre of the cell to the outside region of the cell radially, as shown in the figure below. The direction of drawing is important as the Kymograph will reflect the start to end direction of the line when created. Try to make the line perpendicular to the features you wish to analyse.

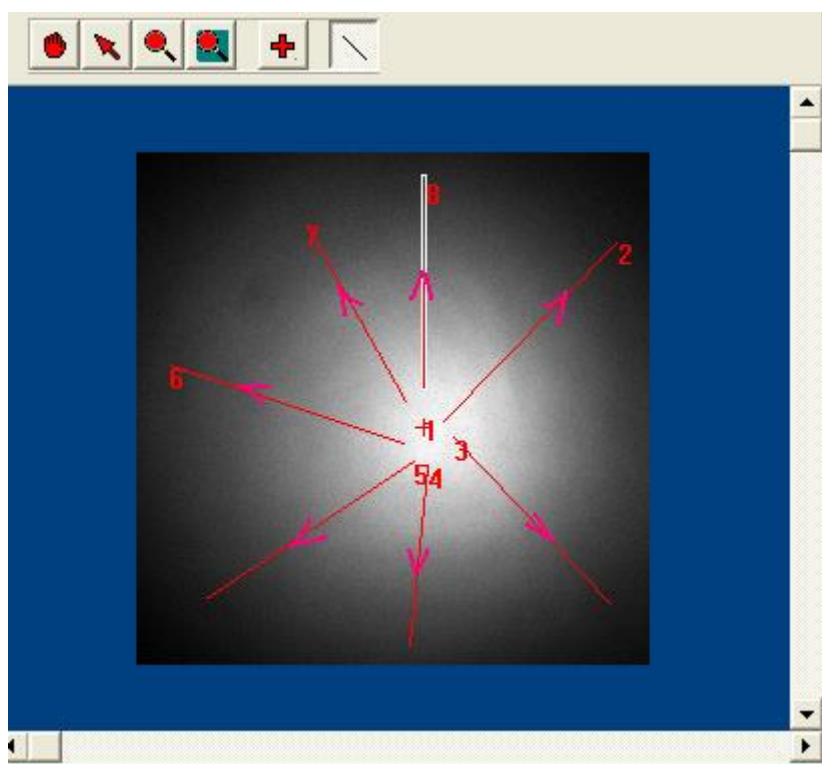

8. Clicking on the “Create” button will generate a Kymograph-Lamella image and display it in the right pane, as shown in the figure below.

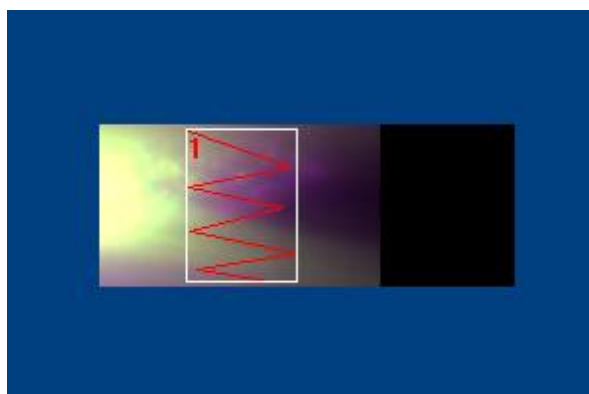

9. If you have drawn more than one line, there will be a scroll bar in the controls region at the top of the RH panel. Scrolling will show the kymographs corresponding to the lines drawn on the cell in the source image.

10. To start analysing the protrusion/contraction rates, select the Poly-line tool and draw some zig-zag lines to mark out the contraction and protrusion of the cell

membrane, according to your judgement . We call this “tracing” the time profile. (The figure is not a good example of this process, it is included for illustration purposes only).

11. When you have traced the time profile of interest, click the “Tracking” button and the data tab will display information as shown below:

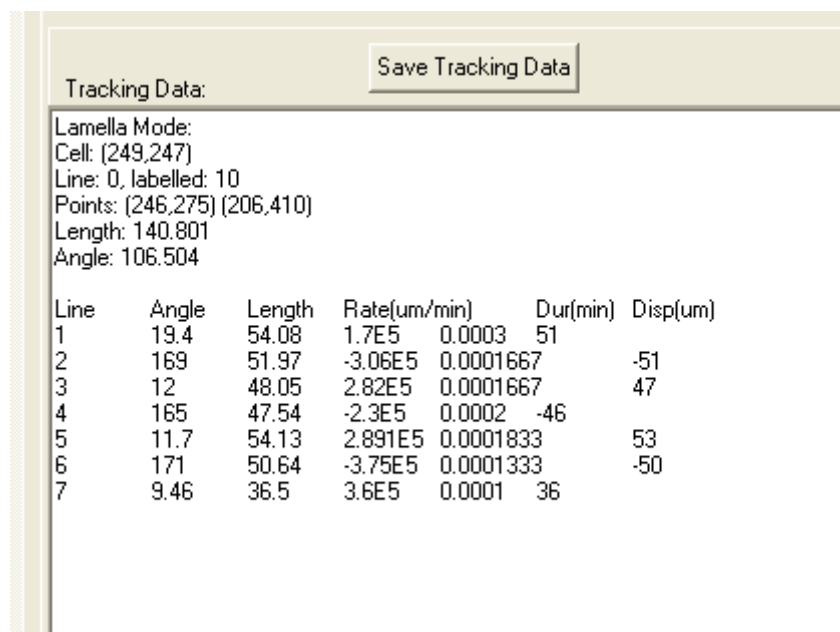

Line	Angle	Length	Rate(um/min)	Dur(min)	Disp(um)
1	19.4	54.08	1.7E5	0.0003	51
2	169	51.97	-3.06E5	0.0001667	-51
3	12	48.05	2.82E5	0.0001667	47
4	165	47.54	-2.3E5	0.0002	-46
5	11.7	54.13	2.891E5	0.0001833	53
6	171	50.64	-3.75E5	0.0001333	-50
7	9.46	36.5	3.6E5	0.0001	36

12. The rate and displacement have both positive and negative values, positive being protrusion and negative contraction.

13. You can repeat this process for all of the lines in the source data. Each line will deliver a data set like the one above showing protrusion and contraction rates and will be recorded for a Cell and the cell is identified by the Cross coordinates.

14. There is one known problem with Lamella mode. This does not cause a crash or a malfunction, but does create an error message whenever the Right Mouse “Delete” or Delete All” operation which is used. This is the only way to remove and redraw lines for analysis. All you have to do is click on OK when the error message shows and the Kymograph PlugIn will recover and continue. This will be fixed in a future release.

Reference

Hinz, B., Alt, W., Johnen, C., Herzog, V., Kaiser, H-W., “Quantifying Lamella Dynamics of Cultured Cells by SACED, a New Computer-Assisted Motion Analysis”, *Experimental Cell Research* **251**, 234–243 (1999)

Article ID excr.1999.4541, available online at <http://www.idealibrary.com>

5.9 Orthogonal Slice View

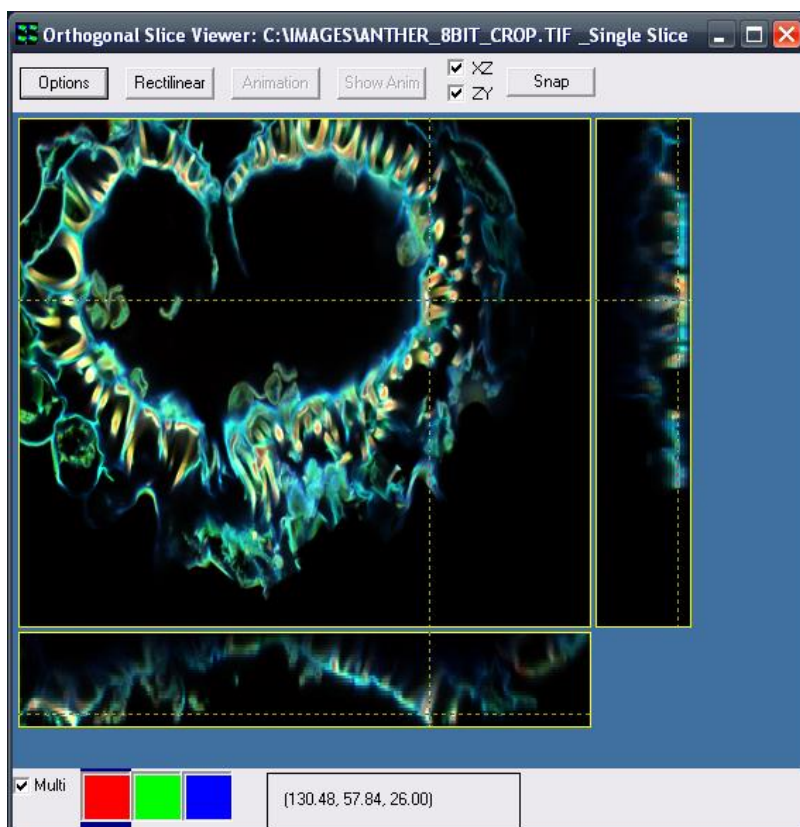

The Orthogonal Slice View Window is opened when **Orthogonal Slice View** is selected in the Image Window Tools Menu. Once opened, the Orthogonal Slice View Window will display three orthogonal views of a selected point on the current image. The main part of the image displays the current XY section. For a multi-dimensional image containing a third

dimension (e.g. Z), moving the crosshairs to a point on the image will display a ZY slice to the right of the image and a XZ slice below the image. The coordinates of the position of the crosshairs are indicated in a box at the bottom of the viewer.

The visibility of the XZ and ZY slices is controlled by checking or unchecking the corresponding boxes at the top of the viewer. The view can be mapped by clicking the manual mapping icon and adjusting the parameters as described previously in **Section 5.2**. In addition the Automap button at the bottom of the Image Window can be used. You will need to click on the Orthogonal Slice View Window to update the view with the newly selected mapping parameters.

Clicking on the **Options** button opens the Render Options panel shown below.

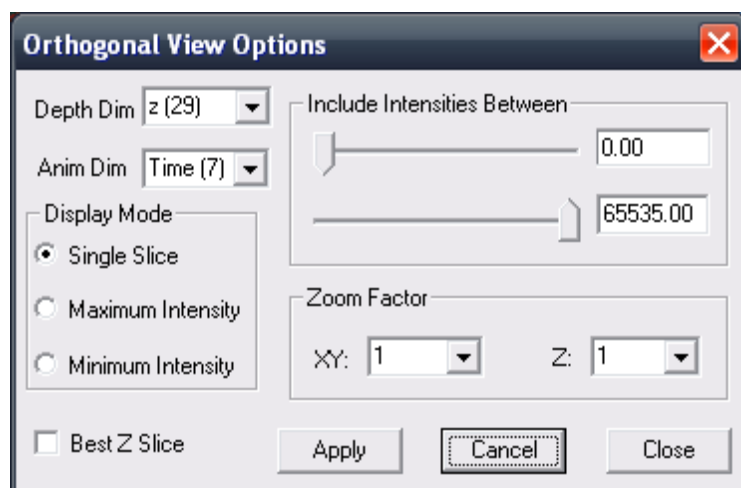

Depth Dim: you can choose which dimension to use as the third dimension for the orthogonal rendering.

Anim Dim: you can choose which dimension to use as the animation dimension

Display Mode: gives you several choices, such as: Single Slice, Maximum Intensity and Minimum Intensity.

Render Methods - Single Slice gives a map of the points that appear at the position selected by the crosshairs while Maximum Intensity and Minimum Intensity give a two dimensional projection of the maximum or minimum intensities along the lines of view through the volume.

Include Intensities Between: this has two scrollbars that you can use to select the range of intensities for rendering.

Zoom Factor: this allows you to change the zoom along all XY and Z axis.

Best Z Slice: checking it will allow the orthogonal view to select automatically the nearest Z slice to the focus during the creation of the animation independently for each time point.

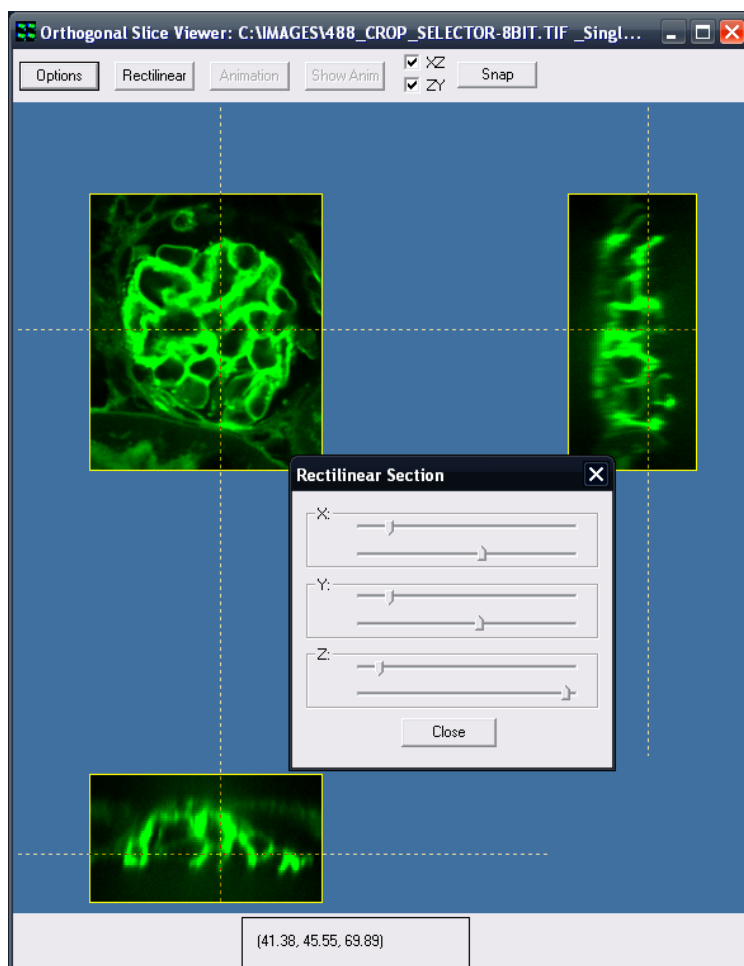

Clicking on the **Rectilinear** button opens a panel that gives you the possibility to select a 3D ROI (X, Y and Z) of the rendered image.

With an image containing enough dimensions, it is possible to create an animation of the orthogonal slices. Clicking the **Animation** button generates a new image containing the orthogonal slices for all time points. The animation dimension can be selected in the option panel. All currently applied settings will be used to generate the animation (rectilinear section, display mode, intensities inclusion, zoom factor and best z slice). A window appears during the process to indicate the progress of the creation of the animation. Once the animation is finished, clicking the **Show Anim** button will show the newly created image in the Image window.

The **Snap** button takes a snap of the currently shown orthogonal slices.

5.10 The Strip View Tool

The StripView tool is accessed from the Image Window View menu and is included to provide another way of viewing multi-dimensional data. In the Strip View you can create a view of a time or z-sequence as if it were in a physical film strip which if used for projection would show a movie. Examples are shown below for both time series and Z series data.

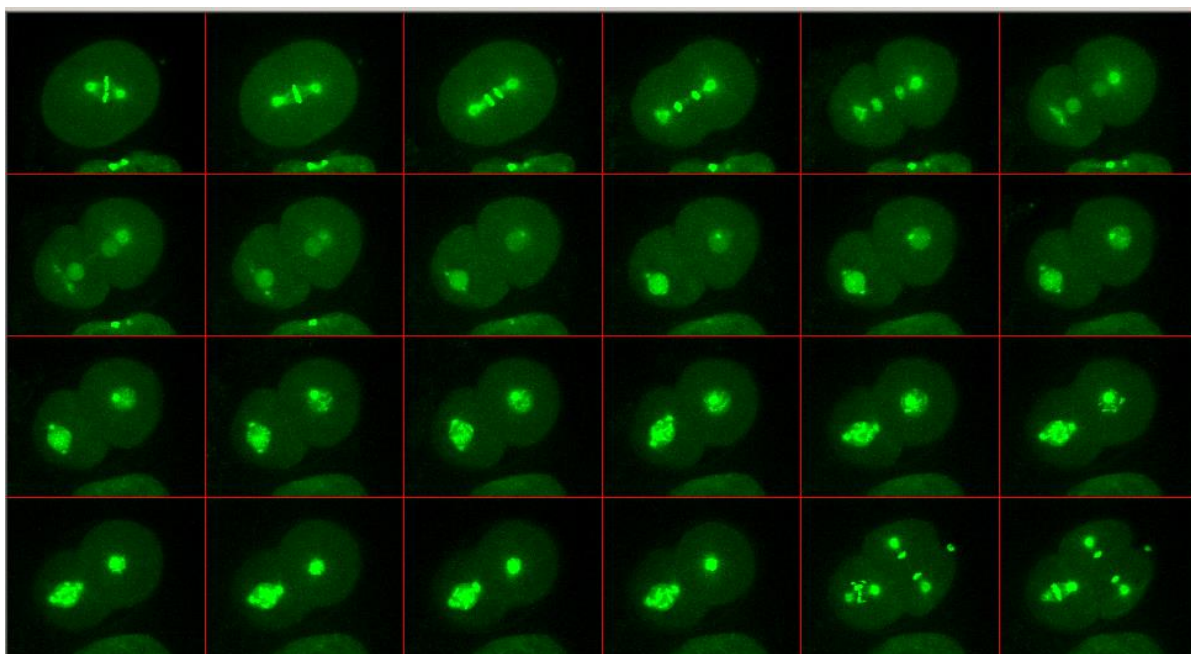

The first file strip shows early embryonic development of a nematode, *C. Elegans*, over a time period of a few tens of minutes, with key frames chosen to illustrate a specific point. The original 4D data was acquired with an Andor Revolution XD system and the result above shows a maximum intensity projection at each time point through the series.

The Strip View below shows a time series of cultured cells during a laser ablation experiment at the region defined by the red circle in the top left of the image frames. A 350 nm, 3ns, 12 uJ pulse is delivered to the specimen between frames 29 and 30. When observed in a movie, there is significant relaxation of local filaments and cellular junctions after ablation.

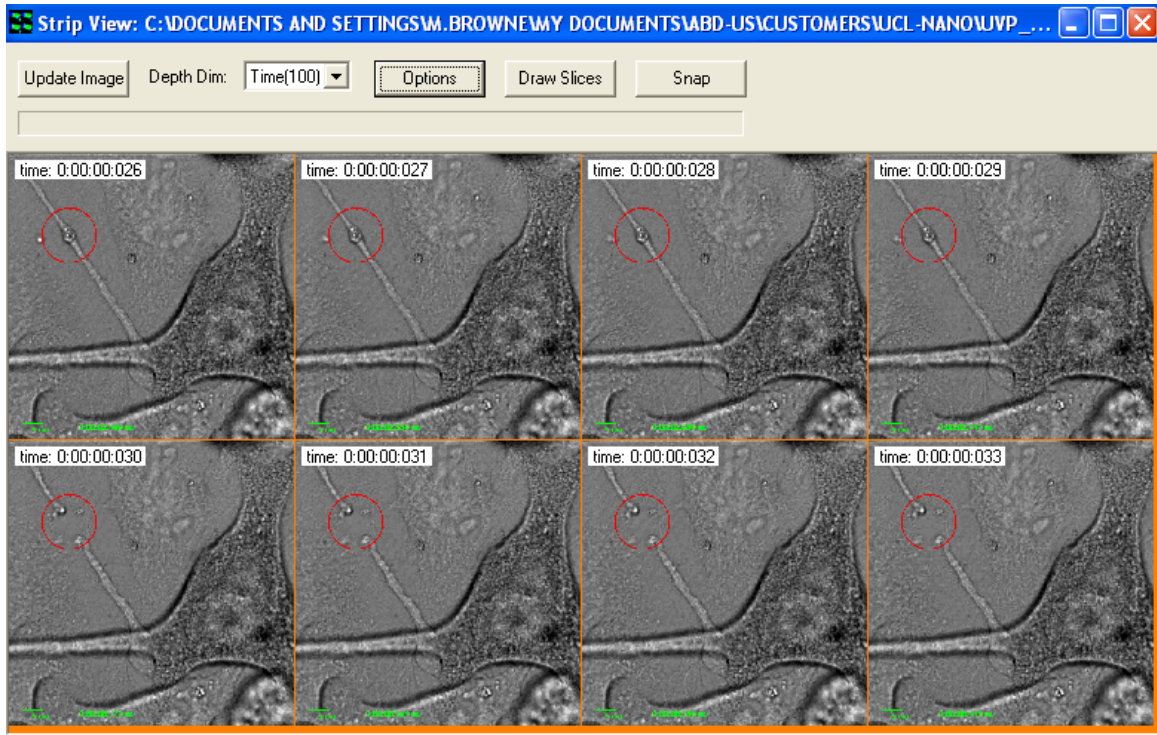

5.10.1 Strip View Options

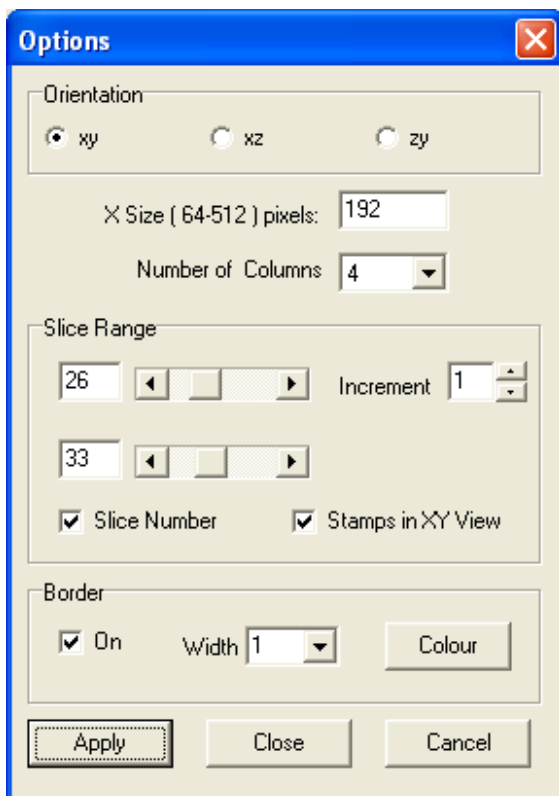

Using the interactive dialogs – above and left - you can choose the dimension in which you wish to iterate (in this case Time) and the start and end frames and frame interval to be rendered. You can choose the size of each frame and the number of columns in the rendered frame matrix. You can choose to show the dimension stamp – this sequence shows frames 26-33 in a 4x2 image matrix and the frame number is shown as an overlay on each image frame. The background color (orange in this case) can be user defined click on the Colour button as well as Border width separating each frame.

The Film Strip can be recorded as a full dynamic range image in iQ by clicking on

the Snap button at the top right of the Strip View dialog. For best presentation quality, keeping the border color and dimension stamp information, you should use the Alt-PrintScreen key combination. This will place the bitmap image into Windows Clipboard so that it can be pasted into your presentation directly or into a graphics application e.g. Windows™ Paint for saving as JPG or similar format.

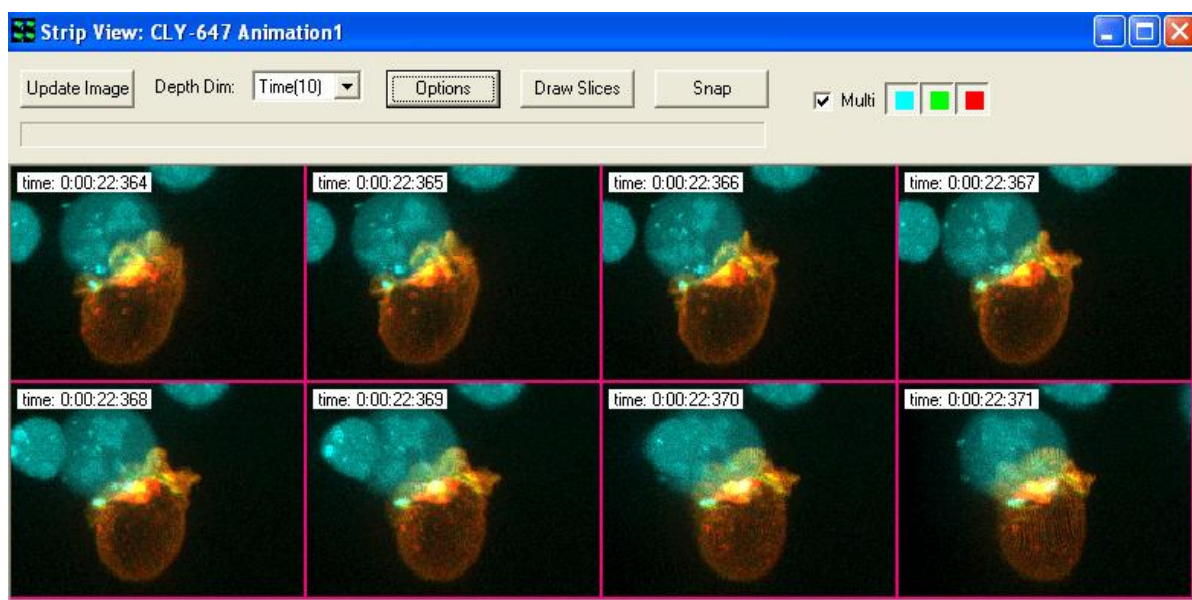

Strip View of an animation produced by FastMIP the OpenGL maximum intensity projection Viewer described in the next section. Where movies are not suitable for presentation then Strip View provides another means and can be helpful in explaining the unfolding of events.

5.11 The FastMIP and 4D View

The FastMIP tool is accessed from the Image Window and has its own high level Menu item for direct access. FastMIP uses OpenGL to provide maximum intensity projection (MIP) views of 3D, 4D and 5D data during or after acquisition. We use the term Fast because we rely on hardware performance for rapid rendering and also because we only load the head on (XY) view of the image data. The result is that FastMIP can provide a rapid “validation” of experimental progress, while having little impact on acquisition performance. The Viewer is multi-threaded to minimize impact on other processes. An example of FastMIP at work is shown below with a 4D multi-channel data set. Note, in 4D, a Navigator allows playback through time to observe specimen development, activity or signaling for example.

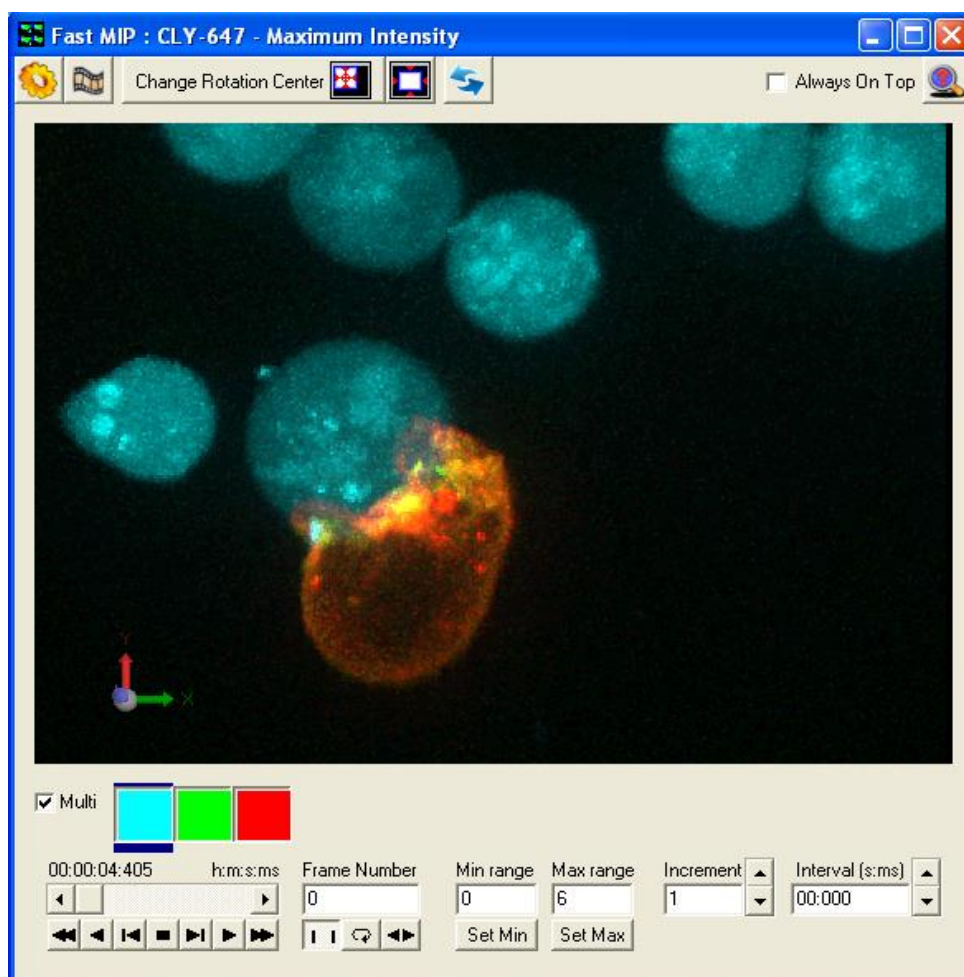

FastMIP can work with data volumes that have Z or Time as the 3rd axis. In the

latter case this can be helpful for viewing timed events in a 3D Kymograph , but restricted to orthogonal slicing. With Z as the third dimension we see an extended focus image of our living or fixed specimen as shown above.

When you view a volume at large angles you will see gaps between Z sections in the data because we load only the head-on view for faster performance. If you want good rendering at all angles then use the 4DView from the View menu which is essentially identical, except it used XY, XZ and Y-Z views of the data for better rendering at the cost of speed. The dialogs and controls behave in a similar manner.

5.11.1 FastMIP and 4D View Options and Animation settings

FastMIP and 4DView have options for visualization, cropping, movie/animation creation and image update when XY dimension is changed in the Image Window. Zoom is coupled to the mouse wheel, while holding down the mouse left button and dragging the cursor left-right and up-down will change the angle of view on the data set. The tools to control FastMIP are explained in a message box when you click on the magnifying glass with query (?) at the top right of the dialog.

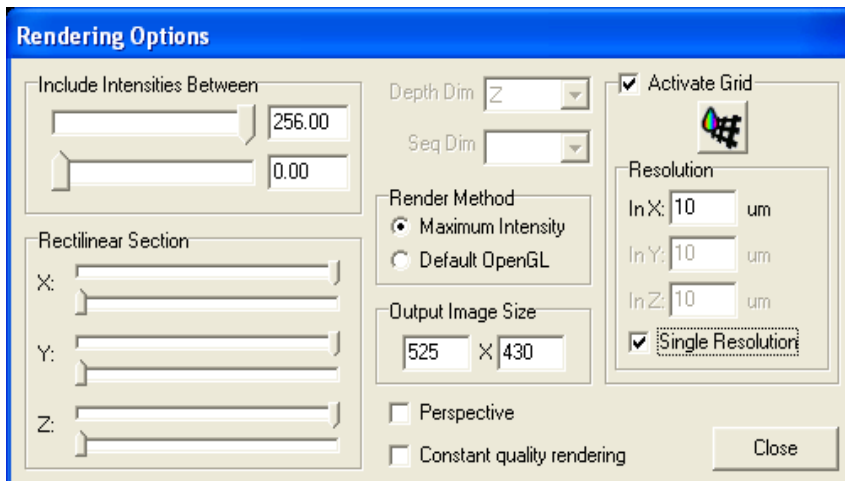

The dialog left shows Rendering options – access by click on the Gear button. Here you specify grey levels to render, crop in X,Y, Z, specify render mode, switch perspective and a calibrated grid in the rendered image.

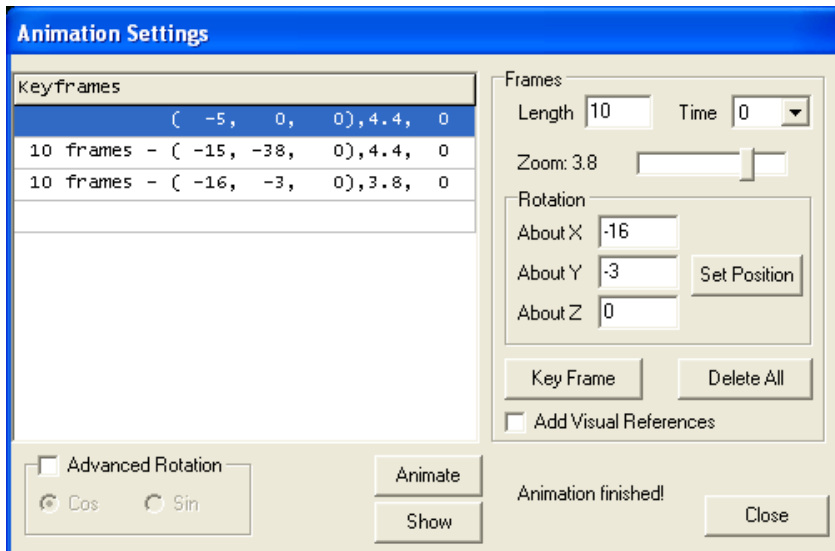

In Animation settings the animation is specified by a series of Key frames which record Visualization state when you click in the Key Frame button. You can set these parameters to exact values using the Rotation, Zoom, Length

and Time settings or you can interactively adjust for “nice” views and record those. When you click on Animate the renderer settings are interpolated from one Key frame to the next and the interpolation rate is set by the Frame Length setting, which can be varied between Key frames for maximum flexibility.

5.11.2 Note on Graphics card and drivers

Note: Depending on Graphics card and drivers you may get some interaction between the OpenGL code and DirectX code which is used for the Main Image Window. Examples of problems we have encountered are flashing or incorrect update of the DirectX window during OpenGL operation and/or pollution of the animation with overlapping dialogs remaining in the rendered result. Because of these possibilities we recommend you visit your graphics card website and download the latest drivers wherever possible. More recent systems supplied and tested at Andor do not exhibit these problems.

5.12 Montage View

The Montage tool is companion to Montage scanning explained in some detail in Chapter 4. The Montage tool is designed to stitch together a series of frames from overlapping fields, reconstructing them into a larger field of view image.

In order for Montage to complete this task iQ stores in the image **meta-data** (see Appendix) the position coordinates of each field of the Montage. Montage uses this information to adjust the overlap between frames and then merge them into a result. See examples below.

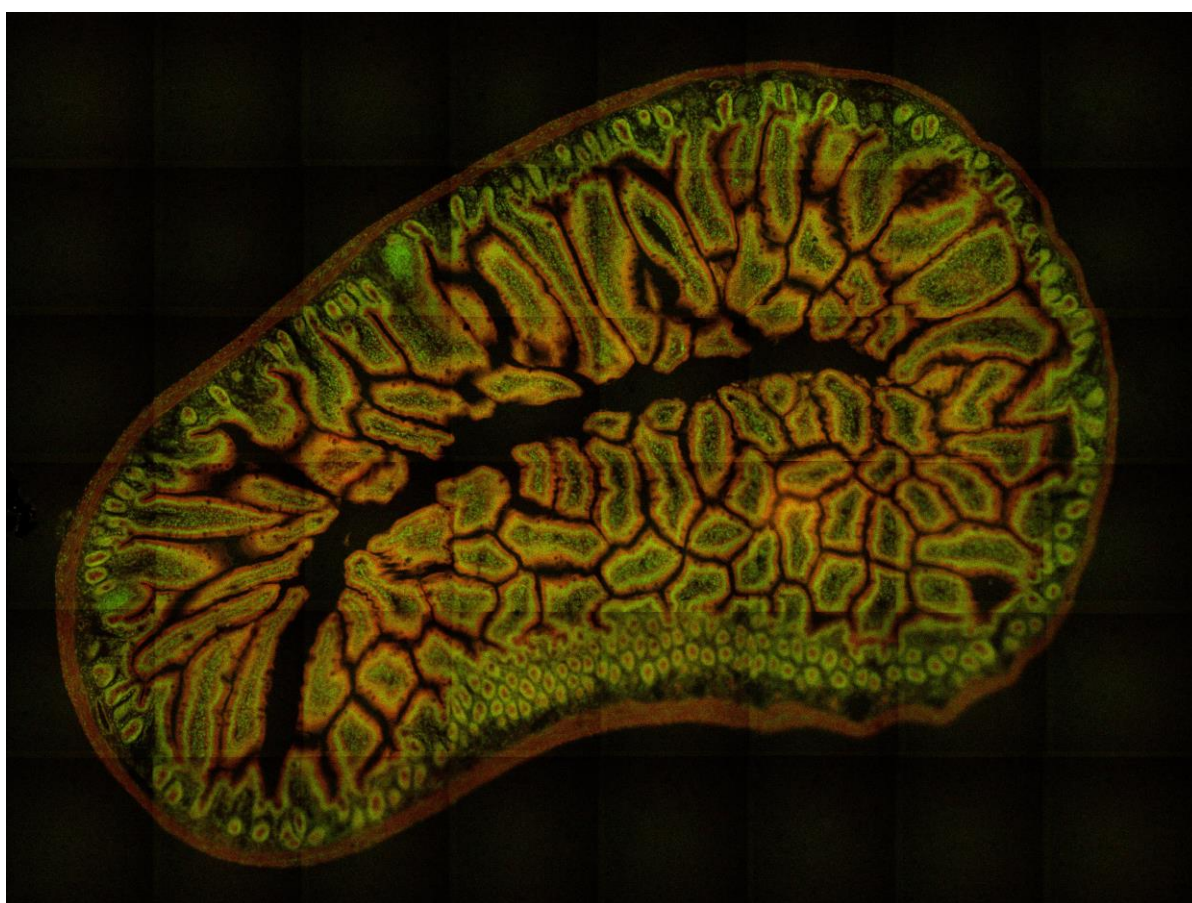

The image above shows a Montage of 48 (8x6) fields @ 20 X magnification from a Molecular Probes slide of a mouse gut section. Tiling artifacts are visible.

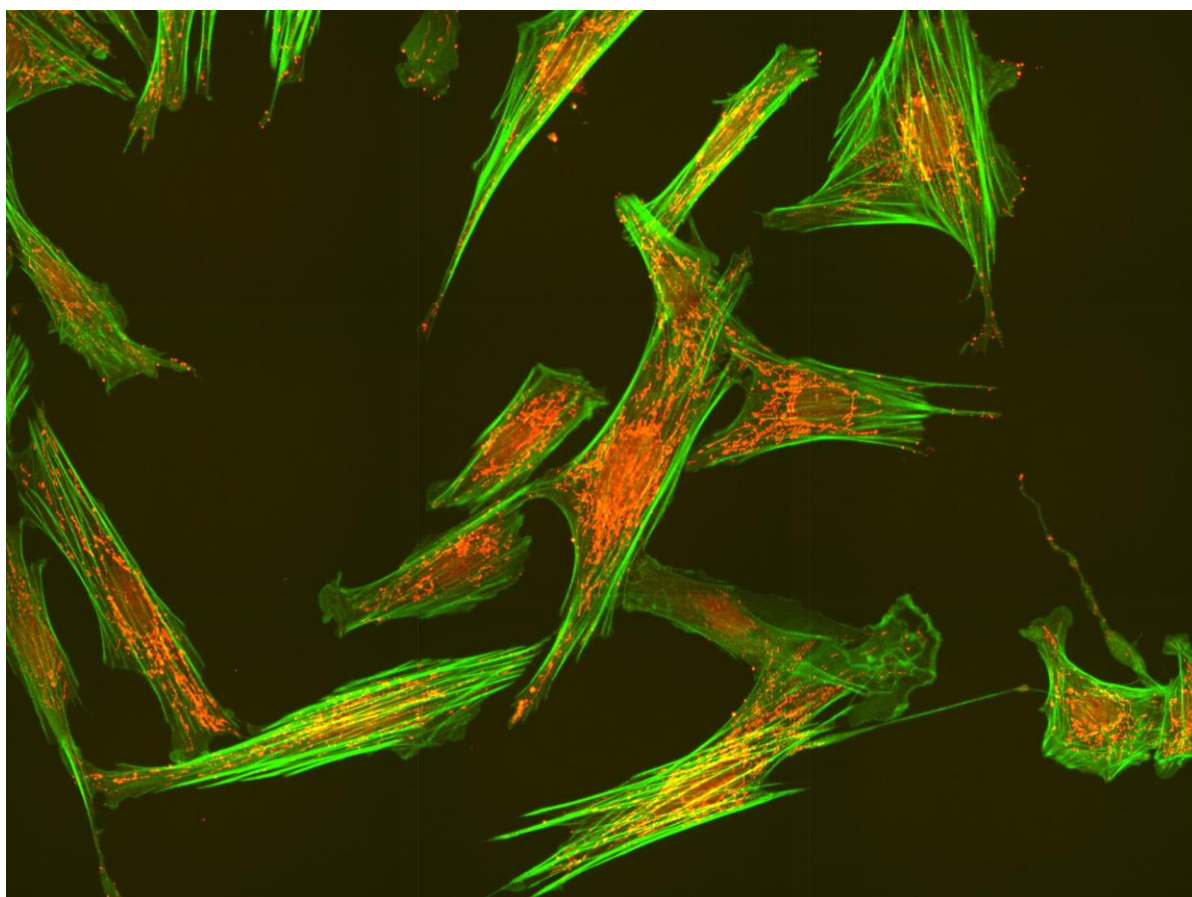

This image shows a Montage of 24 (6x4) fields (60X oil 1.4 NA objective) using the Revolution XD laser confocal system. The field images comprise 30 Z planes and 2 channels each and were stitched with Montage and a maximum intensity projection (MIP) produced to show this result.

5.12.1 Montage View and Dimensions

The Montage View tool requires that the image has a Montage dimension. iQ produces this dimension when it performs a Montage scan or a Multi-field or Multi-well scan with Montage enabled. Such an image is shown in the iQ Image window below. Note that the image also contains Time, XY (also known as Field), Z and wavelength dimensions.

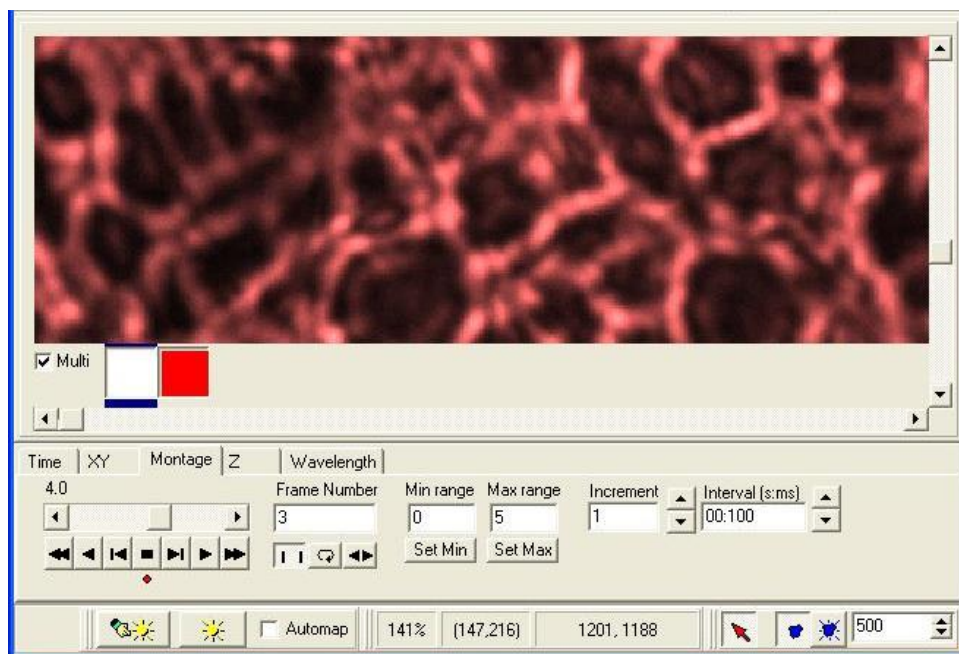

To produce a Montage from the image above, we simply select the View menu and then click on Montage and the Montage dialog will show. The figure below shows this and the Options dialog has been overlaid for convenience.

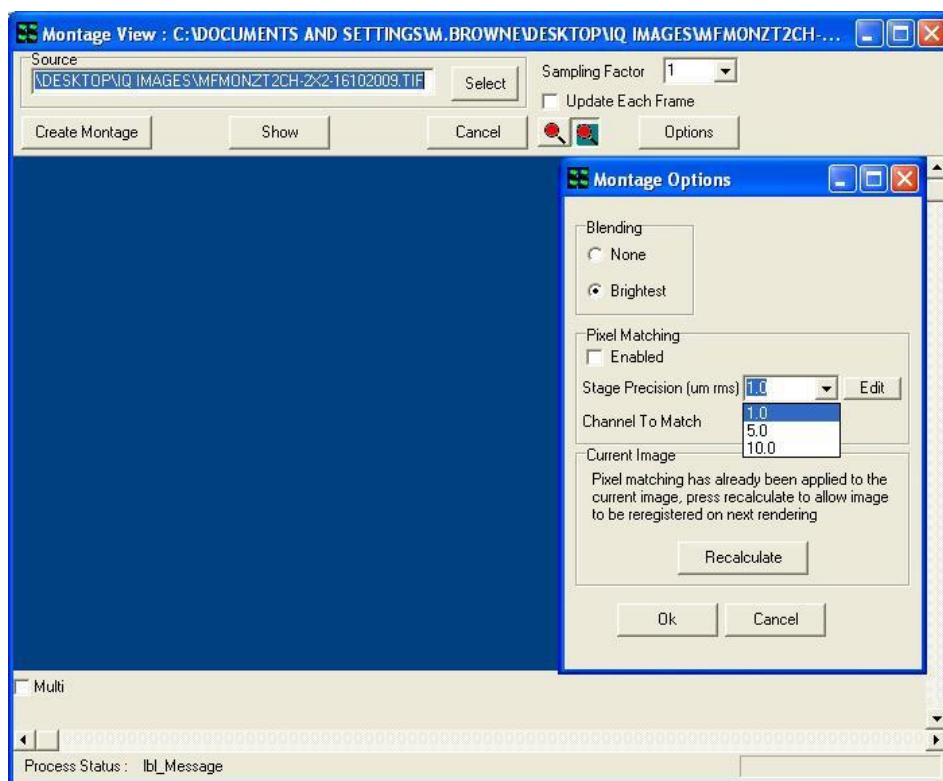

5.12.2 Montage View Options

The Options dialog allows you to choose how image edges are **merged**. **Brightest** is best for fluorescence images.

If **Pixel Matching** is checked then iQ attempts to match image edges by correlation matching regions to find a best fit. Based on the best correlation iQ will stitch images with the correlation peak offset in X and Y. You can decide how large a range iQ should search over to match pixels and in the drop down box, where you can select 1, 5 and 10 um by default, but you can add further values depending on your specific configuration and results. You can also specify which channel is used for matching.

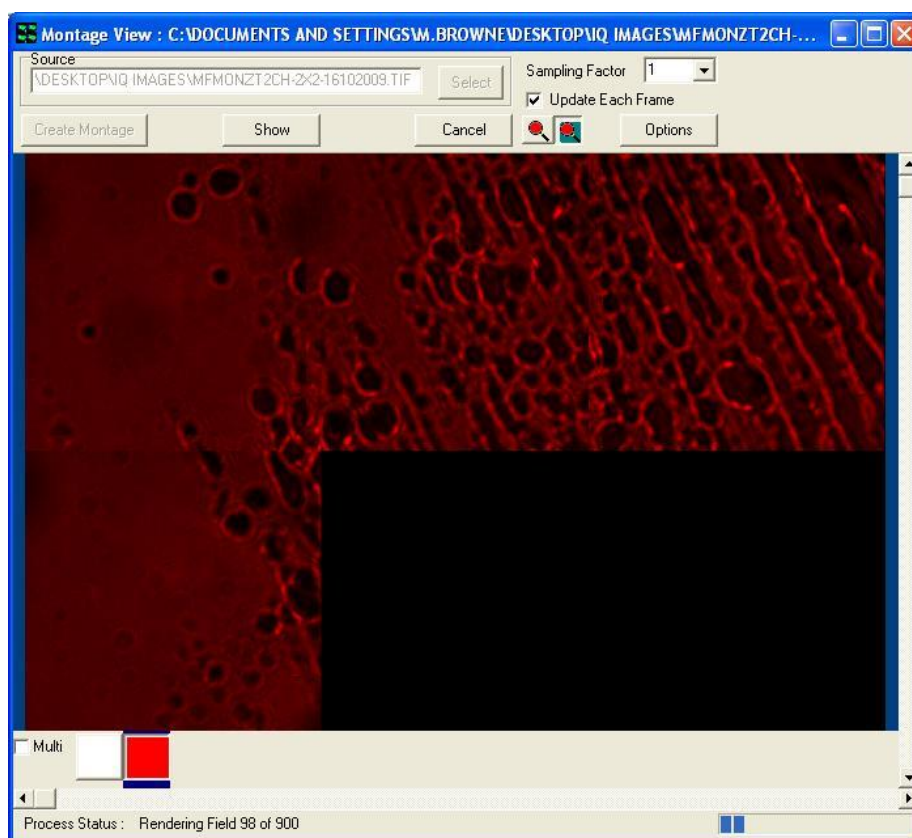

To produce the montage result in the shortest time leave **Pixel Matching unchecked**. In this case edge matching will be limited by stage precision. So the choice depends on your needs.

If you check **Update Each Frame** the image will be redrawn for each frame tiling

operation as shown above. This will slow down reconstruction, but it provides useful feedback. The Montage dialog above shows the result being updated part way through a reconstruction. Note the progress information on the bottom Status bar which provides a processed frame number count and a total frame number count in the dataset.

Before iQ starts the reconstruction, it allocates a destination or result image on the ImageDisk. To do this it estimates how large the result will be by looking at the meta-data and computing the result X and Y dimensions from the field data and scan settings. If the X or Y dimensions exceed 4096 pixels, then iQ will **subsample** the image to ensure it fits within this range. The reason for this is that Windows® has trouble rendering images that exceed 4096 pixels in X or Y and performance is greatly reduced. So we took this decision for performance reasons.

You can choose the **sub-sample** option before reconstruction if you want to control the result. When the image reconstruction is finished you can click on **Show** to send the image to the iQ Image Window, where we will now see (below) the Montage dimension is no longer available, but the reconstructed image retains all other dimensions.

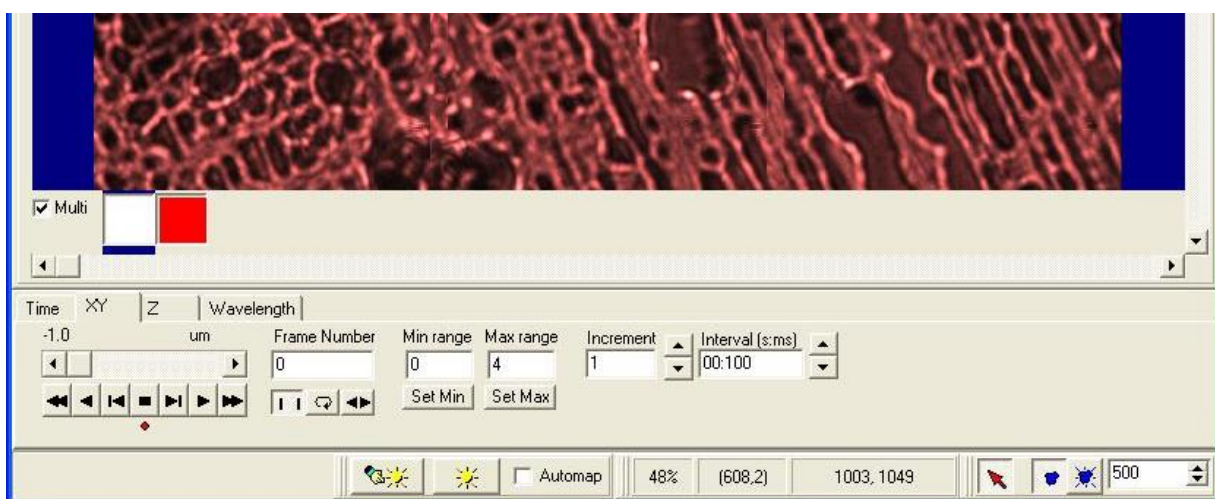

5.13 FRAP Analysis

The FRAP analysis has been provided to allow extraction of quantitative values from FRAP experiments using semi- quantitative curve fitting methods. It provides an optional normalization correction method (either from the pre-bleach or from a separate reference region). Results are calculated either from the original or corrected data fits, depending on what correction mode the user has chosen. The user can select combinations of points in the multidimensional image acquisition and define any number of FRAP periods within each region.

5.13.1 Terminology

It is useful, before proceeding, to explain the following terminology:

Point Position: A point in the image dimensions from which a time series can be plotted.

Region: Used in two contexts:

- An ROI set on the image view
- A curve displayed in the analysis dialogue.

There are two types of regions:

- FRAP Region. Within which the FRAP occurs.
- Reference Region. An optional region which provides data for correction.

FRAP Period: A FRAP Region can contain any number of FRAP Periods. The duration of an entire FRAP event.

FRAP Interval: A FRAP Period always consists of four FRAP Intervals. The time period over which a characteristic FRAP sub event occurs. There are four different intervals:

- Pre-bleach.
- Bleaching.
- Recovery.
- Steady State

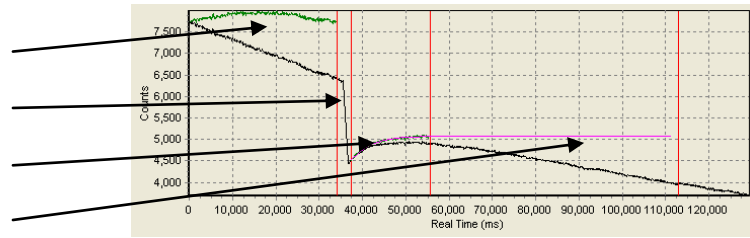

5.13.2 The FRAP Analysis Dialogue

The FRAP Analysis dialogue is opened from the Analysis menu in the main iQ window. It is dynamically populated depending on the user experiment. An example is shown below.

An experiment was carried out with an initial loop of 10 snaps in order to establish a pre-bleach. It then obtained 50 Z-stacks in the post-bleach. A FRAP region and two reference regions were defined on the image overlay. [The tool also allows the option of overriding any historical region data on images loaded from the image disk. Remove any historical regions and create new ones in the desired locations].

The dialogue for this experiment appears as below:

- [-] Protocol - Protocol1
 - [-] Image - Protocol1
 - Camera Binning - Use Current
 - Wait Allocation - Off
 - Camera Selection - Use Current
 - Events
 - Repeat T - 100 times (0 ms - fastest)
 - Snap - Frame
 - End - T
 - Frappa - frap (Mosaic, Selected, _FRAPPA)
 - Repeat T - 1100 times (0 ms - fastest)
 - Move Scan Z (26)
 - Repeat Z - 38 um in 20 planes
 - Snap - Frame
 - End - Z
 - End - T

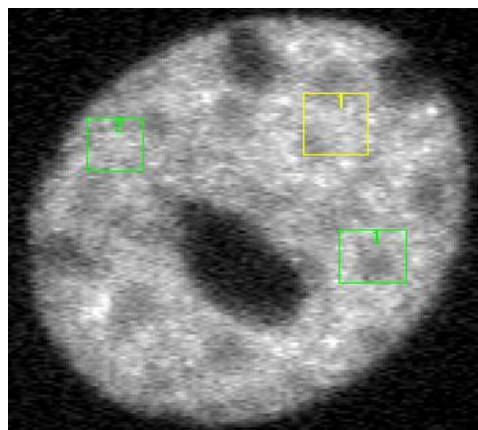

-Florian Müller, National Institute of Health, Fluorescence Imaging Group

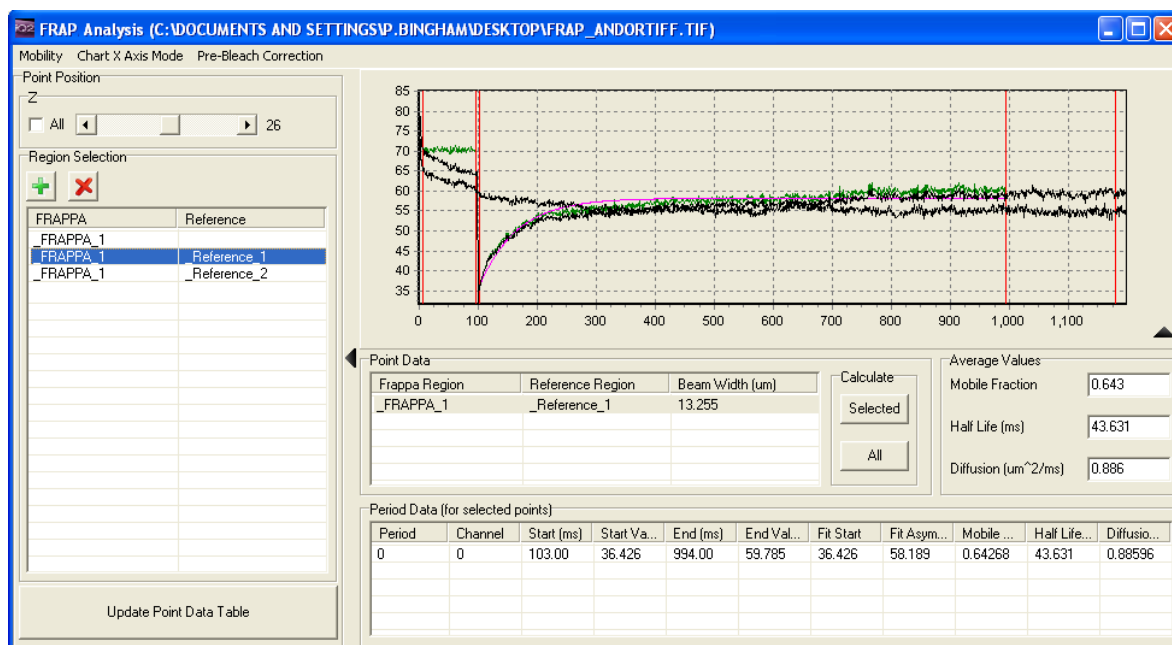

Note the following:

- Each selected position in the Z dimension corresponds to one region consisting of the 100 pre-bleach frames and 1100 post-bleach frames.
- The curves:
 - Black: Real data. In this case the FRAP and reference data.
 - Green: Corrected data.
 - Pink: Fitted curves.

5.13.3 Region Setup

A region is defined by its Point Position, its ROI and whether it's FRAP data or correction data.

To add a region:

1. Choose the point position.
2. Click the add button.
3. The following dialogue will appear. Choose the click Add.

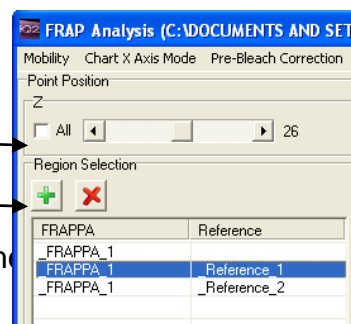

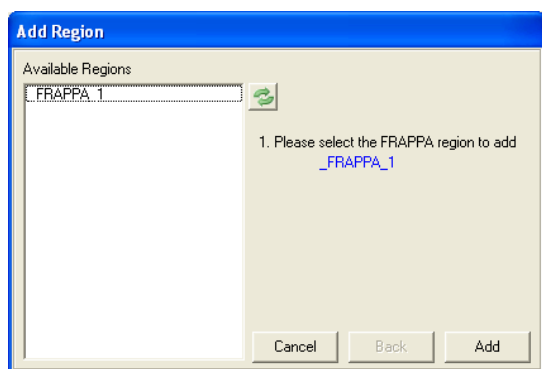

4. The next step will list the reference regions. Either add one or choose None, as required.

The setup process will depend on what correction is being applied. The user may choose one of the following correction methods:

No correction: Selected by not choosing a reference region and disabling correction from the Pre-bleach Correction menu.

Pre-bleach correction: As above but enable the correction from the menu.

Reference region correction: Select an ROI in step 4 above and enable the correction from the menu.

To view the added region, select the created region and click Update Point Data Table.

5.13.4 Defining and Modifying FRAP Periods and Intervals

In order to carry out the calculations the user needs to define where the four FRAP intervals occur.

- If the user selected All in any of the Point Position checkboxes then there will be several rows populated in the Point Data table. Choose the one that is of interest. The chosen curve will become highlighted in the chart.
- Right-click on the chart and select Insert Period.
- Move each of the five red lines so that the four intervals are properly defined. The first four lines define the point at which an interval *starts*. This is illustrated below. The ellipses contain the points included in each of the distinct intervals.



The end of the Steady State interval sets the extrapolation extent, i.e. the curve is fitted to the data in the recovery region and this curve is then extrapolated out to the end of the Steady State interval. The calculated values are derived from the extrapolated curve. Note that the extrapolated curve is only visible when plotting in real time.

If a boundary is set between two points, it will be moved to the nearest point.

- If other Periods require setup then either:
 - Add another Period to the currently selected Point Position.
 - Select another Point Position in the Point Data table and add the Period to the highlighted chart.
- Click Selected to perform the calculations for the selected Point Positions
- Click All to perform the calculations for all of the Point Positions in the Point Data table.
- Once calculations have been made for any periods, selecting them in the Point Data Table automatically populates the Period Data Table.

5.13.5 Additional Analysis Options & Features

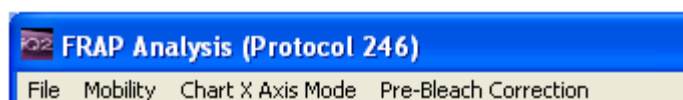

From the menu, the user may also:

- Zoom in and out on the graph by clicking and dragging along the X axis with the middle mouse button. Click and drag right to zoom in, click and drag left to zoom out.
- Change the mobility calculation to either pure flow or pure diffusion.
- Change the x-axis type. The user can plot either from the point index or real time. Note that any extrapolations are only shown when plotting in real time.
- Save data to file.

5.13.6 Calculation Details

The pre-bleach or reference region fit takes the form: Ae^{-Bt}

The recovery fit takes the form: $A(1 - e^{-Bt})$

The diffusion and flow quantities are determined using the derived equations (19 & 20) in:

D. Axelrod, D. E. Koppel, J. Schlessinger, E. Elson, Andw. W. Webb, "Mobility Measurement by Analysis of Fluorescence Photobleaching Recovery Kinetics", Biophysical Journal Volume 16, 1055-1069 (1976)

Note that a fully quantitative calculation is not performed and that a circular beam profile is assumed.



6 - Processing Tools

6.1 Process – Episodic Average

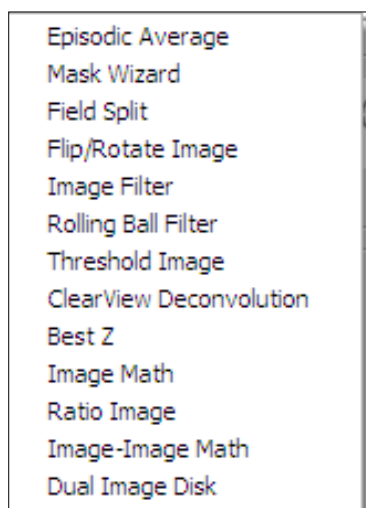

The Episodic Average plugin can be found in the Process menu in iQ's Main Window and is used to average multiple repeats of an "episode" or experiment to produce a resultant image which is the average of all episodes selected. The images must be identical in all dimensions (e.g. time, XY, bit depth, wavelengths etc.).

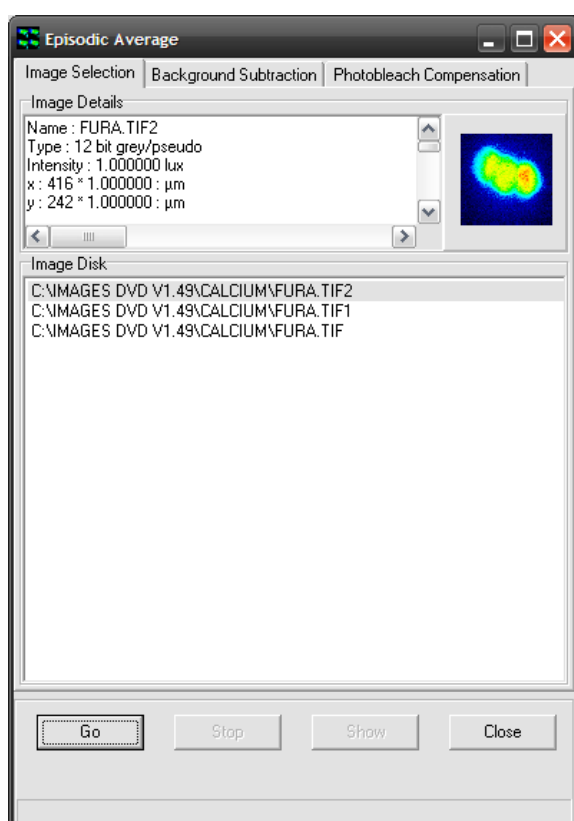

After opening the plugin, simply select two or more images from the Image Disk (using the standard Windows function of holding CTRL or SHIFT while using the left mouse button to select items). Once the images are selected, press the "Go" button to create a new image that will appear at the top of the ImageList with the extension "_ave" to show that this was created with the Episodic Averaging plugin. Selecting this image and clicking "Show" will load it into the Image Window.

Two additional operations can be performed, if desired: Background Subtraction and Photo-bleach Compensation.

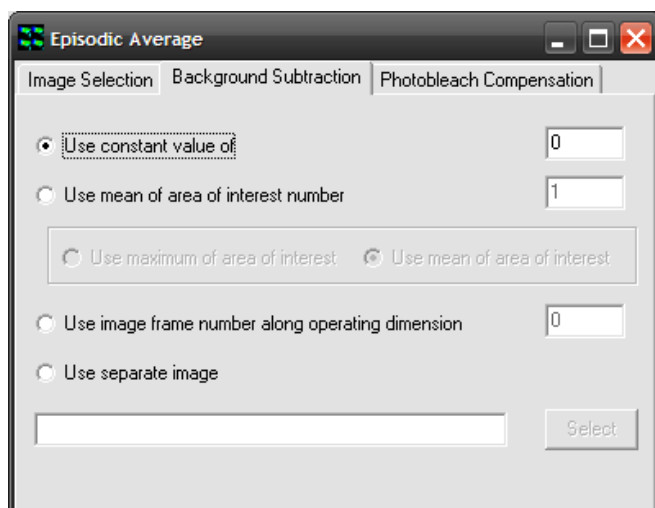

Switching to the Background Subtraction tab, shown above, there are four separate methods for correcting for background intensity in some way:

Subtracting a constant value – by selecting “Use constant value of” and entering a value in the text box

to the right, this value will be subtracted from each pixel in the resulting image.

Using a ROI – by selecting “Use mean of area of interest number”, drawing a ROI (region of interest) on the image and entering the number of this ROI in the text box, the mean of this region will be subtracted from each pixel in the resulting image. When this option is selected, an additional option appears below it, allowing either the mean of the maximum value in the ROI to be used.

Using an image from within the series – “Use image frame number along operating dimension” will subtract an actual image, as opposed to a single value. A value of zero corresponds to the first frame.

Using another image – “Use separate image” allows a different image from the images being operated on to be used for background subtraction. It must have the same dimensionality as the images being averaged. When this option is selected, the “Select” button is used to load the image from the ImageList, hence it is a good idea to load this image into iQ before running the Episodic Average plugin.

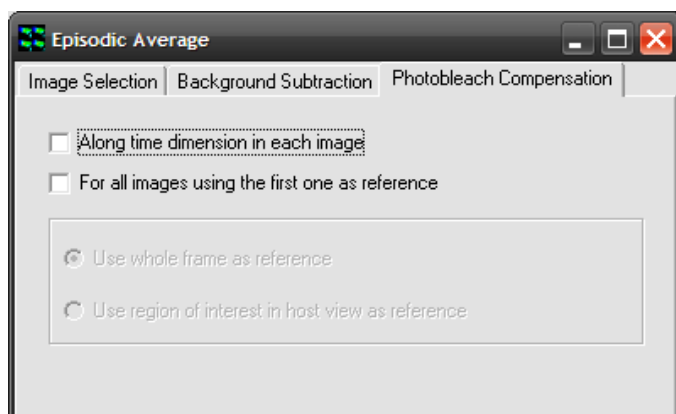

Switching to the Photo-bleach Compensation tab shows the dialog left. Selecting either checkbox will enable photo-bleach compensation in the resulting image.

Selecting “Along time dimension in each image” will normalize the intensity of the images through the series along the time dimension. When this option is checked, the greyed-out section below it becomes available, allowing the choice of whole image normalization or normalization using the currently selected ROI in the Image Window.

Selecting “For all images using the first one as reference” will attempt to normalize all images in all dimensions using the first frame in the series as reference. When this option is checked, the greyed-out section below it becomes available, allowing the choice of whole image normalization or normalization using the currently selected ROI in the Image Window.

6.2 Mask Wizard

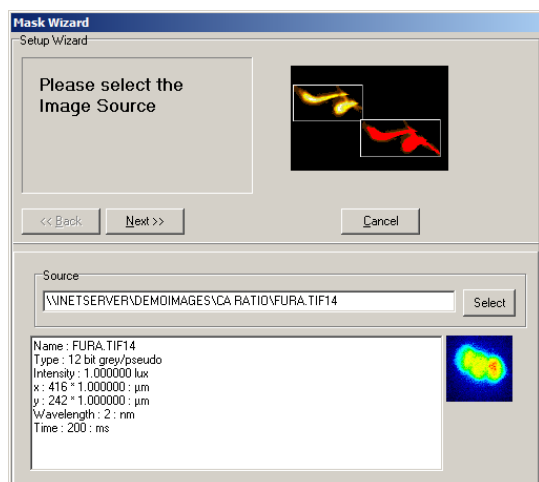

In image analysis it is common practice to isolate features of interest for subsequent measurement. This tool enables a binary mask to be created, which can be applied to any image using standard mathematical operators, prior to image quantification.

The **Mask Wizard** is accessed from the **Process** menu on the control window.

Clicking on the selected item launches the set up wizard shown below.

Following the execution of a pre-processing algorithm, a user-defined threshold is applied to the source image to create a binary mask.

The functionality of this module is identical to that discussed in the section describing the use of the Ratio Tool. Further details concerning the use of the Mask Tool can be found in **Section 6.11**.

6.3 Field Split

The Field Split tool is intended for use with optical devices which split the image field into two or more regions, according to wavelength separation of the emission light from the microscope. The splitting technique allows simultaneous multi-wavelength emission imaging and is useful for FRET (e.g. CFP-YFP or GFP-RFP), ion imaging (e.g. Indo 1), co-localization and other multi-channel dynamic imaging. The technique avoids any delay between image channels, and is therefore most applicable to live specimens, but can be used with fixed samples.

Optical devices of this kind provide a selection of wavelength by insertion of user-defined filters or polarizers. One class of devices is designed for single detector use, such as the Optical Insights DualView, Cairn Research OptoSplit and Hamamatsu Photonics W-View. Each offers various benefits and options. Another class of splitters is designed for use with two detectors, such as the Andor TuCam.

Because splitters are purely optical devices they are not under iQ control, and are placed in the optical path between the microscope top or side port and the camera. The image split usually occurs in the X axis and consequently, the resulting image resolution is half that of the camera resolution in X, with full resolution maintained in the Y direction. The Quad split device produces four images each with half resolution in X and Y.

A Field splitter optical device splits the image by wavelength and the channel images appear side by side on the camera as shown below.

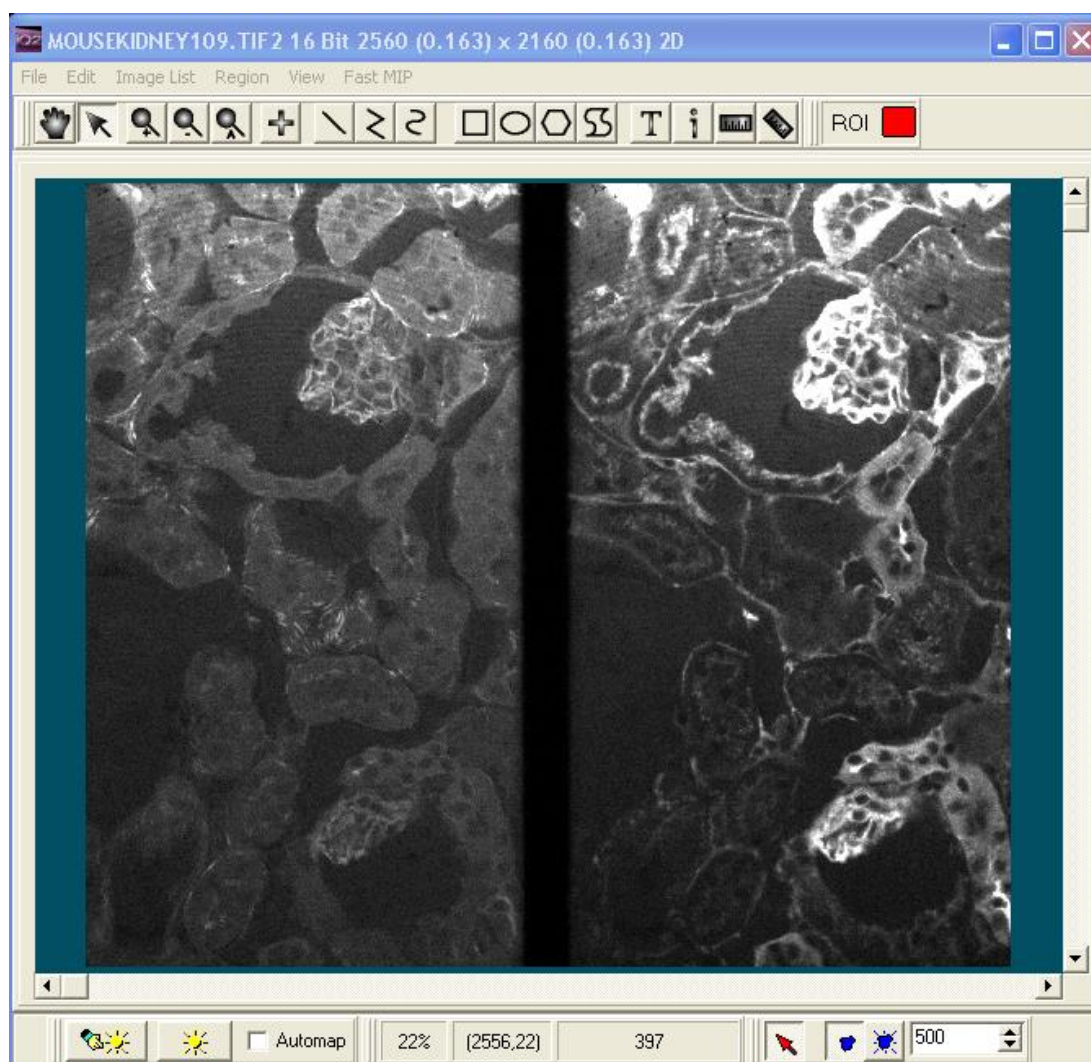

The image projected onto the camera, and therefore seen during acquisition, shows the two channels (or wavelengths) images side by side as shown above. Lateral alignment of the images after capture can be performed by Field Split tool, but it is important to follow the manufacturer's advice on setting up and aligning the device with the CCD camera first. Some suggestions on doing this in iQ are provided in

Section 6.3.3.

The Field Split tool is accessed from the Process Menu on the Control Window. The Field Split tool is used to separate the side by side channel images into two, three, or four channels by selecting, sizing and aligning that many regions of interest (ROI). The data underlying these ROIs are used to create an image for multi-channel viewing and analysis, with one channel per region of interest.

Field Split works on 8, 12, 16 bit grey and 32 bit float images, but not with RGB color

images. The Image Registration feature works with 12 bit and 16 bit grey images only. At present, Field Split only works on images on the Image Disk.

6.3.1 Steps for Setting up the Field Split Process

Open a suitable image from the Image List. Once image is loaded, select Field Split from the Process menu options.

Note: If your source image is a Z stack, you **should** select a well-focused Z point in the Image window before starting the Field Split Process, as this will make the alignment process easier.

The Image Window displays two rectangular ROIs in the window: one in blue labeled “r1”, the other yellow labeled “r2”, as shown below.

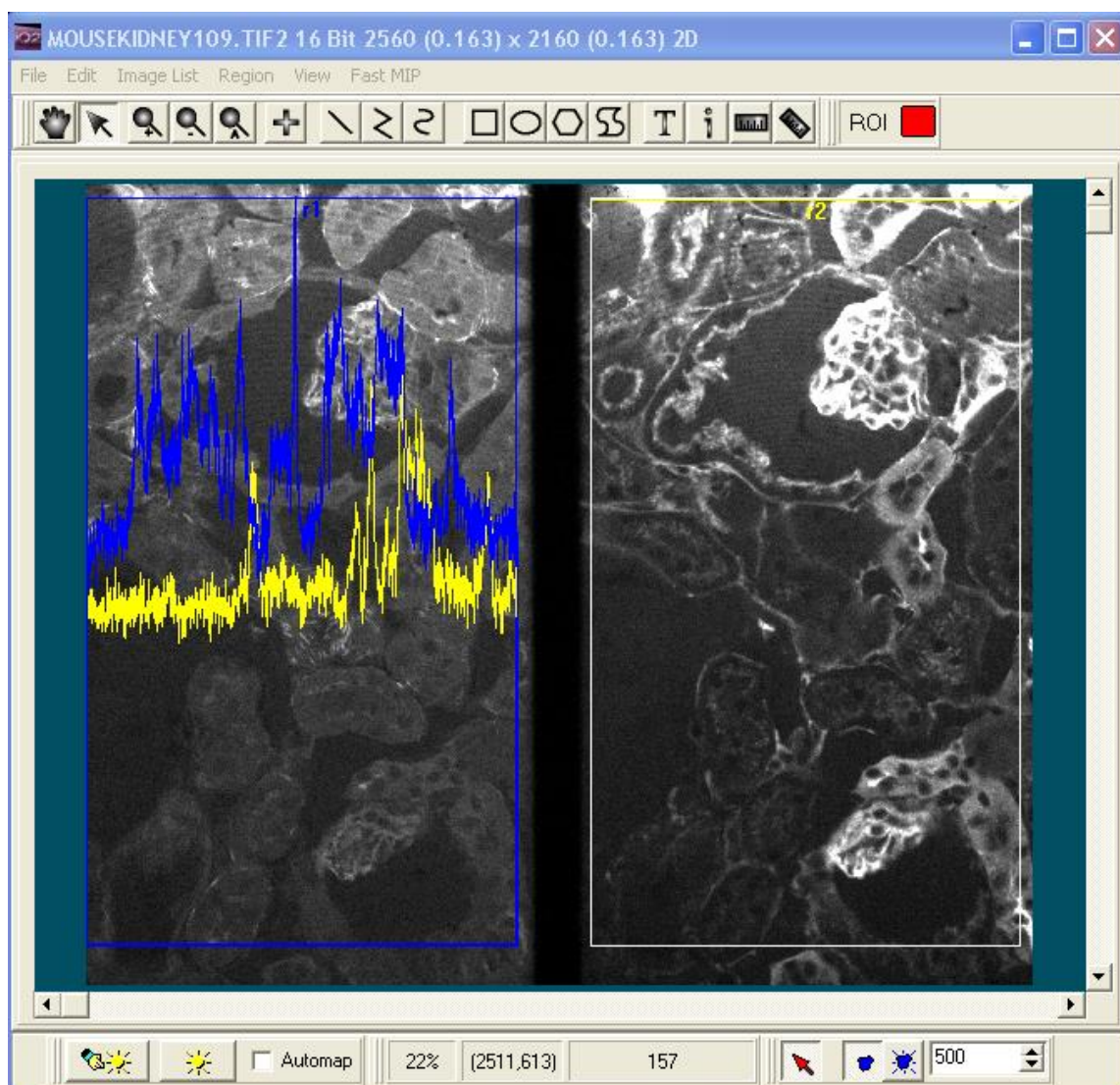

Andor iQ USER GUIDE

The Image Window shows the two channel ROIs in Yellow and Blue. By enabling Profile options (found on the field split window) the Line profile option overlays the right and left channel data, to allow alignment on a feature which is visible in both channels.

During this process, the Field Split Window will open and display a new multi-channel image, which is formed by treating each ROI as a separate channel, as shown in the below screenshot.

Note: You will need to use a calibrated multi-fluor bead specimen (or your judgment) to confirm if the new dual channel image is adequately aligned. You should observe the change on the Field Split Window while adjusting the alignment (position, size, shape) of the two rectangle ROIs in the Image Window.

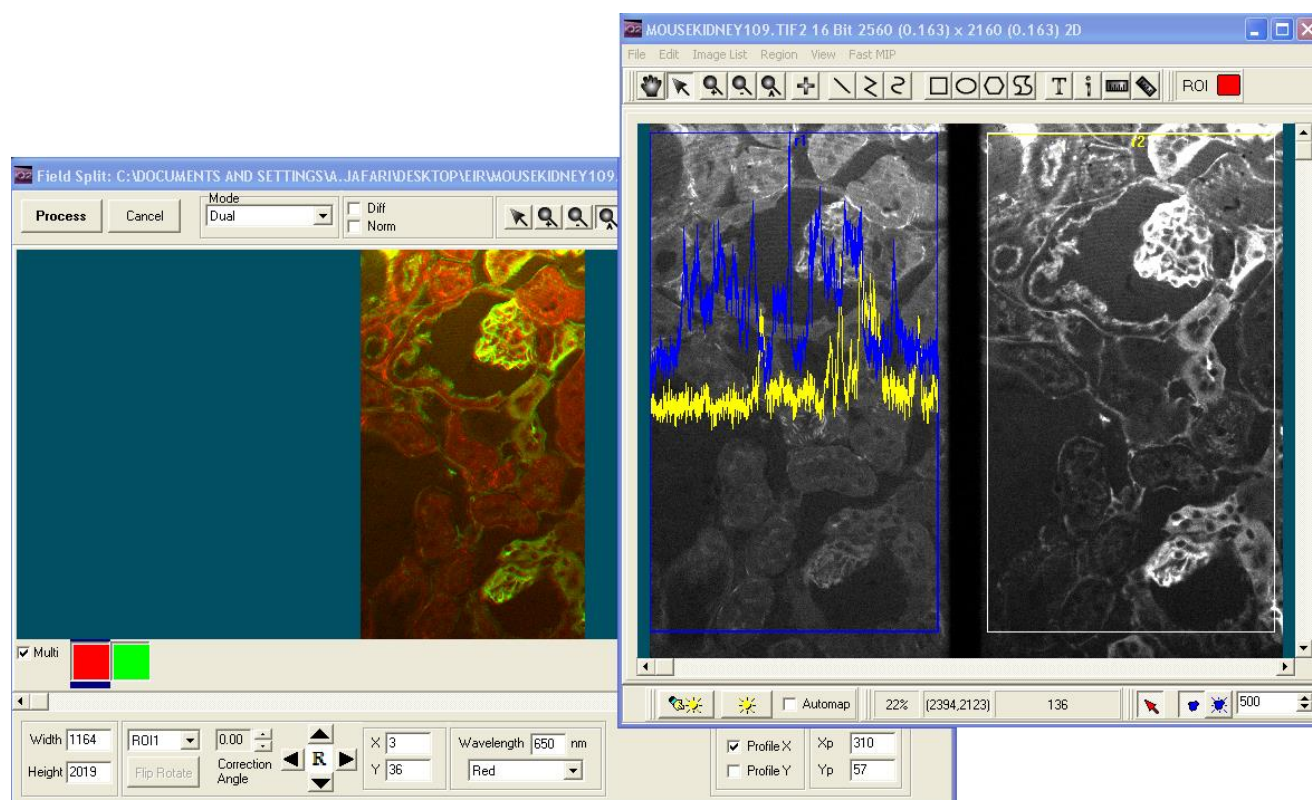

While you adjust the ROIs on the Main Image Window, the Field Split Window shows the multi-channel merged view. This is a guide to aid vertical and horizontal alignment. For fine alignment you can use the Profile options which show the intensity profile in X and/or Y across the selected points in the selected regions.

The Image Window can be moved aside to see the new multi-channel image in the Field Split Window. Select the Multi option to show all channels or select the

coordinating box to show each individual channel.

6.3.2 Field Split Window Toolbars and Options

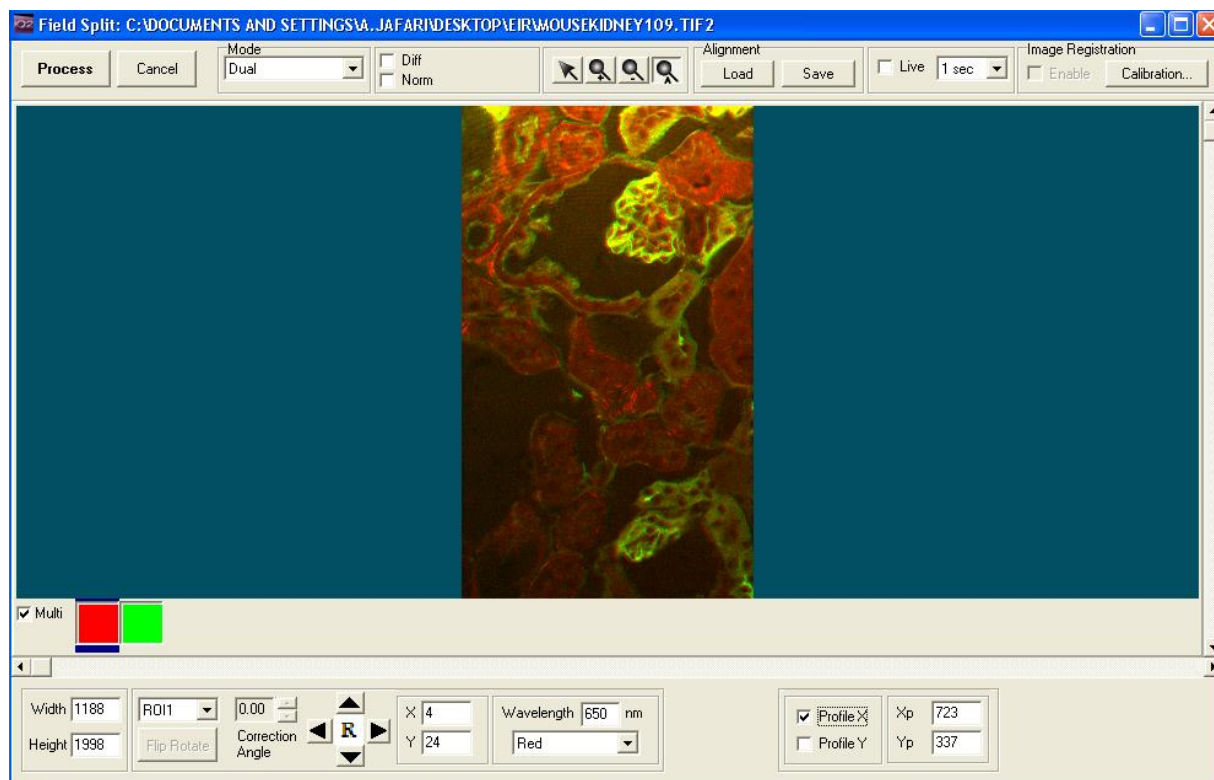

The above screenshot shows the preview image. Once you are happy with the two ROIs, and the preview multi-channel image, then click the **Process** button on the top-left of the Field Split Window. This will generate a new image on the Image Disk, display it in the Image Window, and close the Field Split Window. This may take a little time as the splitting process will be propagated throughout the other image dimensions, such as time, Z, and even multi-fields. A progress bar on the top of the dialog will show the stage of the processing

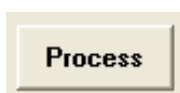

If you are happy with the two ROIs, and the preview multi-channel image, then click the **Process** button on the top-left of the Field Split Window. This will generate a new image on the Image Disk, display it in the Image Window, and close the Field Split Window. This may take a little time as the splitting process will be propagated throughout the other image dimensions, such as time, Z, and even multi-fields. A progress bar on the top of the dialog will show the stage of the processing

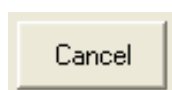

If you do not want to process the image, you can just close the Field Split Window at any time by clicking the **Cancel** button. During the processing, this button will instead abort the operation without closing the plug-in.

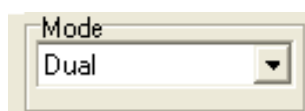

You can use the Mode drop-down box to specify how many regions of interest (ROIs) you want to use, from two up to four. The data underlying these ROIs are used to create an

image with the appropriate number of channels, for multi-channel viewing and analysis.

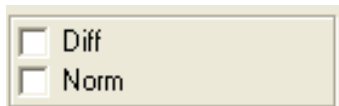

Enabling the Diff check box will update the Field Split Image Window with the subtraction of the two sub images.

The Norm check box is only available if Diff is already checked: this stretches the resultant image from Diff to get a better contrast.



The **Zoom** option enables you to zoom in, zoom out, and auto zoom the image displayed in the Field Split Window, enabling you to view the fine detail of features of interest more clearly.

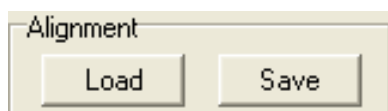

Before closing the Field Split Window, you can save the alignment as an alignment file by clicking the **Save** button on top of the Field Split Window. You can also

load alignment files into the Field Split Window by clicking the **Load** button at any point of the selection process.

By checking the **Live** check box, the Field Split Window starts sampling from the

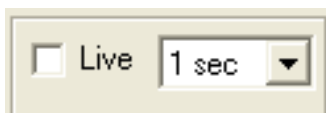

Main Image Window and refreshes the image at the selected rate.

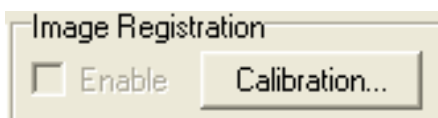

Use the calibration button to create a new Image Registration calibration, or to load an existing calibration. Once a calibration is acquired, it will be

applied by default: you can use the checkbox to disable Image Registration. See section A5.23 for the Image Registration How-To guide. The Image Registration feature works with 12 bit and 16 bit grey images only.

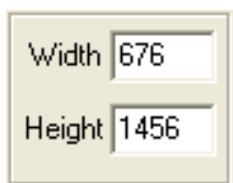

You can change the width or the height of the ROIs by typing new values into the Edit Box at the bottom of the Field Split Window. Press the [RETURN] key to express changes.

You can select each ROI through the

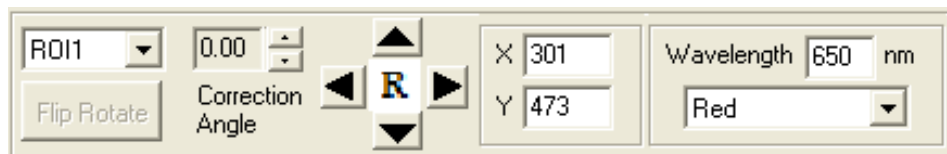

drop-down menu on the bottom of the Field Split window. The Flip Rotate button

rotates the selected region by 90° clockwise each time it is pressed. After a full revolution (four presses) it flips the image left-to-right, and further presses rotate the flipped image by 90°. After another full revolution (eight presses total) it returns to the original orientation. The Correction Angle spin control can be used to apply a small arbitrary rotation, in degrees, to the selected region.

You can click the Up, Down, Left, and Right buttons to move the selected ROI one pixel in that direction. You can also move the position of the selected ROI by typing new x, y values for the top-left corner of the ROI into the Edit Boxes named “X”, “Y”, then press the [RETURN] key to express changes. Each ROI has already been assigned a wavelength and a LUT; these are listed for the selected ROI at the bottom of the Field Split Window. You can change the wavelength values or assign new LUTs to them as necessary. The wavelength and LUT are applied at the end of processing.



You can have an x or y profile displayed across the ROIs by checking the check boxes named “Profile X” and “Profile Y” to help you judge the result of the alignment. For two ROIs, the profiles displayed have blue and yellow colors for ROI1 and ROI2 to distinguish between the two ROIs. The profiles are from a point marked by a small blue or yellow crosshair within the ROI.



You can move the point by using the mouse to drag and drop, or by typing new values into the Edit Boxes named “Xp” and “Yp” at the bottom of the Field Split Window.

6.3.3 Tips on Setup for a Field Splitter with a CCD Camera Using iQ

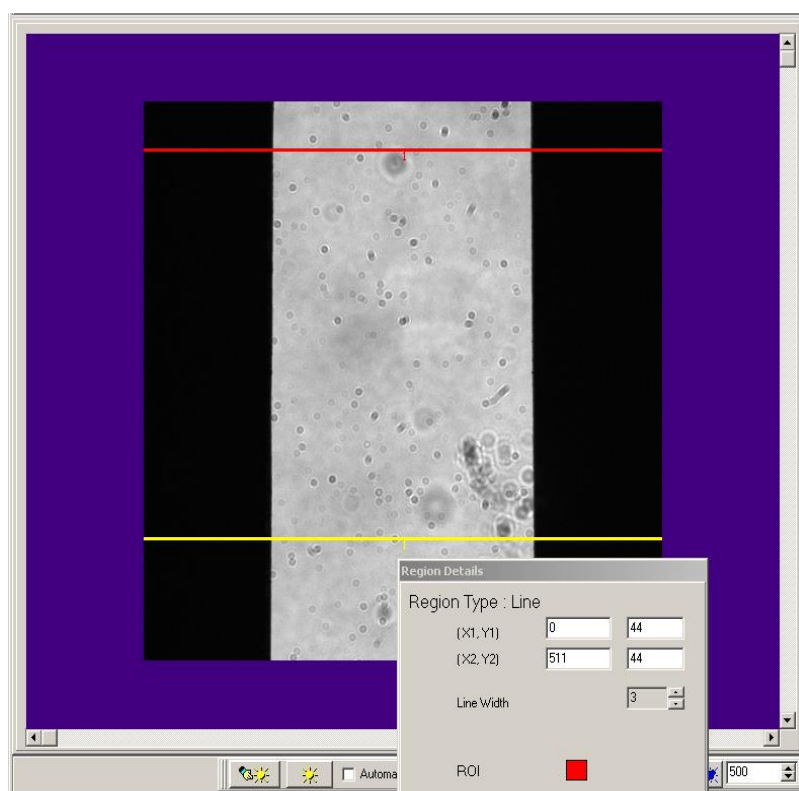

Refer to the manufacturer's literature for specifics. In this example we use the DualView as our example. Attach DualView to iXon or other CCD camera. Go Live and refer to the 5-Step Alignment procedure described by Optical Insights.

Step 2 – Orientation

To help establish the alignment of the Field Splitter with the CCD imager, you can use the Analysis/Line Profile in iQ. Draw two lines in the horizontal direction spanning the width of the image. Use the Right mouse Edit menu to adjust the individual Line details and ensure that they are aligned and span the image. Make sure the X1=0 and X2=511 or whatever the maximum size of the sensor and note that the Y1 and Y2 values will be identical for a horizontal line. In our example, the Lines are 512 pixels long and cross the edges horizontally. If the aperture edge is oriented orthogonal to the CCD chip then the two line profiles should show coincident transition from black (no light) to grey (light) at the edges, provided they have the same X1, X2 coordinates.

This picture shows the aperture image Live on the iXon camera, ready for adjustment of orientation. Microscope optics and slide debris apparent!

Select the Analysis menu Line Profile to show the edge transition in the vertically separated, but horizontally similar lines - make sure the Live mode is used so the line profile updates with the Live image. The graph on the next page shows the typical profiles for the two horizontal lines. If the orientation between camera and DualView is perfect then the 2 pairs of lines should show almost identical black/grey transitions.

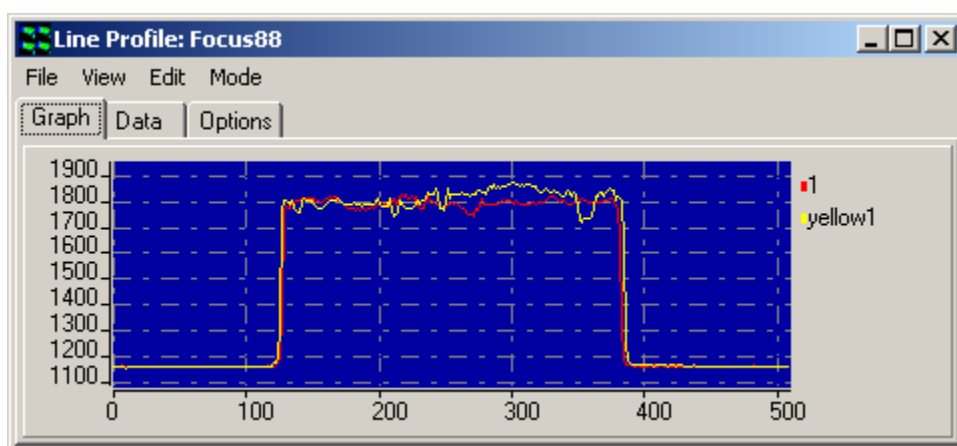

The above picture shows the Line Profiles (color matched to the lines) for ensuring correct orientation of the Camera and Field Splitter.

If the aperture of the Field Splitter is not parallel (quite common) then there will be a small shift between the edges in the two profiles and the width of the light area will be different at the different vertical positions as shown above for a real device.

Now you need to ensure that the transitions occur as stated in the DualView alignment procedure at 1/4 and 3/4 positions of the chip width. In the case of a 512x512 sensor as used in the iXon 887BV, then these should coincide with pixel number 127 and 383. You can check this with considerable accuracy using the Line Profile Zoom function, which is activated by dragging an ROI on the graphic around the edge of interest shown in our example below- see white rectangle. The graph will Zoom to show the ROI at higher resolution.

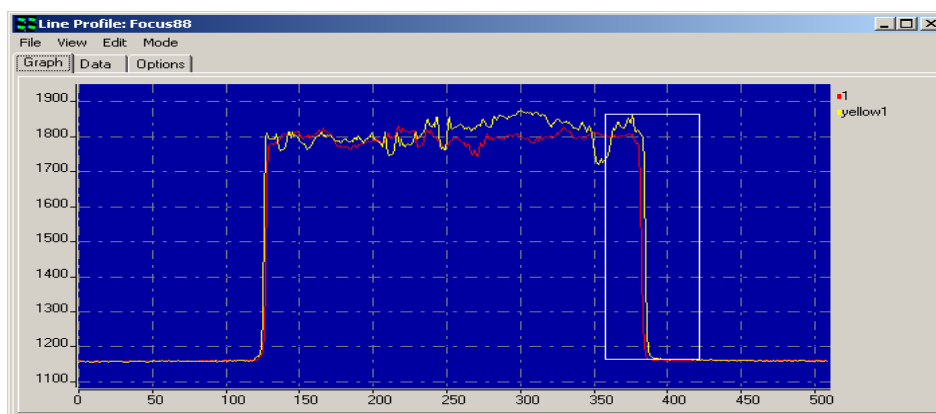

The above picture shows the means of Zooming on the Line Profile intensity edge for precise alignment of the edge position on the CCD chip.

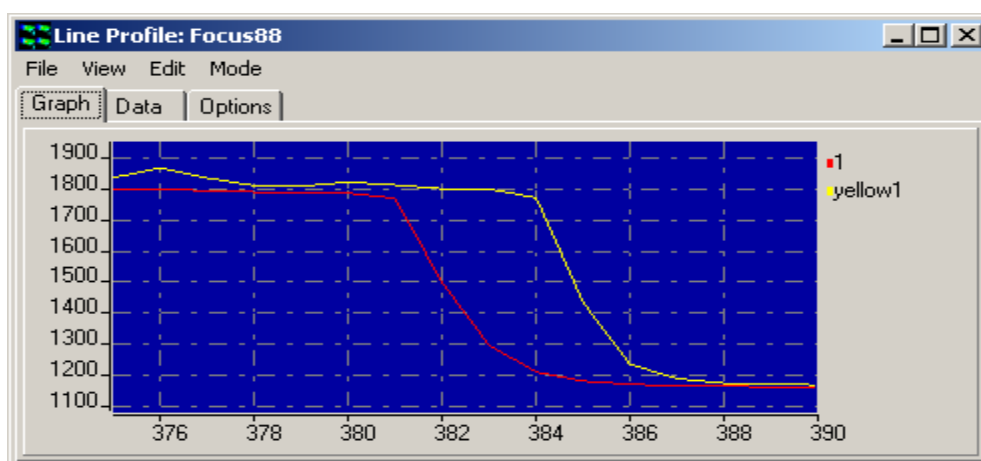

The above picture shows Zoomed intensity edges for precise alignment of the Field Splitter and the CCD.

Note: It probably will not be possible to get both lines to cross at exactly the same location, due to physical tolerances in the aperture of the Field Splitter, but the best compromise should be aimed at, taking into account both the $\frac{1}{4}$ and the $\frac{3}{4}$ crossing points. Post capture alignment in the Field Splitter tool will help to overcome these limitations, but there will always be a small residual misalignment, which should be evaluated as part of experimental error analysis.

Once these steps have been achieved the orientation, width and alignment are complete. Now it is time to start imaging!

6.4 Flip/Rotate

The **Flip/Rotate** Tool is accessed from the **Process** menu. Clicking on the selected item displays the dialogue shown below.

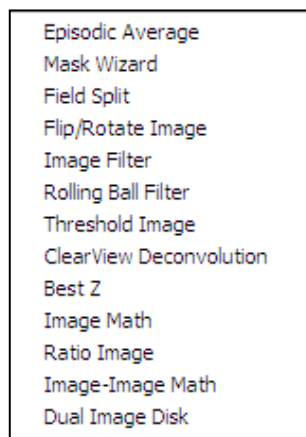
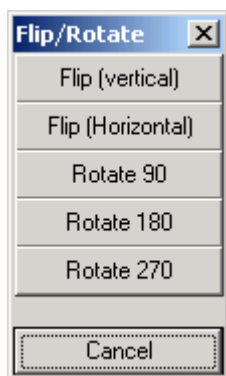

The **Flip/Rotate** function enables any image displayed in the Image Window to be reoriented to one of five different geometries by clicking on the appropriate button. Images can be flipped about the vertical or horizontal axes, or rotated through 90, 180 or 270° in the clockwise direction.

This tool is useful for correcting feature geometries prior to analysis or reorienting images for publication.

6.5 Image Filter

The Image Filter plugin can be found in the Process menu in iQ's Main Window and provides some common image filters, such as averaging and edge-detection. When opened, the Image Filter window will appear with a preview of the currently displayed image, as shown below.

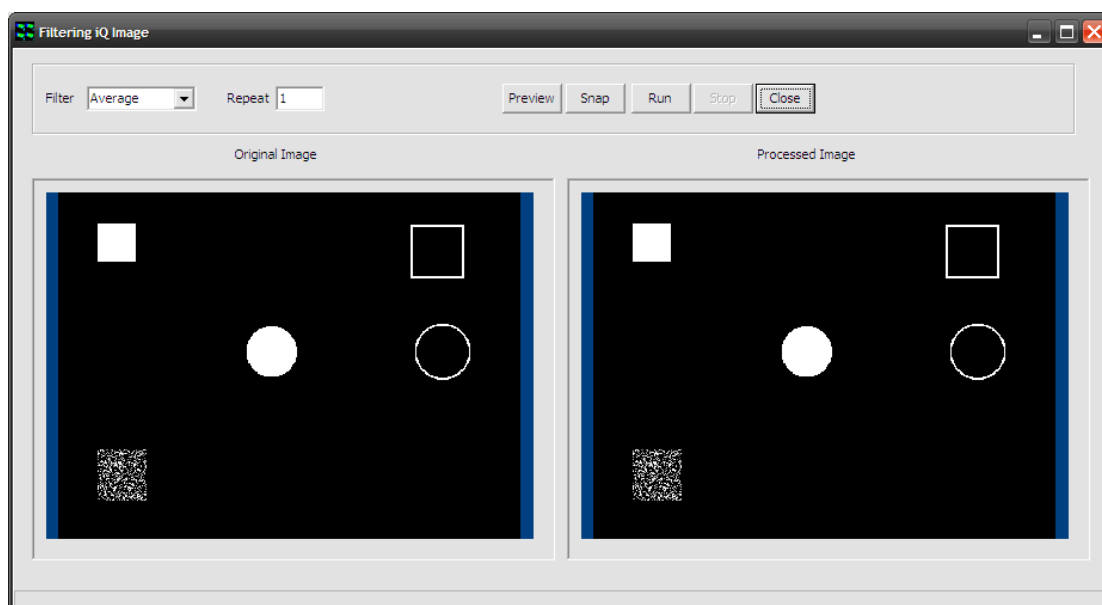

Select the desired filter from the “Filter” dropdown menu. Filters available are Average, Lowpass, Highpass (X), Highpass (Y), 2D Laplacian, Sobel, Prewitt, Sharpen, Median, Dilate and Erode.

Enter the number of repeats in the “Repeat” textbox and press “Preview” to see a preview of the selected filter and repeats in the Image Filter window.

Press “Snap” to load this single image into the ImageDisk and iQ's Main Window.

Press “Run” to use this filter to operate on all images in the sequence and create a new image in the ImageDisk.

Press “Close” to close the Image Filter window. Shown below is the effect of these filters on the test image, although some are difficult to reproduce in print / PDF. Shown also are the 3x3 kernels for each filter.

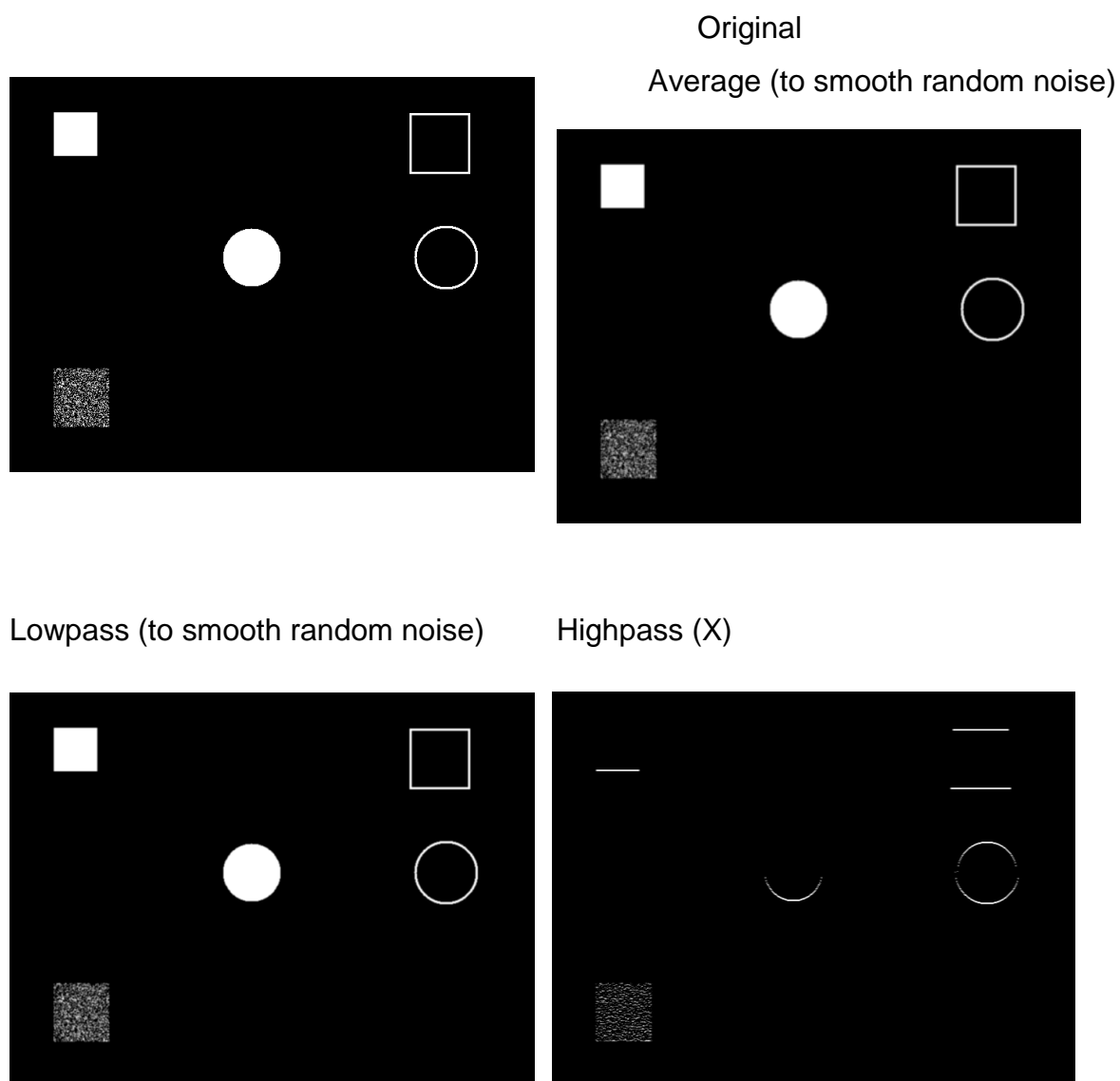

Highpass (Y)



2D Laplacian (edge detection)

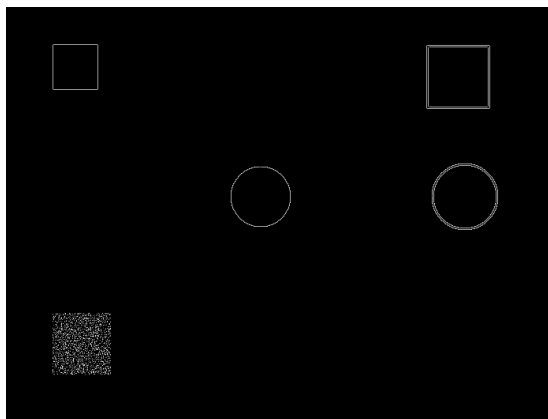

Sobel (edge detection)

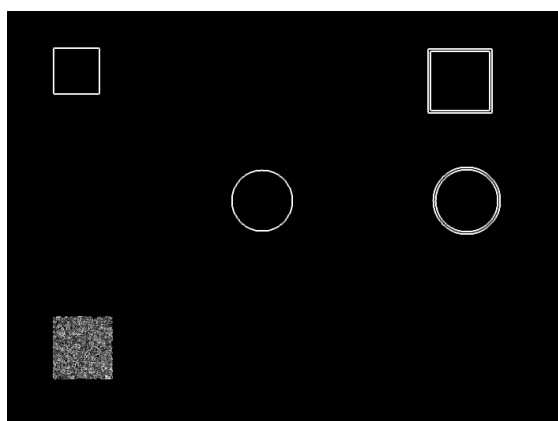

Prewitt (edge detection)

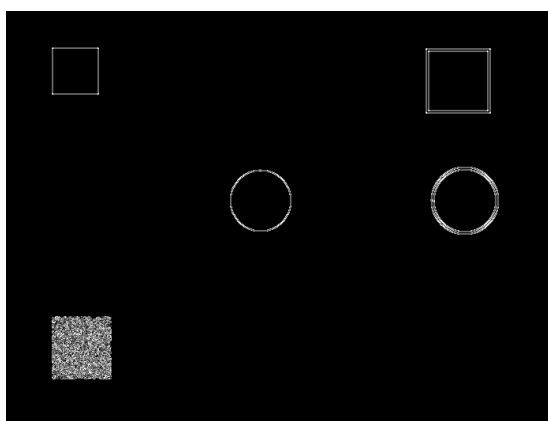

Sharpen

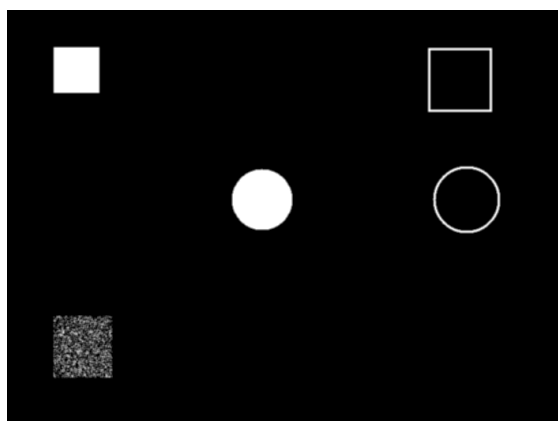

Median

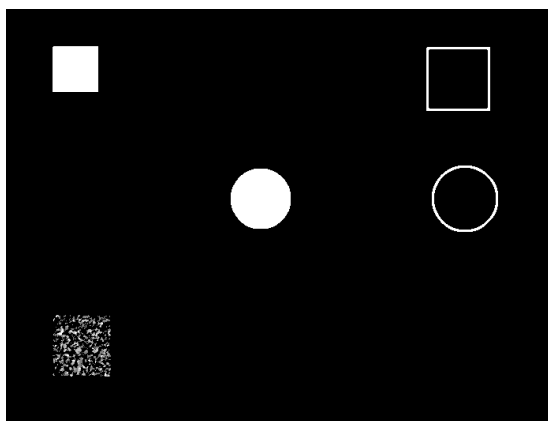

Andor iQ USER GUIDE

Dilate (to expand bright objects or connect pixel groups – left below)

Erode (to reduce bright objects / expand dark objects – right below)

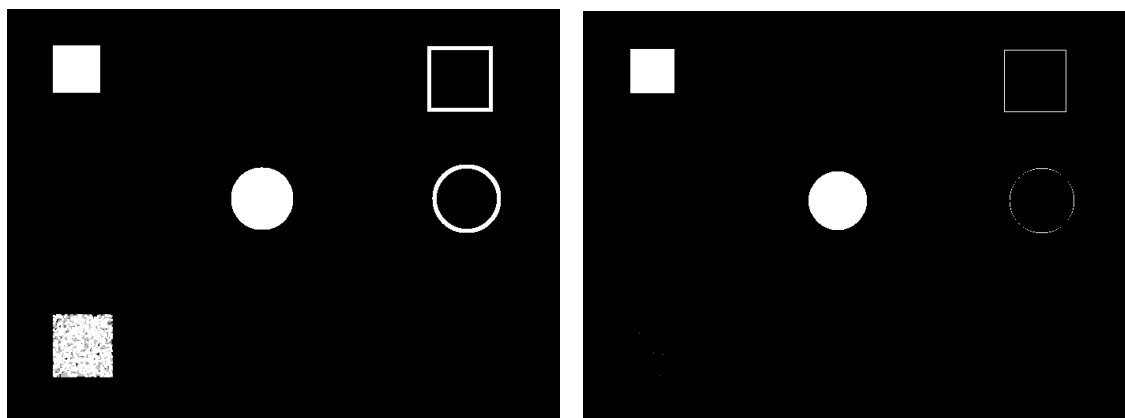

6.6 Rolling Ball Filter

The Rolling Ball Filter can be found in the Process menu in iQ's Main Window. It could be used to isolate single molecules from the background in fluorescence or to correct for uneven illumination in brightfield for example.

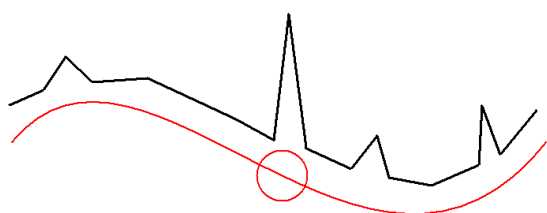
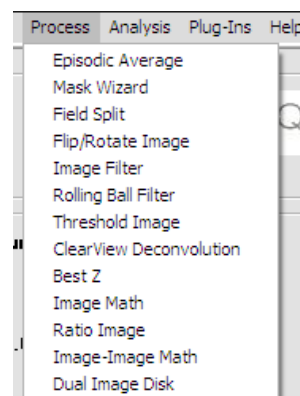

In the above illustration, the concept of a "Rolling Ball" is shown. The black line represents the signal / intensity in the original image. A "ball" is "rolled" along the signal and the centre of the ball forms the signal in the new image. Any signals smaller (spatially) than the diameter of the ball are rejected, irrespective of their intensity. This can be useful to isolate small objects from background, reject small objects or to smooth intensity changes across an image.

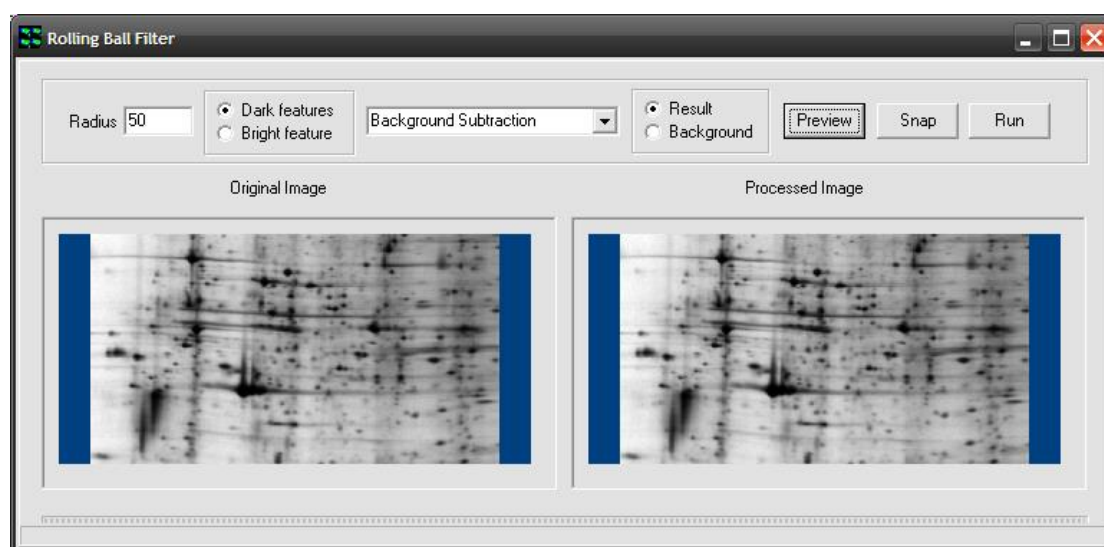

When the Rolling Ball Filter plugin is started, the window will appear and the currently loaded image will be displayed in both the Original and Processed section. Note that the “Processed Image” section is for preview purposes only and may be subject to mapping or contrast changes.

In this image, it can be seen that the background of the gel is unevenly illuminated. To correct for this, a radius larger than the details that should be kept should be entered in the “Radius” textbox. Because this is a brightfield image the dark regions tend to be more of interest, so the “Dark Features” checkbox is selected. Lastly, “Background Subtraction” is selected from the dropdown menu and the “Preview” button pressed to see a preview of the operation in the Rolling Ball Filter window.

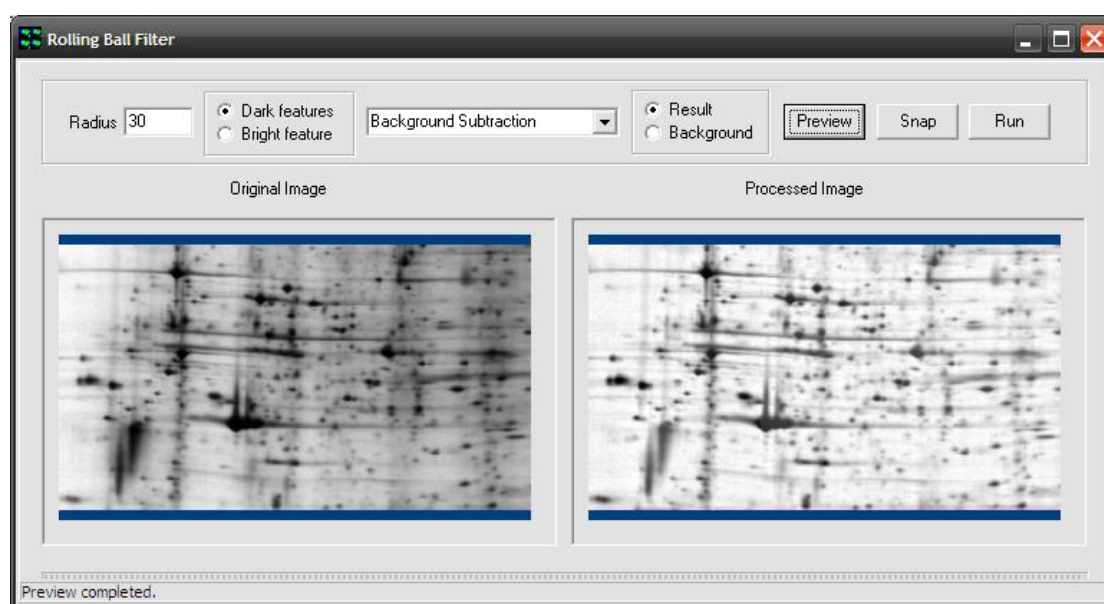

Here, we see that a radius of 30 has been entered and “Dark Features” selected. After pressing “Preview”, the result can be seen in the “Processed Image” section. This is probably an appropriate radius for this image, as the salient features have been retained, whilst removing the uneven illumination across the field.

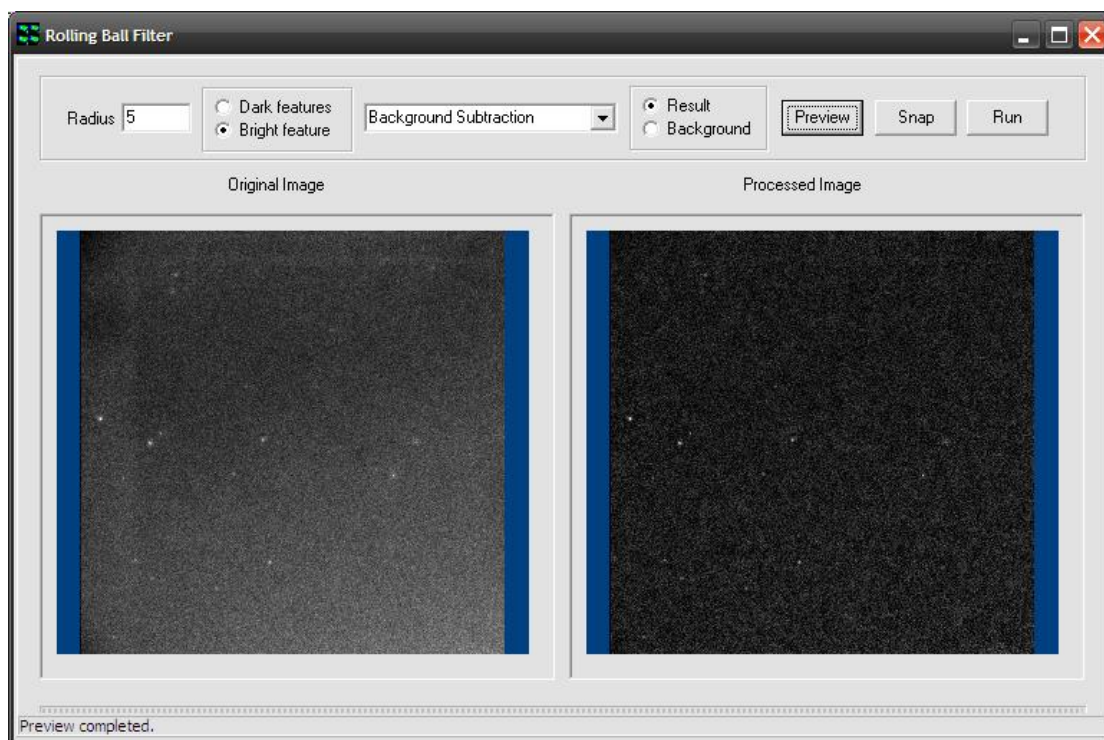

In the example above, single molecules can be isolated from the background by using a suitable radius and selecting the “Bright Features” checkbox.

After adjusting the “Radius” and setting it appropriately for the image, the “Snap” or “Run” buttons can be used to create a single image or operate on all images, respectively.

6.7 Threshold Image

This tool enables a binary mask to be created, which can be applied to any image using standard mathematical operators, prior to subsequent quantification. The mask image enables features of interest to be isolated from unwanted noise in single plane or multi-dimensional series and also provides a source of data for binary image analysis. Note that this tool will perform the thresholds set for each channel through an entire multidimensional data set.

- Episodic Average
- Mask Wizard
- Field Split
- Flip/Rotate Image
- Image Filter
- Rolling Ball Filter
- Threshold Image
- ClearView Deconvolution
- Best Z
- Image Math
- Ratio Image
- Image-Image Math
- Dual Image Disk

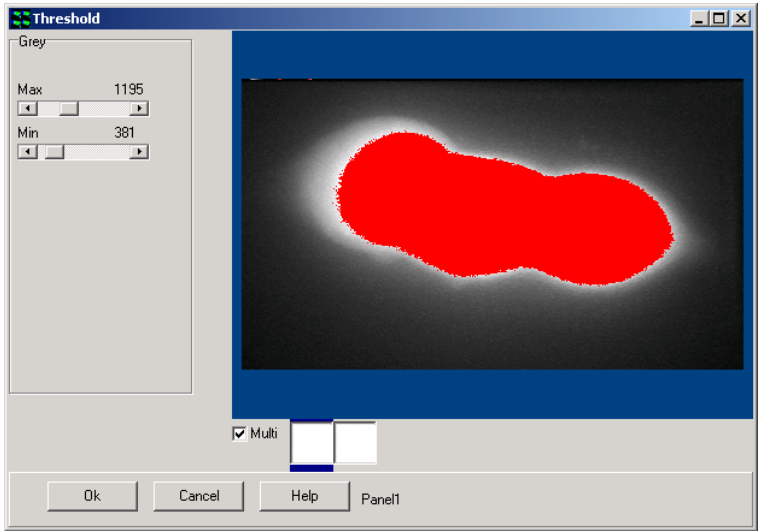

The **Threshold Tool** is accessed from the **Process** menu. Clicking on the selected item launches the set up wizard shown below.

A user-defined threshold is applied to the source image to create a binary mask.

The functionality of this module is identical to that discussed in the section describing the use of the Ratio Tool. Further details concerning the use of the Mask Tool can be found in **Section 6.11**.

6.8 ClearView - Deconvolution

The ClearView deconvolution program is a module, which will function with all Andor products, including Andor iQ, Komet, Komet++ and future products. It is accessed from the Process Menu. Clearview Deconvolution performs deconvolution processing on images of any dimensionality (2D, 3D, 4D and 5D) and delivers resolution enhancement and reduction of out of focus haze. It is therefore aimed at applications where resolution enhancement will deliver significant benefits.



This is especially true in live cell imaging and Cytogenetics:

- i) 3D, 4D and 5D studies of intracellular activity e.g. translocation, signaling and expression;
- ii) FISH and G-band chromosome imaging and spot imaging in interphase cells.

ClearView uses a measured point spread function (PSF) to perform constrained iterative deconvolution processing. The psf is a fundamental feature of all imaging systems and refers to the spreading or blurring introduced by an imaging system, when it is used to image a point object. The image of a point object (e.g. fluorescent bead ~ 0.1 μm) is not a point nor is it constrained to the plain in which the point exists. Using this knowledge and the principle of image formation (called convolution), it is possible to formulate algorithms to reduce the effect of the psf.

The underlying principles of this technique are outlined in the Clearview User Guide.

A flow chart depicting the sequence of steps in the Deconvolution process is shown in **Figure 6.8.1**.

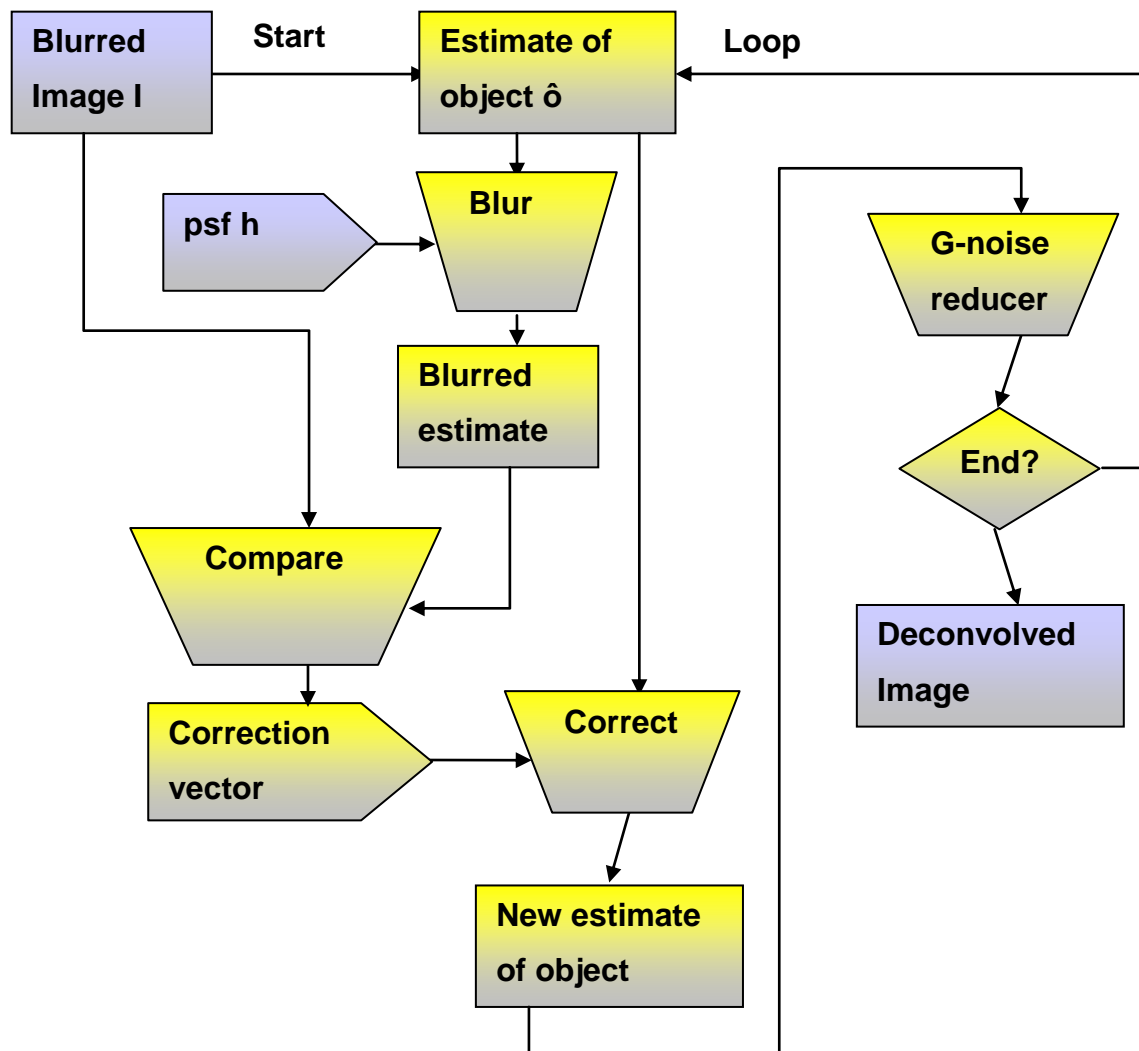
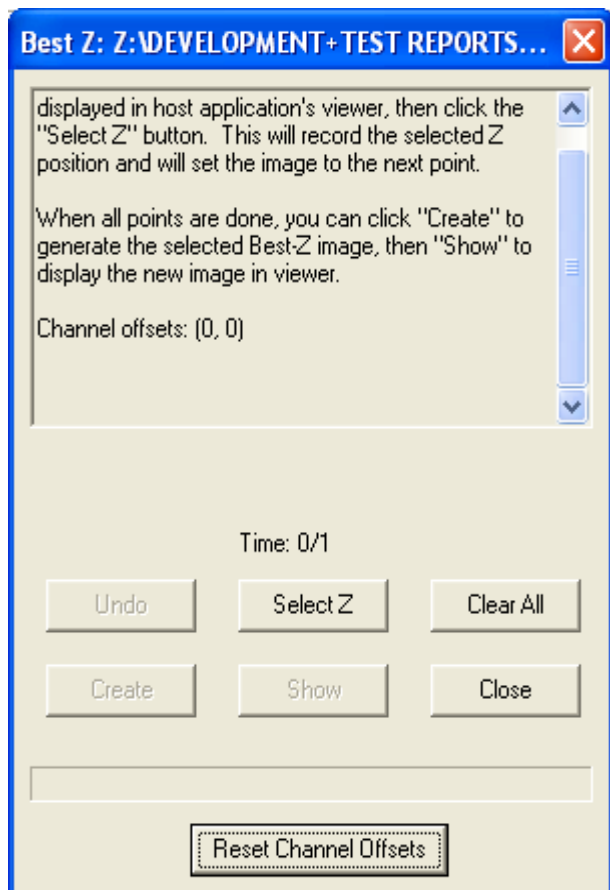
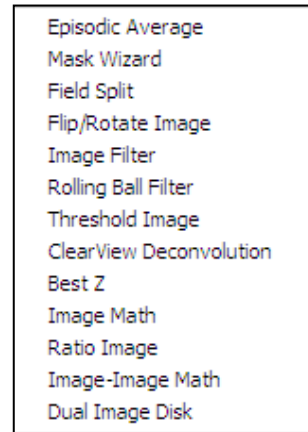

Figure 6.8.1- A flowchart of the Meinel constrained iterative deconvolution algorithm, implemented in ClearView

6.9 Best Z

The Best Z is accessed from the Process menu and is used to select the best z slice from a z-stack image to form a new image whose z dimension has only one point: the one selected by the user



The major use of this tool is for the user to select the best-focused slice from a z stack.

Usually the source image is not only a z stack, but also a time series or even multi-channel time series. Click the channel to set the best Z by moving through the time series. Once satisfied, press the Set button. Continue through each channel.

The Plug-in works on 8, 12, 16 bit grey and 32 bit float and 24 bit color or rev-color images on the image-disk. It requires images with an explicit Z dimension which must have more than one Z plane.

The operation steps are explained for two different cases: single channel image and multi-channel image.

6.9.1 Single Channel Image

When using a single channel image with a time series, follow these steps:

Select a single channel image from the image list.

Select Best Z from the Edit Menu on the Image Window.

Use the Image Navigator at the bottom of the image window to set the Time Tab.

Select the Z Tab on the navigator window.

Change the Z dimension until the best focused slice is found and press the Select Z button on the Dialogue box, as shown in the figure below

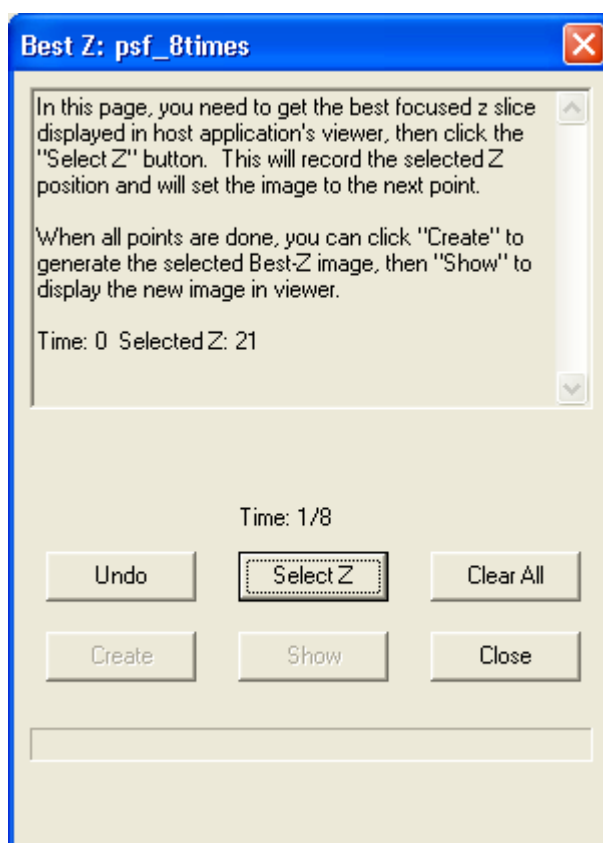

This will write a record in the Memo Box on the upper part of the Plug-in window and advance the time dimension by 1 step.

Select the best focused slice for time 1 and press the Select Z button. Continue to select the Best Z for each time point in the time dimension.

Once all Best Z selections are set, Press the Create button and this will create a new image on the image disk which has only one Z point for each time point, as shown in the figure below

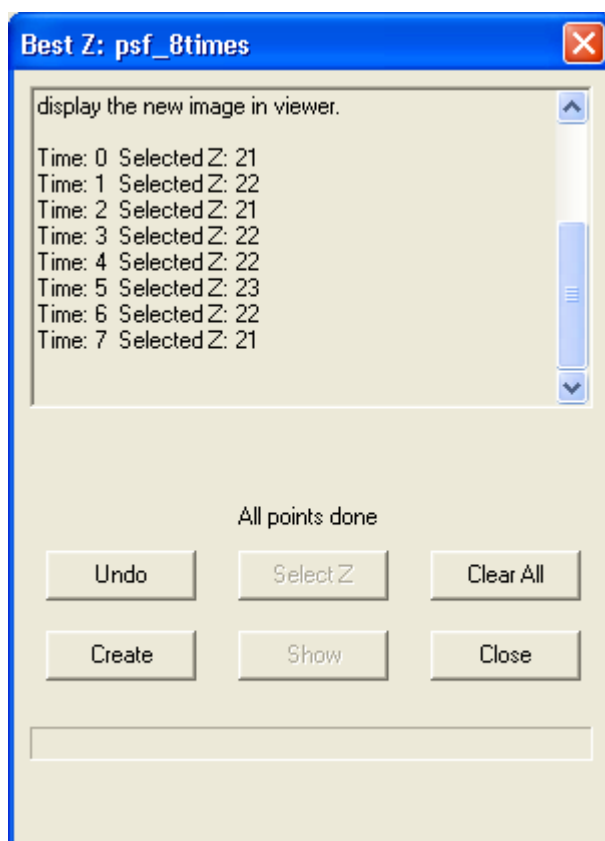

Note: You can use the Clear All button at any time to start over completely or use the Undo button to erase the previous step.

6.9.2 Multi-Channel Image

When using multi-channel image with a time series, follow these steps:

Select a multi-channel image from the image list.

Select Best Z from the Edit Menu on the Image Window, this will start the Best Z with its Channel Offsets Dialog, which is different from the single channel cases.

Use the Channel Selection button to select only the first channel to be displayed in the view.

Use the Image Navigator at the bottom of the image window to set the Time Tab dimension to 0. Select the Z Tab on the navigator window.

Change the Z dimension until the best focused slice is found and press the Set button on the Dialogue box.

Do this individually for each channel in the series as shown in the figure. When all channels are done, press the OK button to finish this dialog as shown.

Now you will be presented with the same Dialogue as in the case of single channels, do it step by step as before for all time points and finally press the Create button and that will generate a new image for you which has only one point in the z dimension.

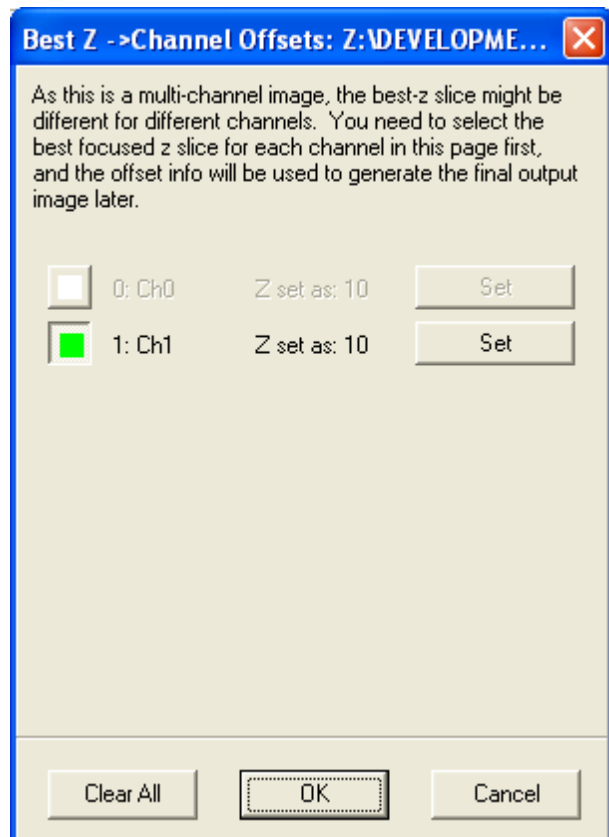

6.10 The Image Math Process

The Image Math Process is accessed from the Process Menu. Image Math operations include addition, subtraction, multiplication and division between a source image and a constant value which produce a destination image. These operations also include Maximum and Minimum intensity projections (MIP's) which are useful in the Z-dimension for extended depth of field and in the T-dimension for highlighting feature tracks. Max and Min Encoded projections (MEP's) are useful in Z for topographic projections and in T for spatial development mapping.

- Episodic Average
- Mask Wizard
- Field Split
- Flip/Rotate Image
- Image Filter
- Rolling Ball Filter
- Threshold Image
- ClearView Deconvolution
- Best Z
- Image Math
- Ratio Image
- Image-Image Math
- Dual Image Disk

Load
Save

When Selected the Monadic Processing window will open.

The user can Load and/or Save Settings by selecting File on the Menu Bar. Select About to view product information.

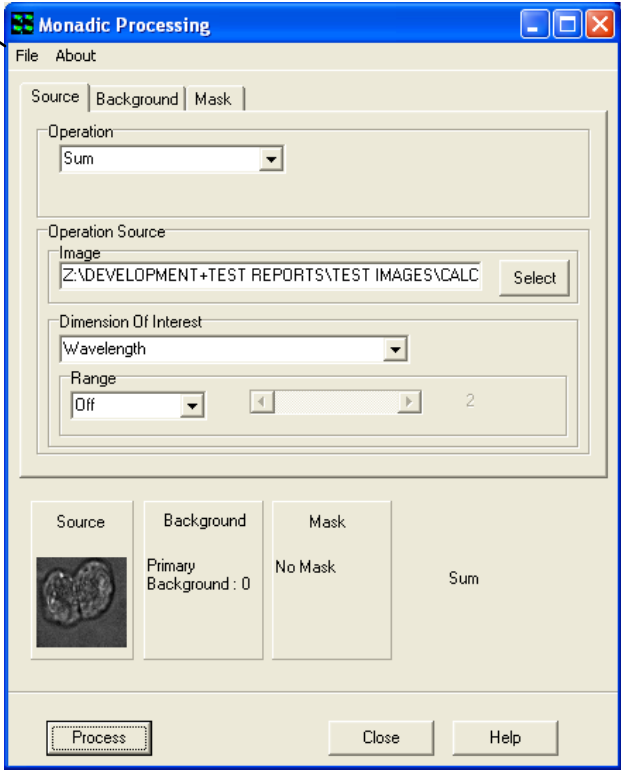

6.10.1 The Source Tab

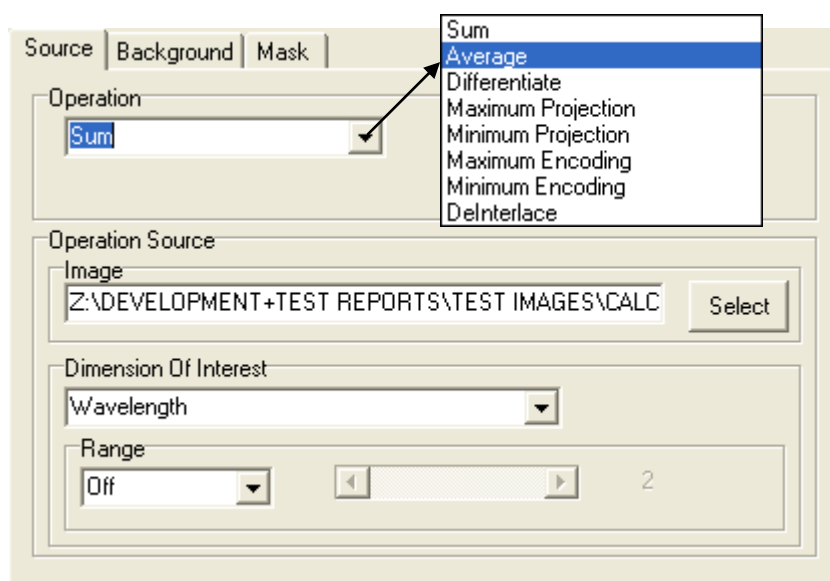

6.10.1.1 Operation

Select an Operation from the Dropdown list as shown.

Sum – This is used to produce a resultant image, whose pixel intensity at any coordinate is equal to the sum of pixel intensities of the input image in the specified Dimension and Range of the selected n-Dim. For more details of modes of operation see Average.

Average – A common processing operation which is used to clean up data. This is not a spatial average, but one applied in the specified Dimension and Range of the selected n-Dim. So it can be used for temporal, Z or Wavelength averaging. Because averaging of this kind can either be “Lumped” or “Running” the user can select which mode of operation is preferred.

Range

E.g. if you have a time-series image of 500 frames and you wish to view the averaged data then you simply choose Time as the Processing Dimension. The Range setting provides another level of control on the Processing.

Range “Off” - the result will be a single frame which shows the average value of all pixels over the 500 frames.

Range “Lumped” - the scroll bar will be activated and you can choose the number of frames over which you want averaging. If you specify 10 frames for example then the result will be a 50 frame sequence in which each frame of the result is the average of 10 frames in the Source. Result frame 1 (R1) will be the average of Source frame 1-10 (S1-10), R2 will be the average of S11-20 and so on.

Range “Running” - again the scroll bar will be activated and you can select the number of frames over which processing will operate. If you specify 10 frames then this time the result will be a 490 frame sequence in which each frame of the result is the “running” average of 10 frames in the Source. Result frame 1 (R1) will be the average of Source frame 1-10 (S1-10), but R2 will be the average of S2-11, R2 = A (S3-12) and so on.

Differentiate – Allows frame by frame subtraction in the chosen dimension. At the most basic level, in a time series you can produce a frame by frame difference and choose to subtract the first image from the second ($I(i+1) - I(i)$) or the second from the first ($I(i) - I(i+1)$).

Maximum Projection – This is a maximum intensity projection, in which each pixel in the Result is maximum intensity pixel (same XY position) in the dimension and Range selected. Range works in the same manner as described above for Average.

E.g.: This tool is useful for extended focus observation with Z series of fluorescent specimens or for highlighting feature tracks in T-series. There are many other uses.

Minimum Projection – This is a minimum intensity projection, in which each pixel in the Result is the minimum intensity pixel (same XY position) in the dimension and Range selected. Range works in the same manner as described above for Average. This tool is useful for extended focus observation with Z series of bright field/stained specimens or for highlighting feature tracks in T-series. There are many other uses.

Maximum Encoding – This is an encoded projection, in which each pixel in the Result is replaced by the dimension coordinate at which the maximum intensity pixel occurs (same XY position) in the dimension and Range selected. Range works in the same manner as described above for Average.

E.g.: These Encoding tools are useful for creating a Max or Min transmission or emission wavelength map in a spectral image series. They can also be used for topographic surface mapping in a Z, where the pixels are replaced by the Z coordinate where they appear brightest (or dimmest), or are in maximal focus. In time-series analysis feature tracks can be time-encoded at each location and the local slope of a track in time will show instantaneous speed.

Minimum Encoding – This is an encoded projection, in which each pixel in the Result is replaced by the dimension coordinate at which the minimum intensity pixel occurs (same XY position) in the dimension and Range selected. Range works in the same manner as described above for Average.

DeInterlace – This process is normally applied to data from RS170 or CCIR analog video images. These types of cameras, used for many decades in CCTV, produce an image by scanning two “fields” (which consisting of the odd and even lines of the image) sequentially and then displaying or outputting them for display on an analog video monitor. The frame rate of these cameras is 30 fps (RS170 US Standard) and 25 fps (CCIR European Standard), but the field rates are 60 and 50 fields per second, respectively. This means that two fields are acquired per frame and they are actually “interlaced” in time when they are displayed. The eye cannot detect this effect, but with digital processing and analysis it can be a problem. This function allows each interlaced frame to be separated into two fields, with half vertical resolution, but twice the temporal resolution.

6.10.1.2 Operation Source

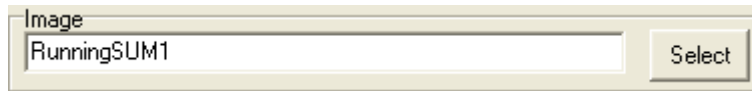

Select an image to use. This will default to the image currently in the Image Window. Press the Select button to choose a different image. This will open the

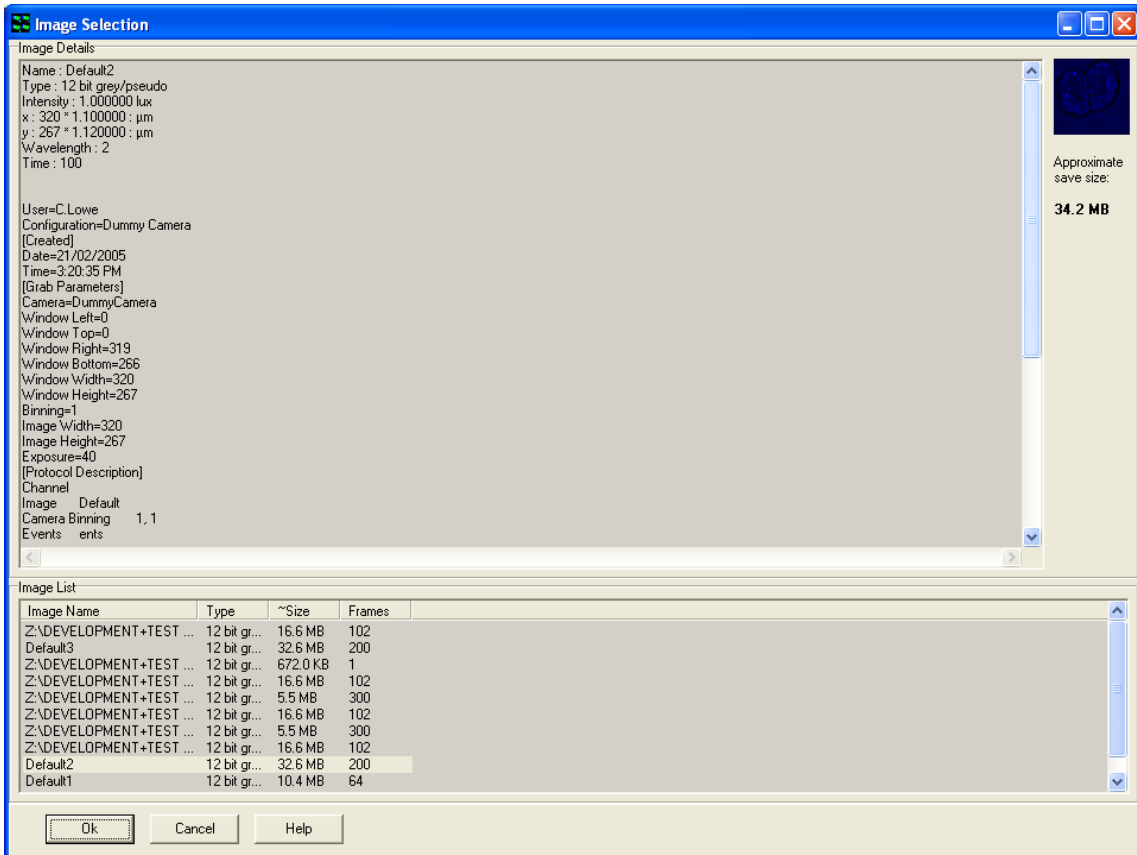
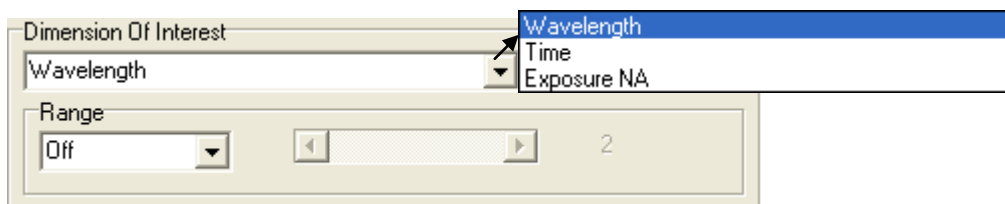

Image Selection Window. Highlight an image from the image list and press **Ok**.

6.10.1.3 Dimension of Interest



Select the Dimension of interest from the dropdown list and then select the type of

Range from the drop down list.

6.10.2 The Background Tab

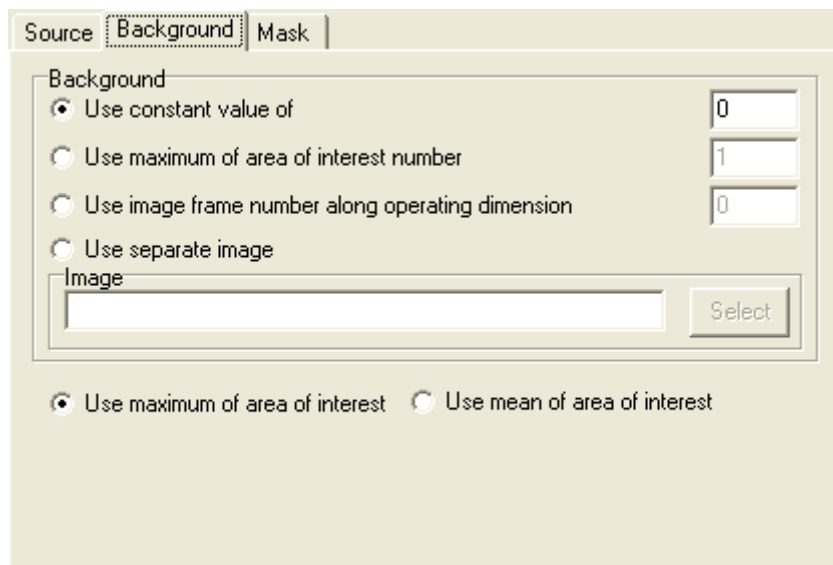

Background A/Background B

This tab is used to specify the Background Correction Values which will operate before the primary mathematical processing is started, Background correction will subtract the value specified in the selection from each pixel in each image prior to the calculation. Options included are:

- A constant value can be specified.
- Maximum or Mean of a numbered Region of interest.
- One frame from the Source Image(s) A/B.
- A separate image in the image list can be used.

Select one of the options and type a value into the text box for both A and B if applicable. If Use separate image is selected use the select button to choose an image from the image list.

6.10.3 The Mask Tab

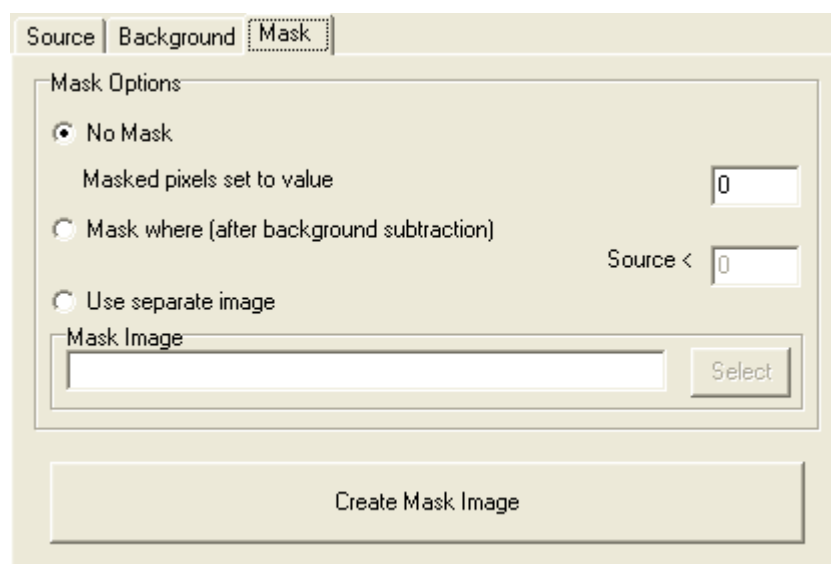

A Mask defines the region over which the processing will be executed. It is a binary result of a pixel by pixel comparison against a constant value (Mask where...) or it is a binary image or image series. Whenever the result or image is “1” the calculation will be executed, otherwise the pixel in the Destination image will be set to “Zero”. This ensures that processing will be constrained to regions of the image where there is useful information and not background noise.

Select **No Mask** if a mask is not being used.

Select **Mask where (after background subtraction)** if you know the values you want to use.

Select **Use separate image** if you would like to create a mask with another image. Use the select button to select another image from the image list.

Select the **Create Mask Image** to create a mask. This will launch the Mask Wizard (Section 6.1.2).

6.10.4 Processing Summary

Each option selected under the Source, Background and Mask Tab will be previewed at the bottom of the Monadic Processing Window as shown below.

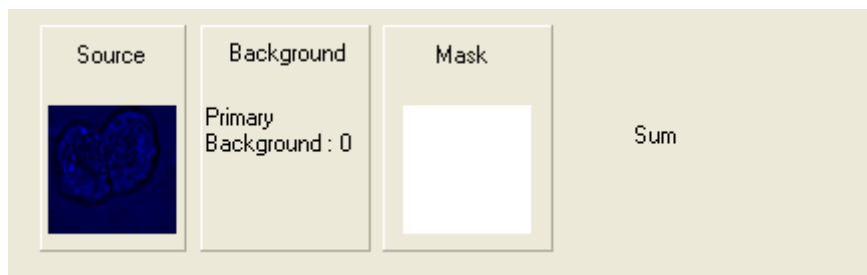

Close Press the close button to exit the Plug-In.

Help Press the Help button to access section reference for User Guide.

Process
Once all selections have been made under each tab, press the **Process** button. A new window will open as shown on the right. If **Display Current Image Slice** is selected a live preview will show in the window. Press **Cancel** at any time to exit setup. The new image will then be added to the image list.

Once the processing is complete the new Destination Image will appear in the ImageList from where they can be shown and selected for other processing.

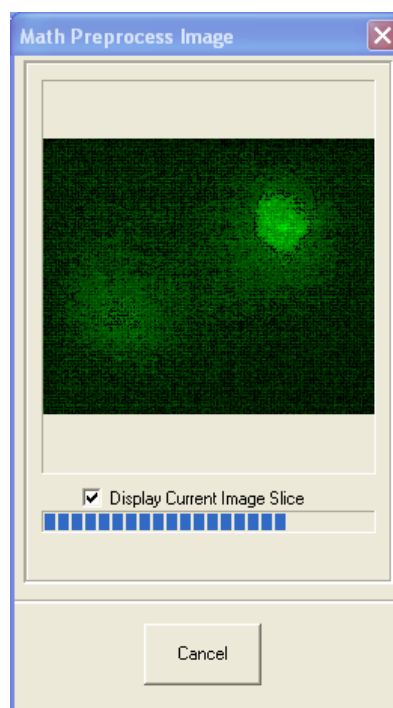

6.11 Ratio Image

The Ratio Image Process enables rapid and precise post-processing of single and multi-wavelength images from specimens loaded with fluorescence indicators. These include ratiometric indicators, such as Fura2 for Ca⁺⁺ concentration measurements and donor-acceptor (e.g. CFY-YFP) coupling for FRET (fluorescence resonance energy transfer) imaging, as well as normalization techniques for single wavelength intensity modulating indicators.

Ion concentration and FRET interaction measurements can be directly determined from images in a simple yet comprehensive user interface. Measurements can be performed on single plane and multidimensional image data. The example image below shows a triplet of HEK cells, loaded with Fura2, which were stimulated with acetylcholine resulting in temporal fluctuations in calcium ion concentration (courtesy Paul Thomas, Department of Pharmacology, University of Cambridge).

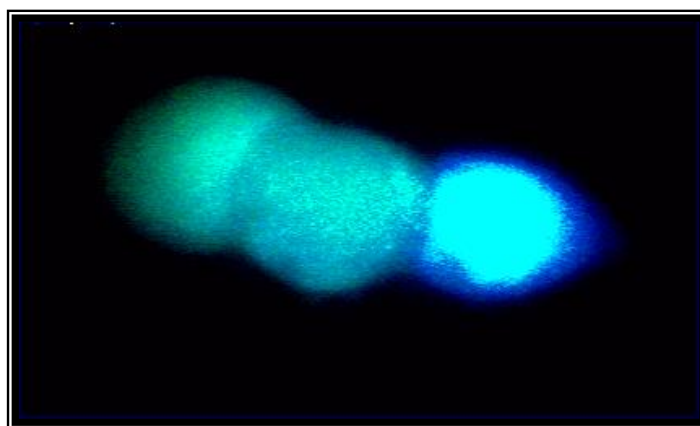

Ratio measurements can be carried out on images that have been previously loaded or acquired into the iQ. Following the specification of appropriate source image(s), ratio mode, image background and masking operations, the Ratio output delivers floating-point images, which directly map ion concentrations at the press of a button.

6.11.1 The Ratio Tab

The Ratio tool is powerful and flexible and can be adapted to many experimental set-ups. It provides four different ratio methods, four background correction techniques, mask creation and mask processing and calibration by either Almers-Neher or Gryniewicz-Poenie-Tsien equations to deliver calibrated ion concentrations in single cells.

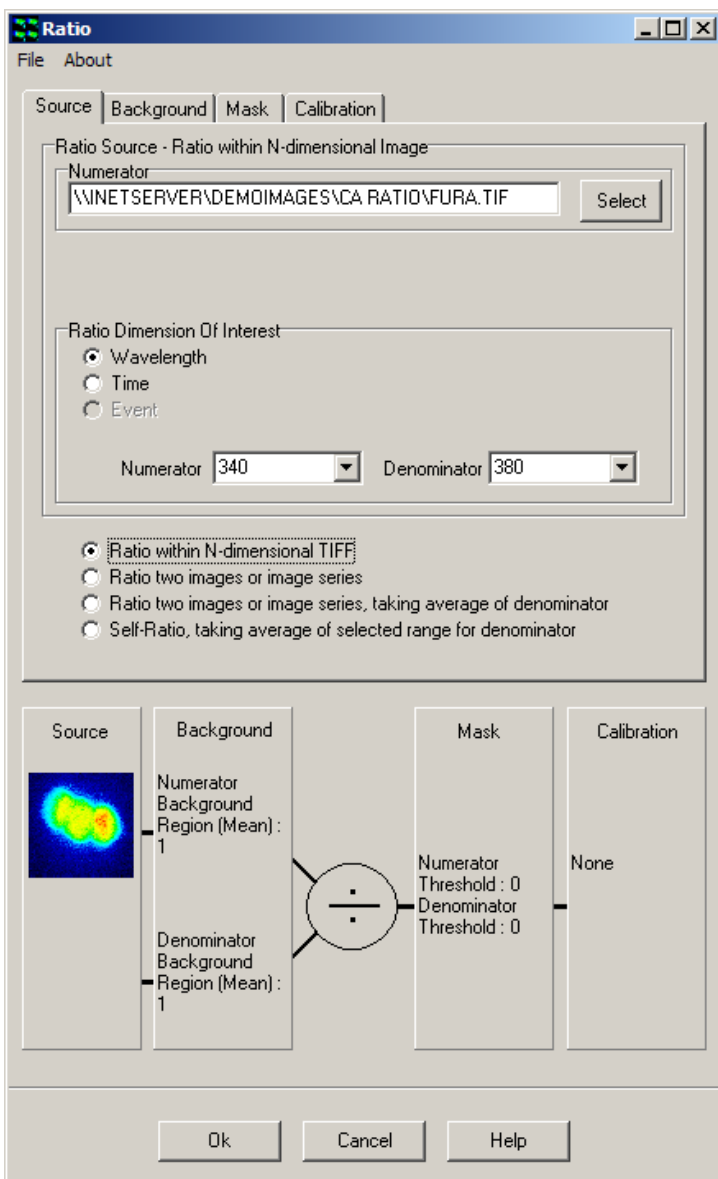

A given configuration is referred to as a transformation, which can be saved and loaded to/from file via the Settings menu for easy re-use. The graphic in the dialogue reflects the current transformation. The resultant floating-point image series are stored to the Andor ImageDisk and can be interrogated using various tools, including through-series analysis for characterization and quantification of intra- and inter-cellular dynamic processes.

The ratio tool is accessed by selecting the **Process** option from the iQ menu and clicking on the **Ratio Image** item.

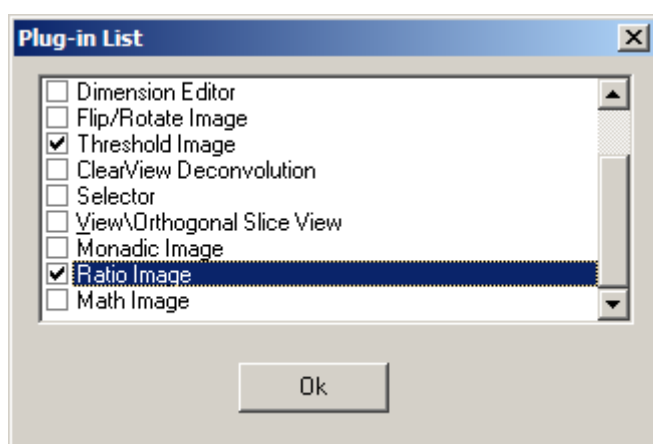
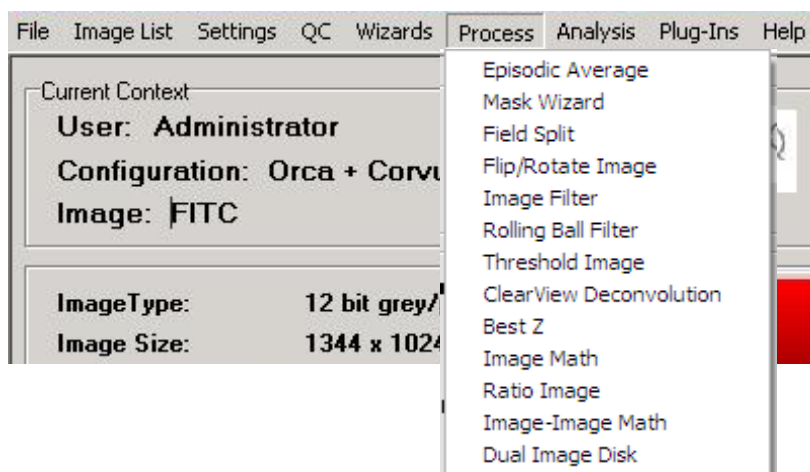

The use of the ratio tool is explained with the aid of the dual wavelength time-series data of HEK cells, mentioned previously, and loaded with Fura2, the most widely used excitation ratio indicator for calcium. The data set comprises two hundred time frames with two corresponding wavelengths of 340 and 380nm, respectively.

The first frame at 340nm is shown above and was acquired using iQ with a Monochromator as the excitation source and a Hamamatsu 4880-80 camera.

6.11.2 Source

Images to be ratioed are selected within the Source dialogue. Clicking on the Source tab reveals the panel displayed below.

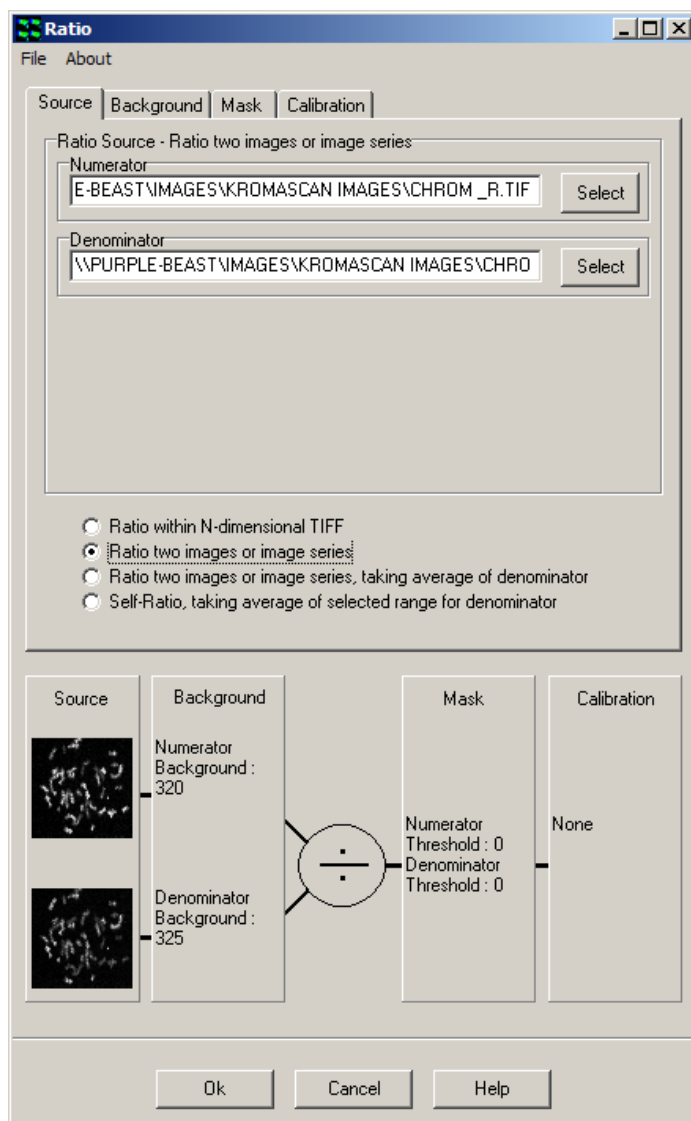

Four ratio methods are accommodated by the ratio tool and are selected using the appropriate radio button:

- Ratio within N-dimensional TIFF;
- Ratio two images or image series;
- Ratio two images or series, taking the average of the denominator;
- Self-Ratio, taking the average of the denominator

The method selected determines how the image processing proceeds and the different experimental situations where each method would be appropriate are discussed here. When we mention image-series, bear in mind that this is a times series, but can also refer to single frame images.

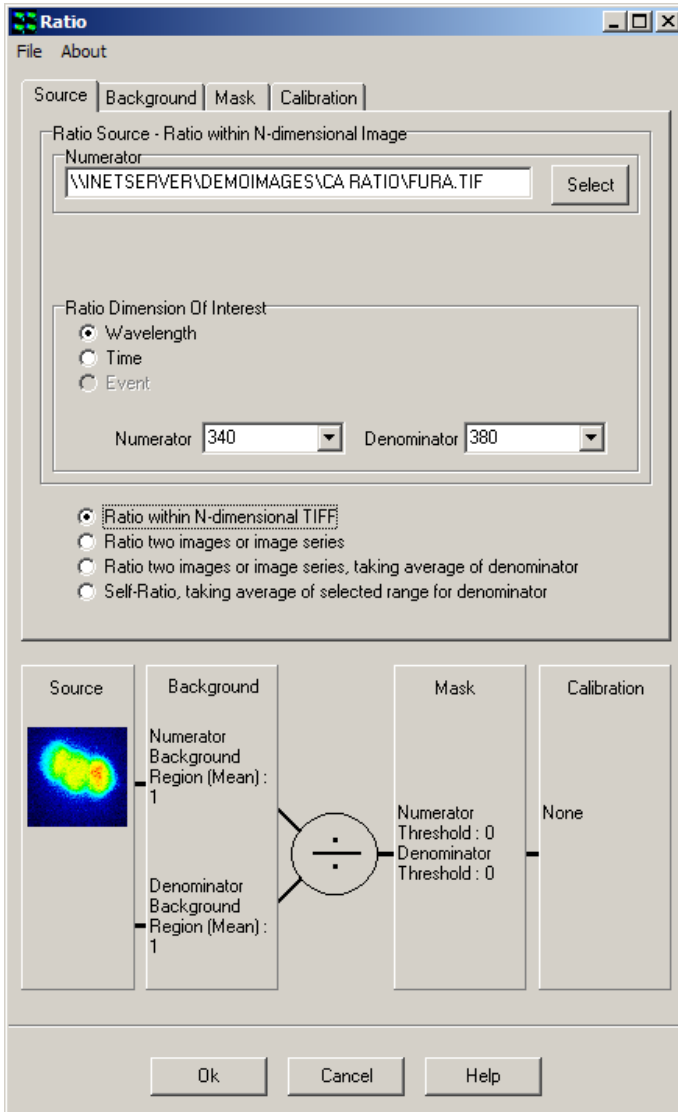

Method one, illustrated in this dialog, uses an nDimensional image (nDim) as its source, as produced by AQM, in which two channels or wavelengths series are recorded in the same nDim. The user specifies which channel is used for numerator and denominator. In this case the ratio of 340 to 380 nm is to be computed. In this case note that only one source image is displayed in the configuration graphic. This is the classical dual wavelength ratio approach. Because of the capture method in AQM, the resultant image series will be the same length as the original nDim.

The second method takes a ratio between two image-series, such as one might load from a third party capture software, using the multi-load facility in AQM. If the image series are not of the same length, the resultant image series will be:

The length of the smaller of the two sequences and the additional frames in the longer sequence will be ignored except where one of the images is a single frame, and then the result will be the length of the longer sequence.

If one of the Images is a single frame, the single frame will be used as the numerator or denominator in all ratio operations.

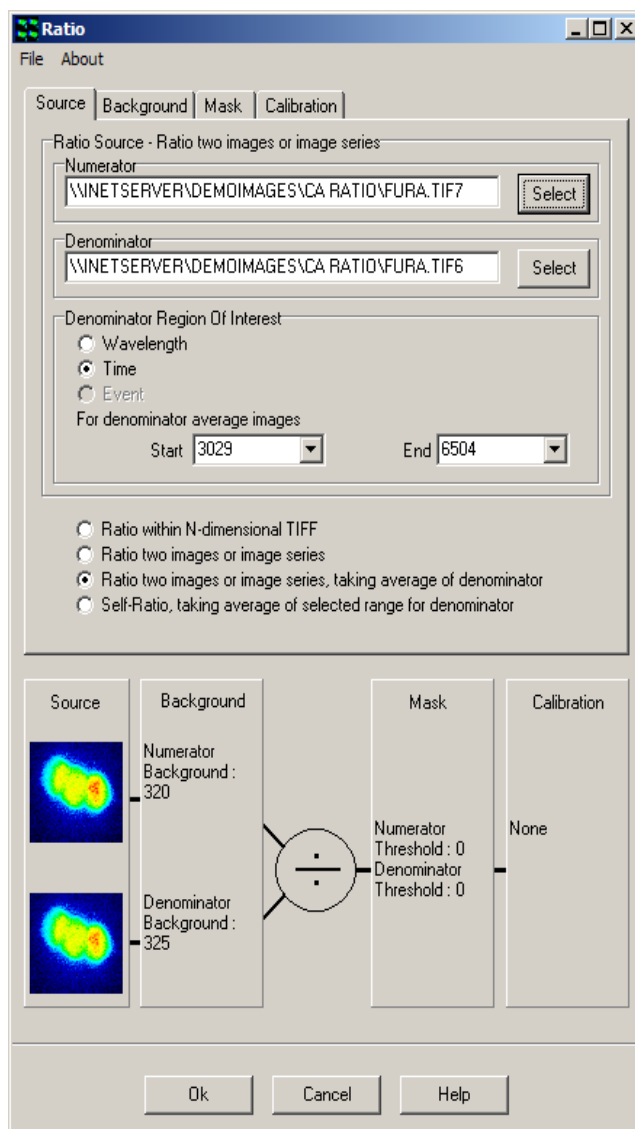

The third method, illustrated in this dialog, behaves in a similar way to method 2, except that the user-defined frame range in the denominator image will be averaged. The average is used as the denominator for all ratio operations. The Dimension selection for denominator range will almost always be Time. An example of where this method is appropriate is outlined in **Section 4.8.4**, where a protocol is developed for baseline imaging, followed by compound UV uncaging and then fast imaging of a single wavelength indicator. The fluorescence fluctuations monitored in this protocol can be normalized to the baseline level using the second method. The resultant series length will always be that of the numerator.

Method four (not illustrated) is applicable to single wavelength indicator experiments (more than one indicator can be handled in one experiment), where some period of the series is used for a baseline normalization, similar to method three above. The main difference here is that the image series contains both the baseline frames and the frames for normalization. The user interface needs the baseline line frame range (denominator) to be specified.

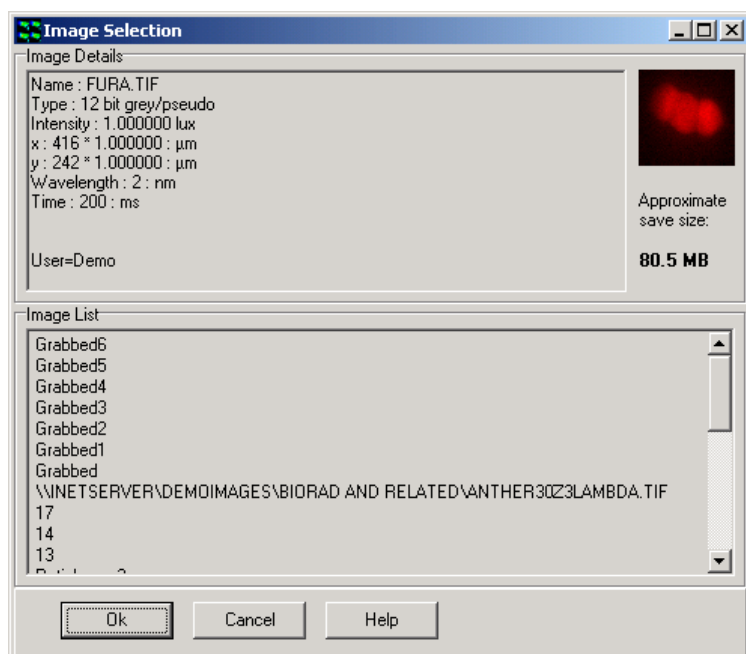

For the example image series of the HEK cells, we are interested in the change of calcium ion concentration with time. To process this image, we must first select the ratio **method one** and then select the image from the Image List by clicking the **Select** button.

The dialog shown here will be displayed, where images can be checked and selected. Note that images must already be loaded into iQ. Once selected the image name (Fura2) is set into the Source Image box and a thumbnail of the image is shown on the graphic.

The **Ratio Dimension Of Interest** is set to **Wavelength** by clicking on the appropriate radio button. The wavelengths for the ratio are input into the respective **Numerator** (340nm) and **Denominator** (380nm) text boxes using the two dropdown lists. Then the background correction method can be selected as discussed below.

6.11.3 Background

Following definition of the ratio source and dimension of interest, a background correction method must be specified for the numerator and denominator images

before proceeding to the next stage of the transformation set up.

Clicking on the **Background** tab reveals the panel displayed below.

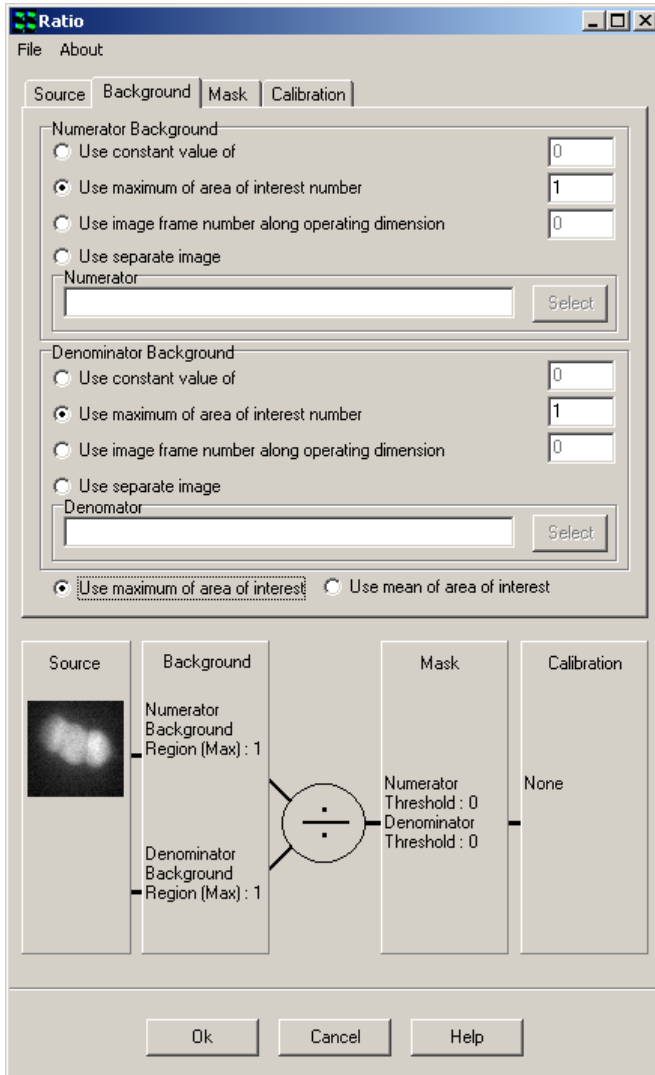

Four methods of background correction are available for the numerator and denominator. Any method may be selected by clicking on the appropriate radio button.

Use constant value of performs a background correction by subtracting a fixed value from each pixel; a value for the constant is typed into the text box. This is normally computed from average background intensity

Use maximum of area of interest number subtracts the maximum pixel value in a user-defined region of interest (ROI) from each pixel. The ROI used for background

correction is specified by typing the required ROI number into the text box.

Use mean of area of interest number subtracts the mean pixel value in a user-defined region of interest (ROI) from each pixel. The ROI used for background correction is specified by typing the required ROI number into the text box.

Note: The ROI must be placed on the image before opening the Ratio tool, or by closing it and then drawing a rectangular background ROI on the image.

Use image frame number along operating dimension subtracts the appropriate image from each frame in a time series. Typing the frame identification number into the text box specifies the frame required for the correction procedure.

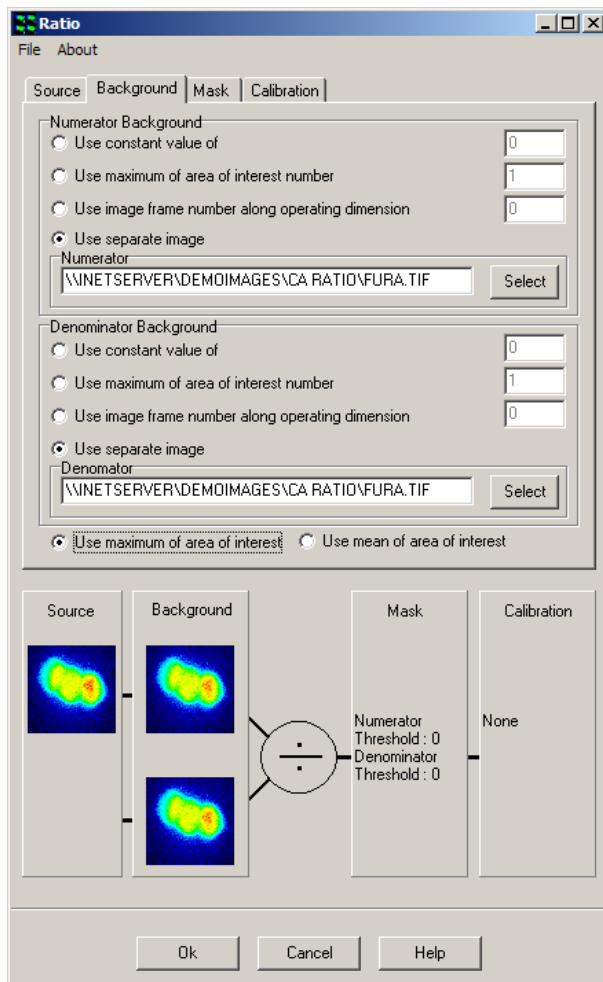

A separate image independent of the time series can also be selected using the **Use separate image** option. The background image is selected from the Image List by clicking on the **Select** button or by typing the designated file name into the text box.

For the HEK cell example, the second background correction method has been chosen for both the numerator and denominator. In this case an ROI has been drawn in a background region of the image. Now as each frame in the series is processed, Ratio tool computes the maximum intensity in the ROI and subtracts it from all pixel values in the frame to remove the background. This is done for the 340nm and the 380nm images independently, so each is background corrected from the image of the appropriate wavelength.

6.11.4 Mask

Clicking on the **Mask** tab reveals the following panel.

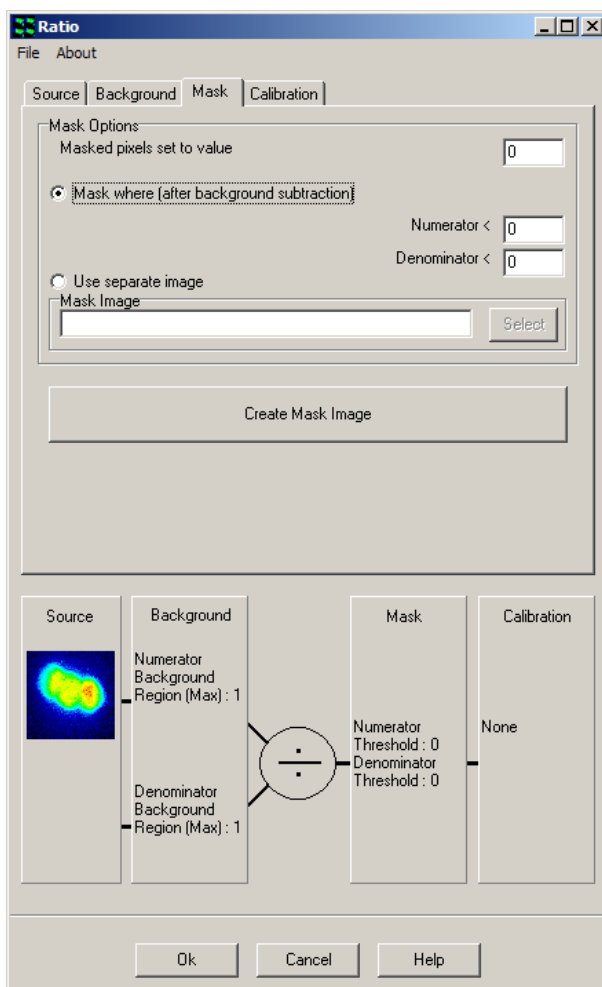

The Mask operation is used to reject ratio data or image pixels that lie in background or low intensity regions of the image where noise and flare and other artifacts can give rise to spurious results. The user can define to what value the rejected or masked pixels are set by entering the value into the text box provided at the top of the dialog.

There are two methods available to apply masking. The first is to ignore pixels with a low value e.g. 0 as shown here, but you may wish to set it to some value well above the noise expected after background correction. Depending on the image detector used this may be from 5-50 grey levels.

The second method uses a binary image, usually created with a thresholding tool (see next section) from the original data set. Then in areas of the binary image, with value zero, ratio processing is inhibited and the pixels set to the value specified by the user. Creation of this binary mask image is handled through the mask wizard, which is launched by clicking on the **Create Mask Image** button on the dialog shown above and is described in the next section.

6.11.5 Create Mask Wizard

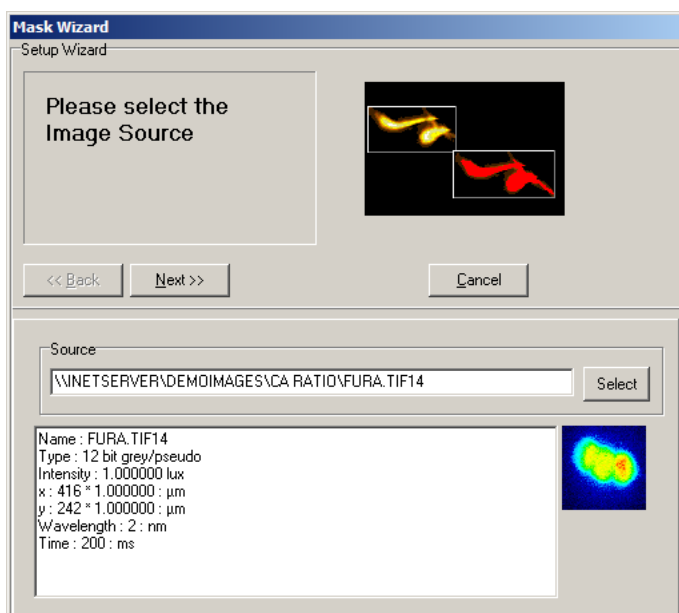

When you create a mask image, a wizard is launched and the dialog shown here appears. At this point you select an image from the Image List to create the binary mask. In this case the Fura2 image is used. In general this will be the most common approach. Then click on the Next button.

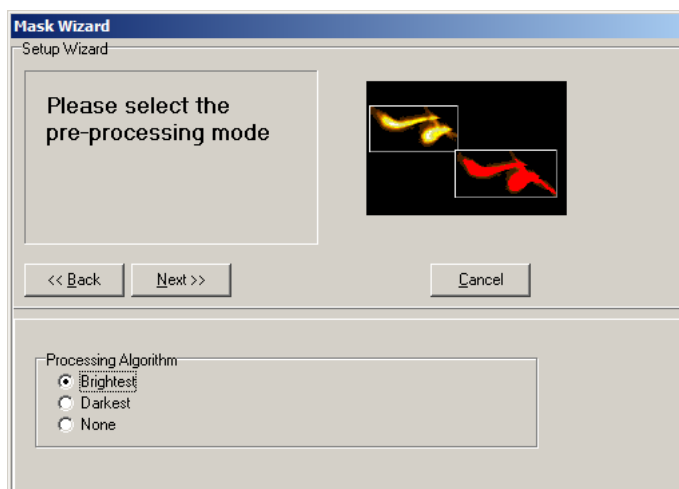

Some pre-processing can be applied to the image series before thresholding to create the mask. When a time series contains cells that are static in the field of view, we recommend use of the Brightest algorithm. Alternatively for moving cells then select none.

The brightest processing function creates an image, which is maximum intensity projection (through time in this case) for each pixel. The resultant image makes a suitable source for a mask and ensures that all regions, which show activity at any time in the series, will be ratio analyzed.

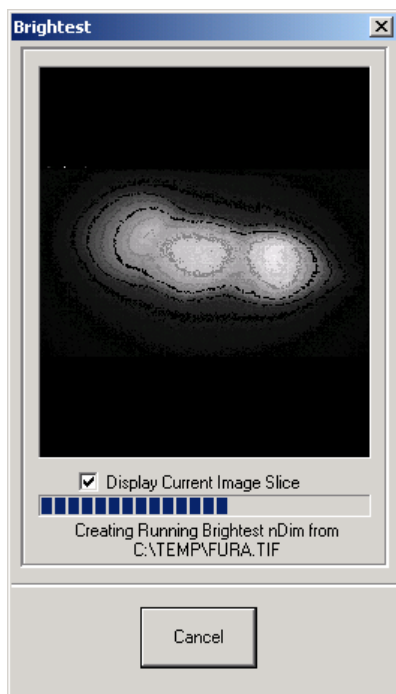

If you choose the Brightest processing the mask source image will be created, showing this progress dialog as it is processing.

The mask source image is converted to binary by a threshold operation as shown below. The scroll bars are used to select the accepted intensity range for the binary image.

If the Brightest processing was performed the result will be a single mask at each wavelength (shown left). This is best for this example of stationary HEK cells.

If **None** is selected, then the system produces a time series mask in which the image

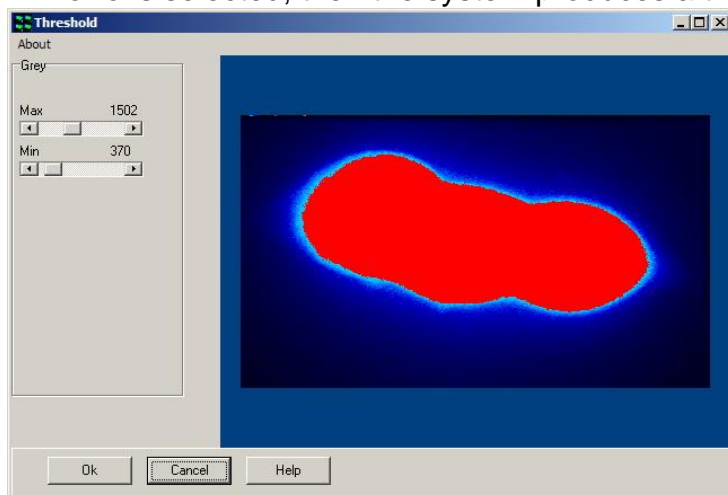

at each time point is thresholded, and a unique mask at each time point is used. So the mask is a threshold with time, making it suitable for masking moving cells. Once you click **OK** in this dialog, the mask wizard shows its final page for confirmation of the mask

creation and we then move to setting up the calibration phase if it is required.

6.11.6 Calibration

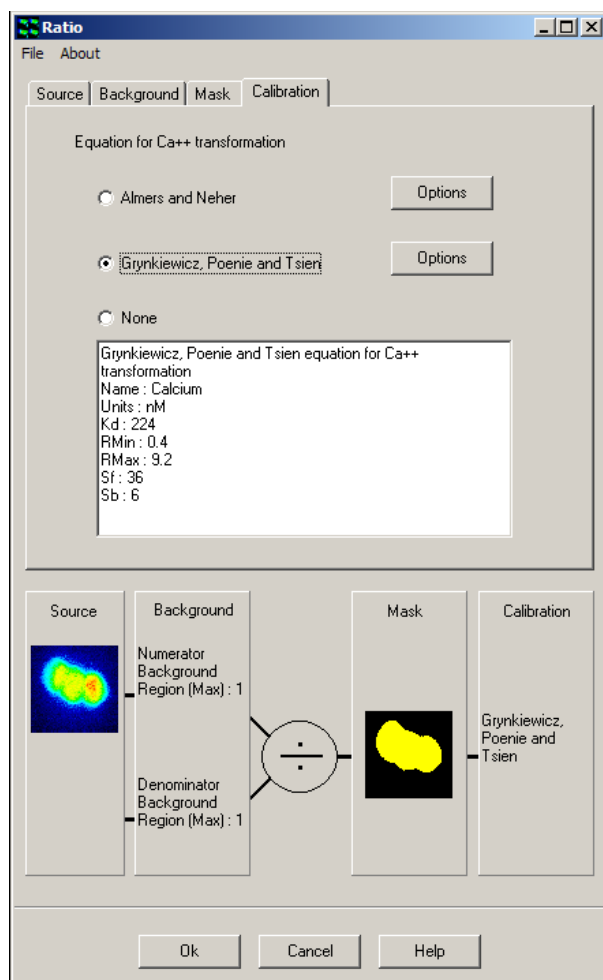

Clicking on the **Calibration** tab reveals the panel opposite. Following ratio, background correction and masking, a calibration can be applied to the floating-point ratio image to convert individual pixel intensities to values of ionic concentration.

Two different calibration procedures are available, the **Almers and Neher** method or the **Grynkiewicz, Poenie and T sien (GPT)** transformation. Either may be selected using the appropriate radio button.

The GPT transformation is expressed as follows:

$$[Ca^{2+}] = K_d \left(\frac{R - R_{min}}{R_{max} - R} \right) \left(\frac{S_{f2}}{S_{b2}} \right)$$

where R is the ratio recorded under appropriate physiological conditions.

Rmin is the ratio recorded at zero external Ca²⁺.

Rmax is the ratio recorded in excess external Ca²⁺.

Sf2 / Sb2 is the ratio of the signal at 380nm (Sf2) in zero Ca²⁺ to that in the presence of excess Ca²⁺ (Sb2).

Kd is the apparent dissociation constant for the indicator (usually taken as 224 nM for Fura-2).

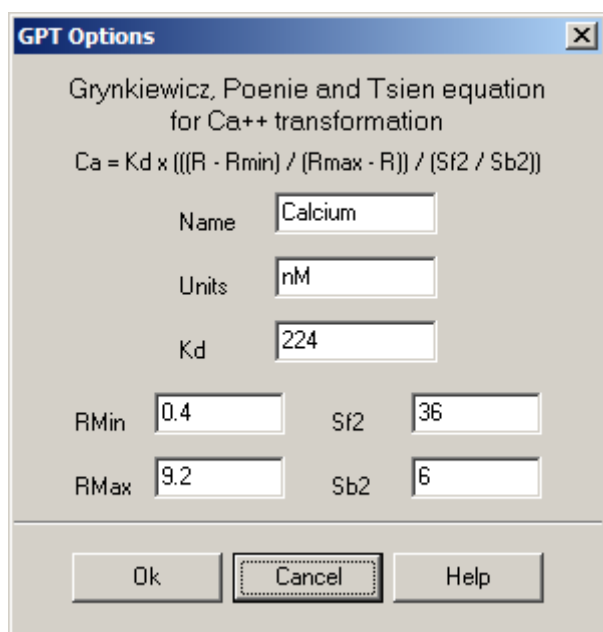

These values are settings you must determine for your own imaging setup and are used during the calculation of Ca²⁺ concentrations. The actual values for these parameters are set up in a dialog box like this one. The Almers Neher method has a similar dialog box.

For the HEK cell example the following values have been established:

Rmin = 0.41, Rmax = 9.26, Sf2 = 36, Sb2 = 6 and Kd = 224 nM.

The equation for the Almers and Neher method is expressed as follows:

$$Ca^{2+} = K^* ((R - Rmin) / (Rmax - R))$$

The constants used during the calculation of Ca²⁺ concentrations are as follows.

K* = 1819, Rmin = 0.41 and Rmax = 9.26.

Selecting the **None** option does not apply any calibration to the ratiometric image, a floating point image of the ratioed wavelength intensities will only be displayed, the pixel intensities not expressed as values of actual ion concentration.

Once a transformation has been defined as described above, the calculation of ionic concentrations is performed by clicking the **OK** button at the bottom of the Ratio panel.

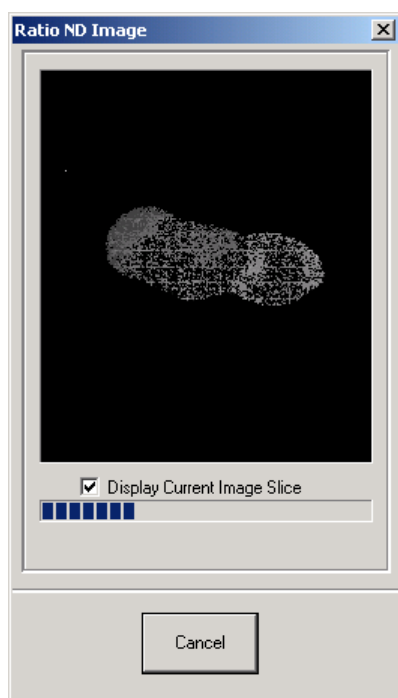

A floating-point ratio image is generated for each time point in the temporal data series and the appropriate calibration applied, to enable the conversion of individual pixel intensities to ionic concentrations. The progress dialog shown here is displayed as the processing may take a little time. On completion of the calculation, the resultant ratiometric image is displayed in the Image Window.

6.11.7 Analysis of Temporal Data

The ratiometric time series can be studied in the Analysis Window and statistics calculated for individual time frames or within user defined regions of interest (ROIs). The use of the analysis functions available within Andor iQ has been described previously in **Section 4.6**. Results from the example image series are presented below.

Three images are displayed, together with statistical plots showing the mean brightness computed from corresponding user defined ROIs positioned at three different locations on the ratiometric image. Examination of the statistical plots reveals a significant difference in the dynamics of the Ca²⁺ distribution.

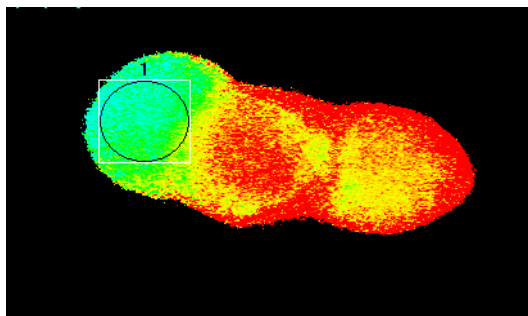
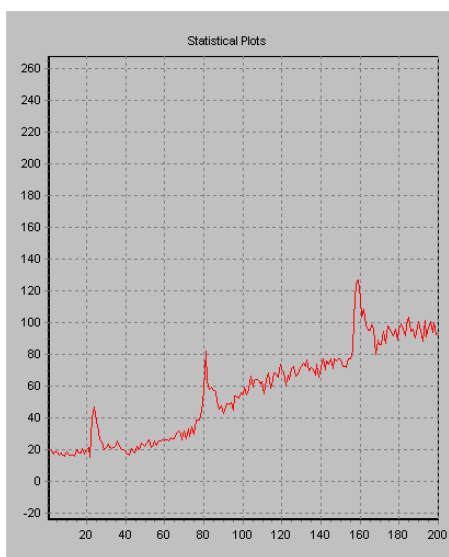
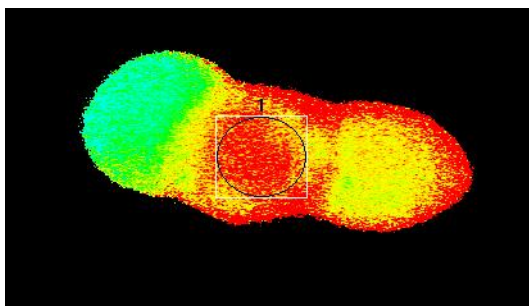
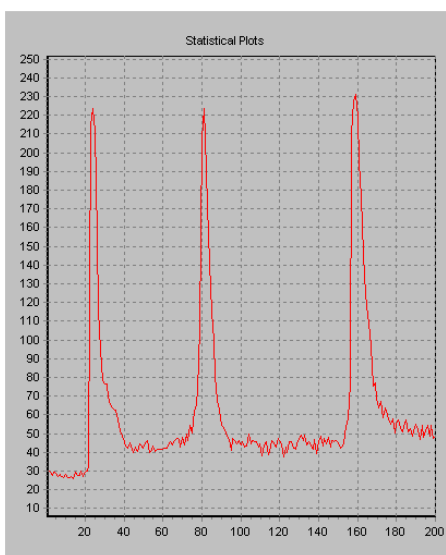
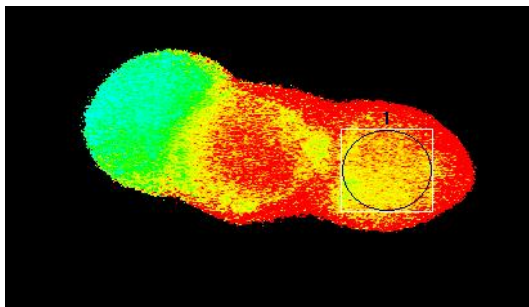

6.11.8 Comparison of two calibration methods

We now present data from the HEK cell example, showing the results of calcium ion concentration by the Grynkiewicz and Almers-Neher methods.

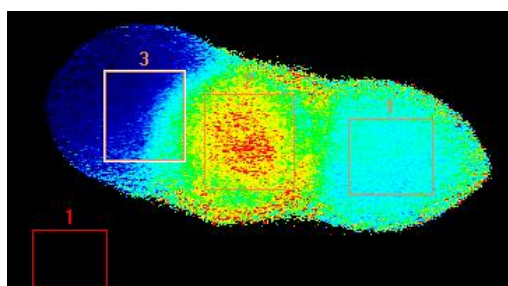

Figure 6.11.1 HEK cells were loaded with Fura 2 and imaged with a Hamamatsu 4880-80 cooled CCD camera, Kinetic Monokromator and Andor iQ. The cells were treated with acetylcholine in three pulses and responded with elevated calcium levels. Mean concentration data were obtained from the ROIs shown on the image. Courtesy Dr Paul Thomas, Department of Pharmacology, Cambridge University.

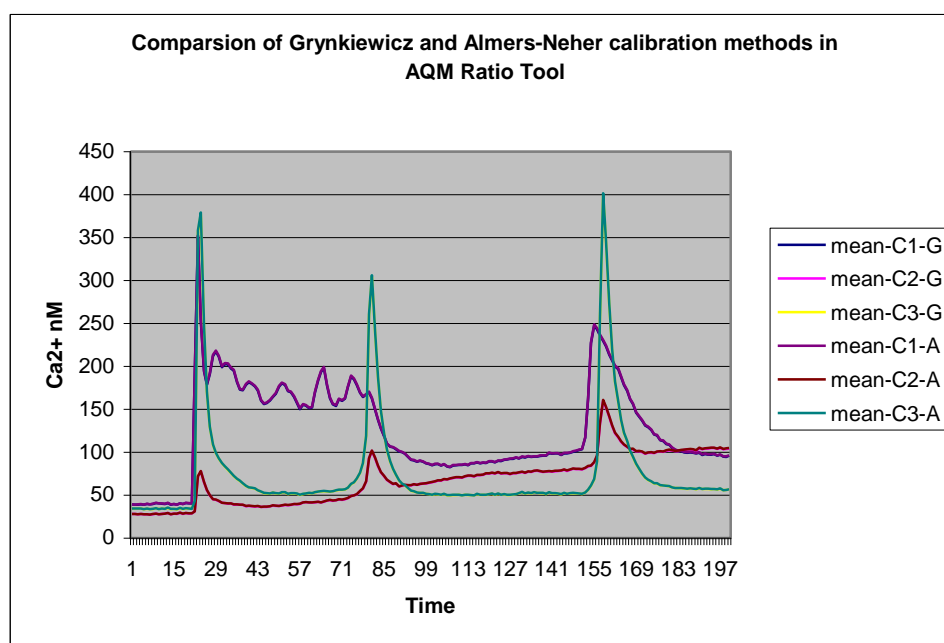

Figure 6.11.2 shows mean intensity vs. time in HEK three cells. Note heterogeneous response. The concentration data produced by the two calibration methods cannot be distinguished on the graph above. Tabulated data for 30 time points are shown in the table below.

Andor iQ USER GUIDE

mean-C1-G	mean-C2-G	mean-C3-G	mean-C1-A	mean-C2-A	mean-C3-A
39.0372	27.8282	34.1461	39.234	27.9689	34.3191
38.7552	27.9387	34.0805	38.9485	28.0773	34.2483
38.9572	27.4591	34.1447	39.1502	27.5971	34.3167
39.2263	27.8933	34.3041	39.4218	28.0332	34.4778
38.7477	27.4831	33.5238	38.9421	27.6226	33.6957
39.6307	27.4859	33.9895	39.8273	27.6212	34.1576
39.0977	27.1118	33.455	39.2952	27.2462	33.6222
39.6248	27.685	33.6357	39.8265	27.8252	33.8056
40.6566	28.3887	34.6258	40.8607	28.5306	34.7968
40.1485	27.524	33.5718	40.3522	27.6613	33.7404
40.0178	27.9969	34.1665	40.2173	28.1338	34.3354
39.5892	28.2121	33.9673	39.7866	28.3521	34.1343
40.8451	29.1231	35.2416	41.0491	29.2715	35.4202
38.7934	27.4939	33.6023	38.9926	27.6316	33.7729
39.4562	28.3069	33.8227	39.6543	28.4485	33.9925
38.7657	28.1186	33.3381	38.9635	28.2625	33.5061
40.1197	29.5165	34.8588	40.3222	29.6638	35.0337
39.5347	28.0738	33.647	39.7385	28.2153	33.8171
40.6812	29.0011	34.5001	40.8833	29.1471	34.6741
40.372	28.501	34.2063	40.5756	28.6439	34.3783
40.2071	28.5905	33.9559	40.4086	28.7355	34.1275
189.6756	30.9373	43.1931	190.7208	31.0923	43.4127
350.1005	71.46	356.1057	352.2077	71.8353	358.2575
252.7381	77.4903	376.9319	254.1812	77.9009	379.2376
194.1308	65.0202	245.6351	195.2011	65.3585	247.0312
178.5373	55.7029	169.4519	179.5111	55.8906	170.374
190.5858	49.7103	129.3414	191.6335	49.9623	130.0298
212.0788	44.9895	108.3797	213.2619	45.2194	108.9489
217.1133	44.5086	98.8777	218.3241	44.7374	99.3896
211.0195	43.005	92.5054	212.1955	43.2229	92.9903

Table shows a comparison of Ca²⁺ concentration (30 time points) after calibration with Grynkiewicz et al and Almers-Neher calibration tools. Key: columns with -G for Grynkiewicz and -A for Almers-Neher.

6.12 Image-Image Math Plugin

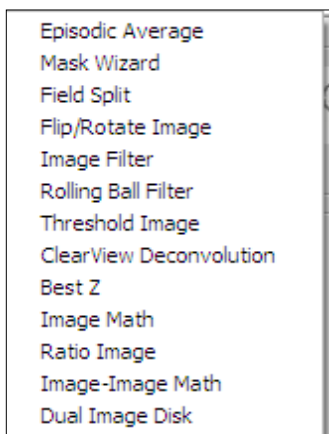

The Image-Image Math Process is accessed from the Process Menu on the Control Window. The process performs dyadic arithmetic operations between n-Dim images, which include addition, subtraction, multiplication and division between **two** source images to produce a destination image.

Selecting Math Image from the list opens the **Diadic Math:** Window as shown below.

The module provides several processing modes to be selected, depending on the details of the Source Images. These options are listed at the bottom of the dialog and are explained in more detail below.

The user can Load and/or Save Settings by selecting **File** on the Menu Bar. Select **About** to view product information.

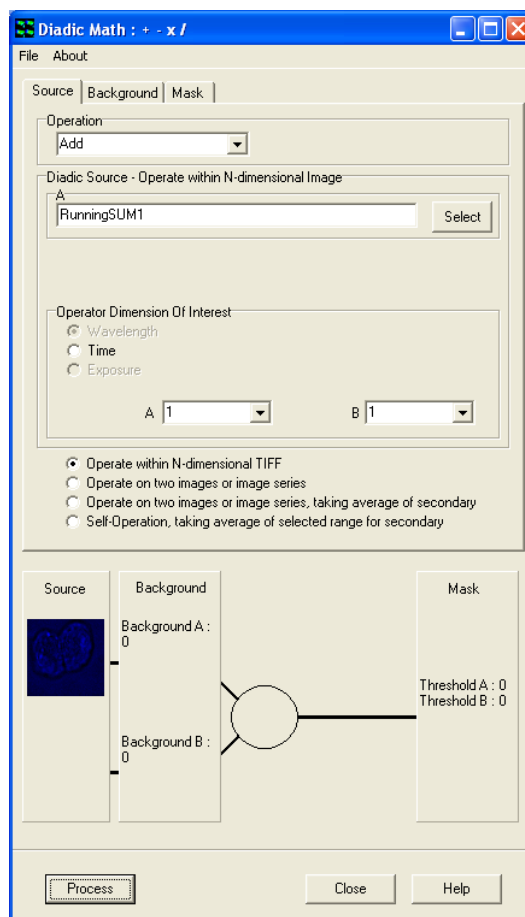

6.12.1 The Source Tab

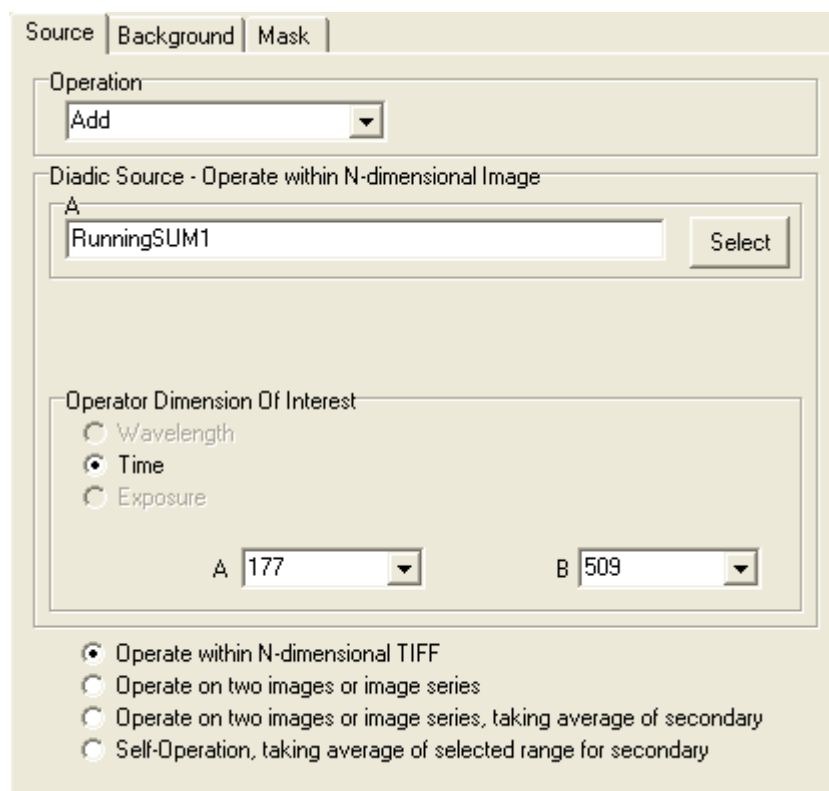

6.12.1.1 Operation

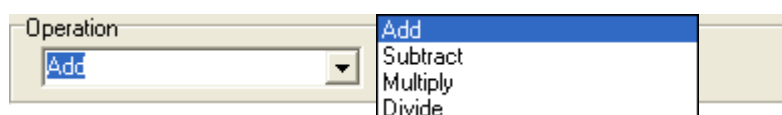

Select the Operation from the dropdown list.

Add – This is used to produce a resultant image, whose pixel intensity at any coordinate is equal to the pixel intensities of two input images added together, at the corresponding coordinates.

Subtract – This is used to produce a resultant image, whose pixel intensity at any coordinate is equal to the pixel intensities of one input image subtracted from the pixel intensity of another, at the corresponding coordinates.

Multiply – This button is used to produce a resultant image, whose pixel intensity at any coordinate is equal to the pixel intensities of two input images multiplied together, at the corresponding coordinates. The result will be a floating point image, where pixel values are not scaled, but represent the real product.

Divide – This button is used to produce a resultant image, whose pixel intensity at any coordinate is equal to the pixel intensities of one input image divided by the pixel intensities of a second input image, at the corresponding coordinates. The result will be a floating point image, where pixel values are not scaled, but represent the real quotient of the two Source images.

6.12.1.2 Diadic Source – Operate with an N-dimensional Image

The values under the Source tab will change depending on which radial button is selected.

- 
- Operate within N-dimensional TIFF
 - Operate on two images or image series
 - Operate on two images or image series, taking average of secondary
 - Self-Operation, taking average of selected range for secondary

If Operate within N-dimensional TIFF is selected:

Select an image to use. This will default to the image currently in the

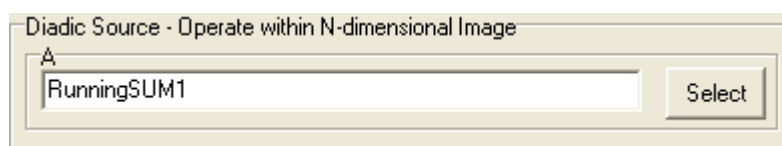
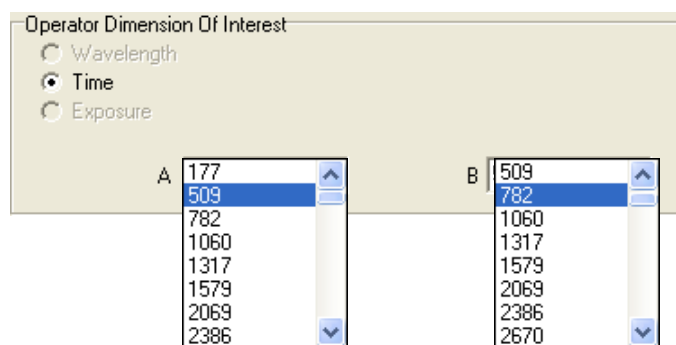

Image Window. Press the Select button to choose a different image. This will open the Image Selection Window. Double click an image from the image list to select.

Andor iQ USER GUIDE

If Time is selected, select a value from each dropdown list.



If Operate on two images or image series is selected:

Select which **Operation** to use from the dropdown menu.

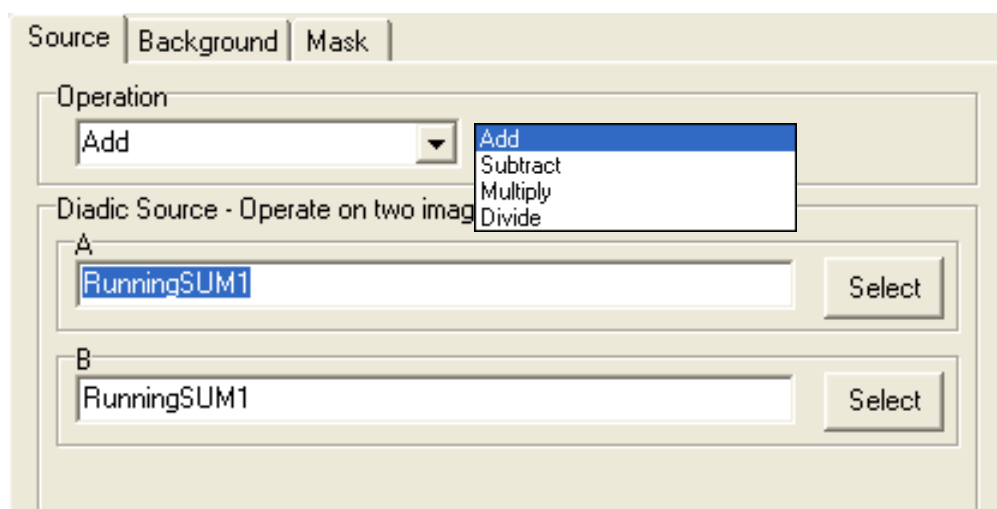

Select each image by pressing the **Select** button for both A and B and choosing from the image list.

If Operate on two images or image series, taking average of secondary is selected:

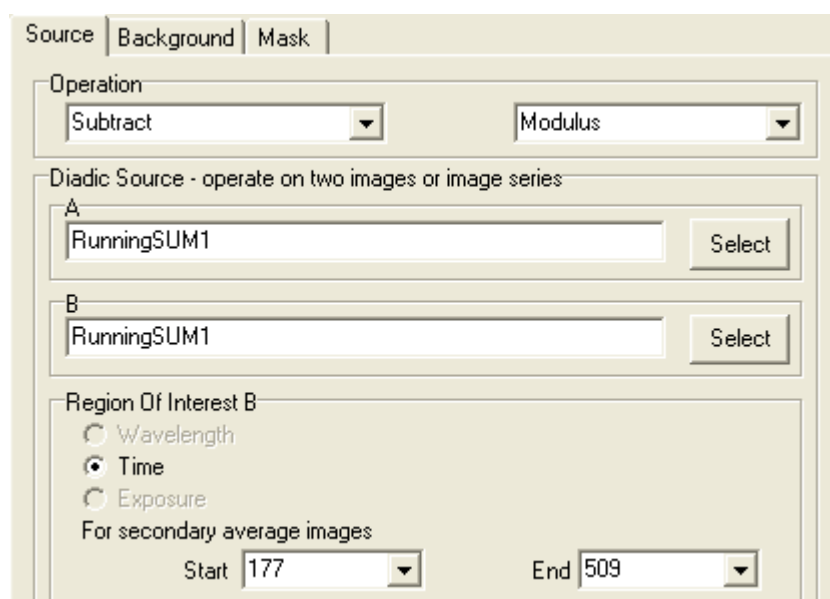

Operation

Select the Operation from the dropdown list as follows.

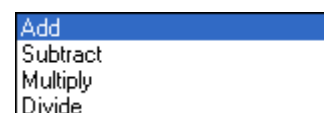

If Subtract is selected (as above picture shows) from the dropdown list an additional box will appear giving the user the following options.

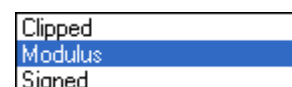

If subtract is not selected no other selections will be necessary.

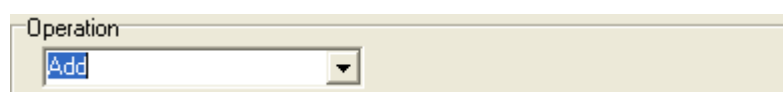

Diadic Source – operate on two images or image series

Use the Select button to select an image from the image list for both A and B.

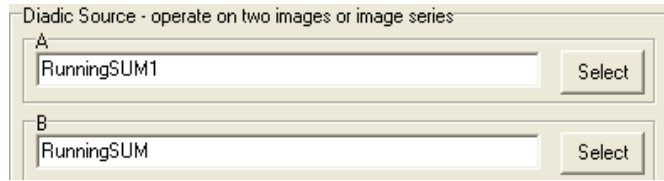

Region of Interest B

When **Time** is selected, use the dropdown menu to select a **Start** and **End** Value.

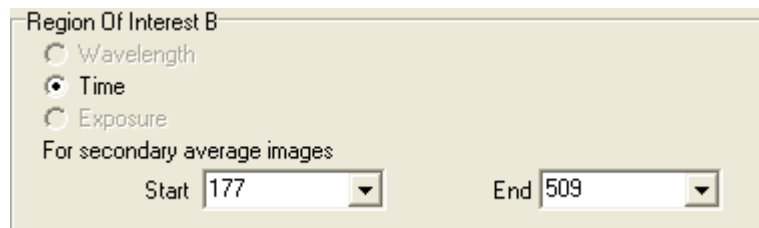

If Self-Operation, taking average of selected range for secondary is selected:

Operation

Select the Operation from the dropdown list as follows.



If Subtract is selected (as above picture shows) from the dropdown list an additional box will appear giving the user the following options.



If subtract is not selected no other selections will be necessary.

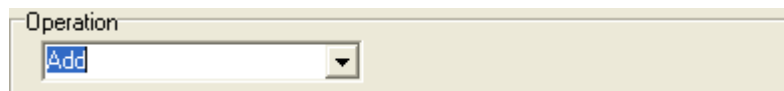

Diadic Source – Self Operate

Use the **Select** button to select an image from the image list.

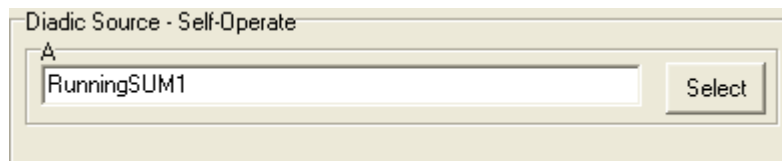

Region of Interest B

When **Time** is selected, use the dropdown menu to select a **Start** and **End** Value.

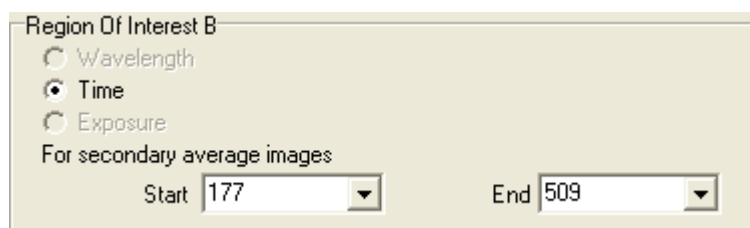

6.12.2 The Background Tab

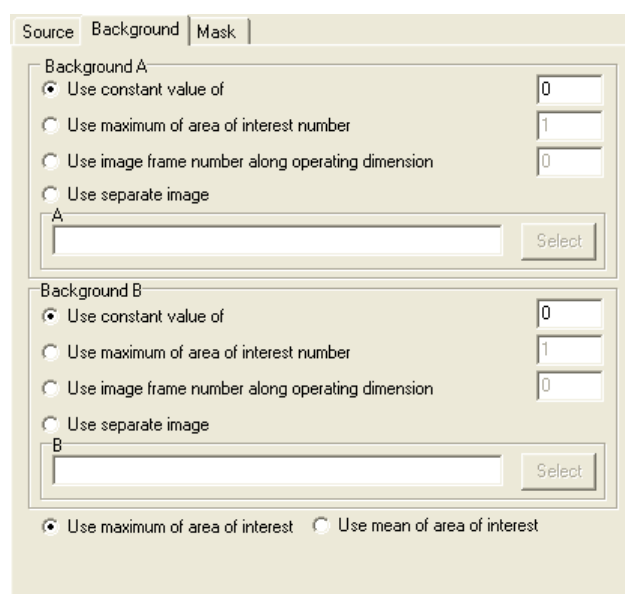

Background A/Background B

This tab is used to specify the Background Correction Values which will operate before the primary mathematical processing is started, Background correction will subtract the value specified in the selection from each pixel in each image prior to the calculation. Options included are:

A constant value can be specified.

Maximum or Mean of a numbered Region of interest.

One frame from the Source Image(s) A/B.

A separate image in the image list can be used.

Select one of the options and type a value into the text box for both A and B if applicable. If Use separate image is selected use the select button to choose an image from the image list.

6.12.3 The Mask Tab

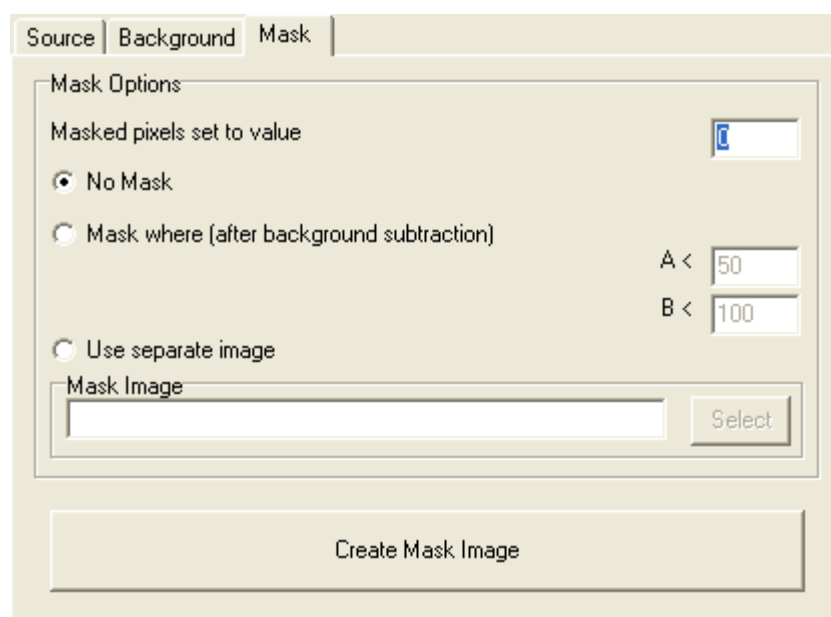

A Mask defines the region over which the processing will be executed. It is a binary result of a pixel by pixel comparison against a constant value (Mask where...) or it is a binary image or image series. Whenever the result or image is "1" the calculation will be executed, otherwise the pixel in the Destination image will be set to "Zero". This ensures that processing will be constrained to regions of the image where there is useful information and not background noise.

Select **No Mask** if a mask is not being used.

Select **Mask where (after background subtraction)** if you know the values you want to use.

Select **Use separate image** if you would like to create a mask with another image. Use the select button to select another image from the image list.

Select the **Create Mask Image** to create a mask. This will launch the Mask Wizard (**Section 6.1.2**).

6.12.4 Processing Summary

Each option selected under the Source, Background and Mask Tab will be previewed at the bottom of the (Math Plug-In) Window as shown below.

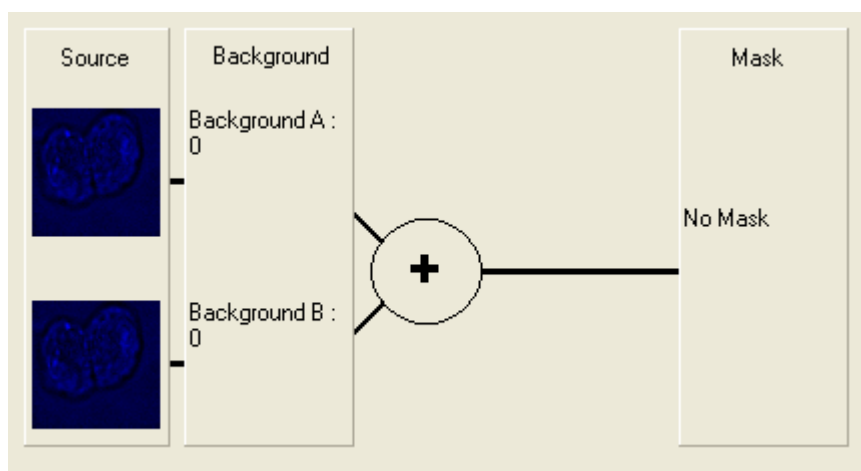

Under Source, there will be a preview picture for each image chosen. However, if Operation with N-dimensional TIFF or Self Operation, taking average of selected range for secondary is selected there will only be one image present under Source. Background will preview the selections chosen under the Background tab for both Background A and Background B. The selected Operation (e.g. Addition) will show in the circle. The Threshold values for the Mask for both A and B will show under Math if a mask is selected.

Close

Press the close button to exit the Plug-In.

Help

Press the Help button to access section reference for User Guide.

Process

Once all selections have been made under each tab, press the **Process** button. A new window will open as shown on the right. If **Display Current Image Slice** is selected a live preview will show in the window. Press **Cancel** at any time to exit setup. The new image will then be added to the image list.

Once the processing is complete the new Destination Image will appear in the ImageList from where they can be shown and selected for other processing.

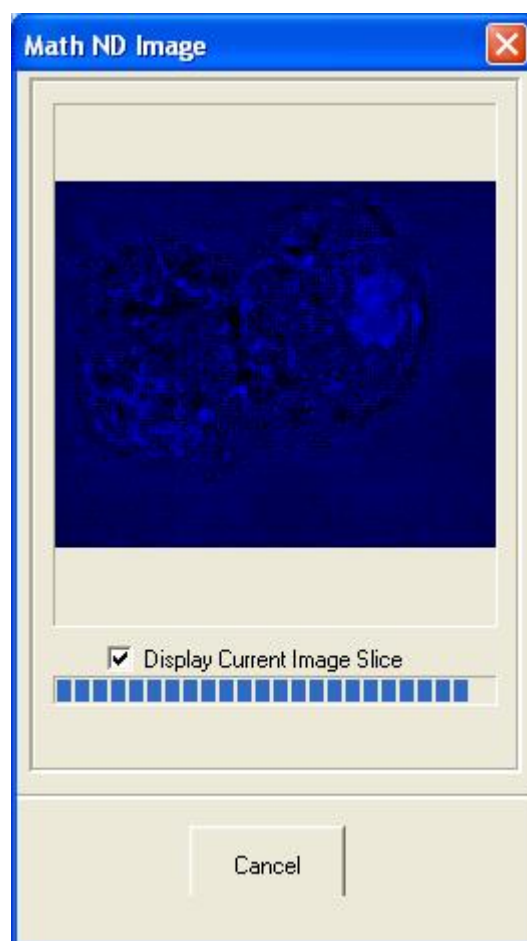

6.13 Dual ImageDisk Plugin

The Dual Image Disk plugin is found in the Process menu in iQ’s Main Window. It is primarily designed to combine images from two separate Image Disks. For example, a dual camera system incorporating two identical cameras running under 2 instances on of iQ on a single PC capturing data from two wavelengths or two imaging axes simultaneously. Simultaneous capture can also be supported under two separate PCs, each with its own ImageDisk. The Dual Image Disk plugin can see the data on one or more Image Disks and combine them into a single dataset, including alignment adjustments (rotation and translation).

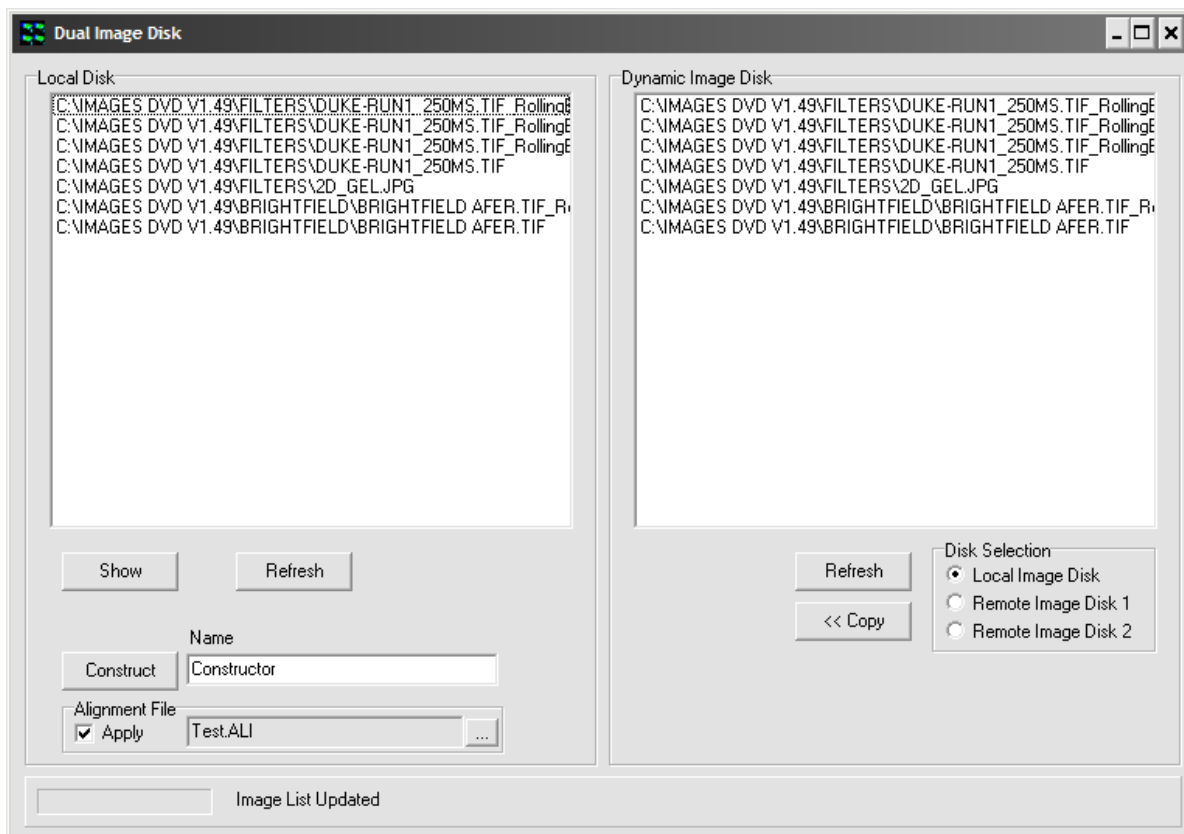

Just like the ImageDisk itself, the location of any other Image Disk(s) must be configured in the Global Configuration Settings using the Configuration Manager. If two PCs are used, then they must be connected via a Microsoft Network and the Master PC will have the Slave ImageDisk (disk drive) “Mapped” in Windows Explorer, and hence assigned a drive letter e.g. Z: or K: See the chapter 2 for more

details about the setup of the dual ImageDisk.

If both instances of iQ are on the same PC they will acquire to the “Local ImageDisk” as shown here.

Once opened, the Dual Image Disk plugin can be seen as above. On the left are the contents of the local Image Disk. Clicking an image in the list and pressing “Show” will load the selected image into iQ’s Image Window. Pressing “Refresh” will update the list. On the right, it is possible to see one other Image Disk. Selecting the appropriate option from the “Disk Selection” region will update the list. Any image can be copied from the Image Disk shown on the right to the Local Disk by pressing the “<< Copy” button, although this step is not necessary to combine images.

Combining two images together is simply a matter of selecting one image from each Image Disk and pressing the “Construct” button. This will copy the selected image from the Remote Image Disk to the Local Disk and combine them in one operation. The name of the new image can be defined in the “Name” textbox. The new image will appear in the Local Disk and can be loaded into the Image Window by selecting it and pressing “Show”.

Note that images to be combined must be identical in all dimensions – e.g. it is not possible to combine one image that is 1000 x 1000 pixels with one that is 512 x 512 pixels, nor is it possible to combine one image with 100 time points with another that has 101 time points, even if the resolution is the same in both images.

Finally, it is possible to perform an alignment during the construction process. To create the alignment file, first run the Field Split plugin (see Section 6.3) and save an alignment file. To enable alignment during construction, check the “Apply” checkbox in the “Alignment File” section of the Dual Image Disk window and open the appropriate file by pressing the “...” button to the right.

6.14 Plug-In Registration and Access

The Plug-Ins are accessed from the Andor iQ **Plug-Ins** menu as shown below.



Plug-In modules provided with Andor iQ are automatically registered during start up of the program and are ready for use. The **RGB Merge** and **Photobleaching Compensation** functions are not dynamically loaded and appear automatically on the Plug-Ins menu each time Andor iQ is executed. Modules, currently under development will be available for purchase in the future and can be registered using the Configuration Manager. The use of the Configuration Manager is discussed in **Appendix 2**. Instructions regarding the installation of any subsequent Plug In modules will be provided at the time of purchase.

Selecting the Plug-Ins menu item allows any of the activated functions to be selected from the list.

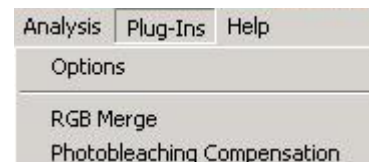

6.14.1 Options

Clicking on the **Options** menu item enables the appropriate Plug-In function to be activated by enabling the associated check box as shown in the example.

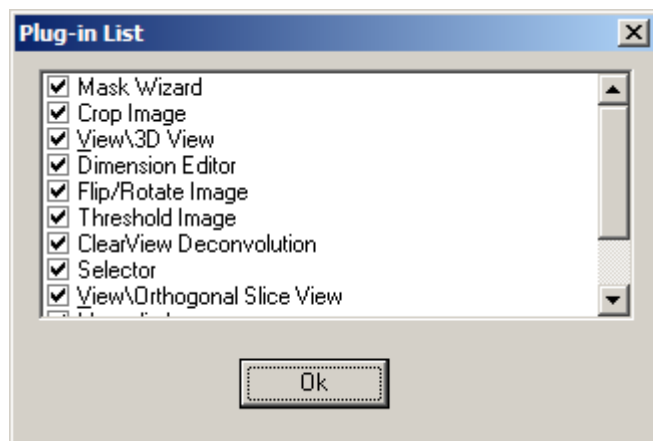

6.15 RGB Merge

This is used to merge multiple images and/or multi-dimensions (e.g. Z, T, Field), selected from the Image Disk. The merged image will be displayed in the Image Window, having pixel intensities equal to the pixel intensity of the first image plus the pixel intensity of each subsequent image at the corresponding coordinates.

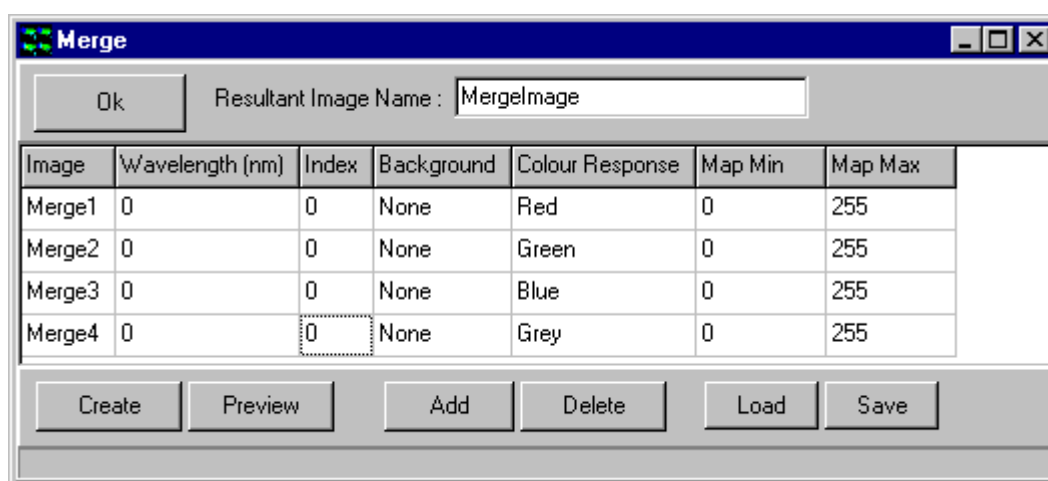

Press **OK** to close the Merge dialogue. The current settings will be remembered the next time that RGB Merge is selected from the Process Menu.

On completion of the Merge, the resultant image is added to the Image Manager. It is assigned the name typed into the **Resultant Image Name** text box.

The **Image** column is used to select the images to include in the merge.

To select an image, click on a cell in the column. A dropdown list will display all the images currently in the Image List, from which you should select the required image.

Note: All images must be the same size along each dimension.

The merged image will be displayed in the Image Window, having pixel intensities equal to the pixel intensity of the first image plus the pixel intensity of each subsequent image at the corresponding coordinates.

The second column in the table is used to specify which frames to include in the merge. In this example, only the frames that have been acquired at wavelength zero

will be included.

The **Index** column is used by the software and does not require any user input.

There are three possible options for the **Background** parameter:

ROI - If a region of interest is defined on the image using one of the region defining tools in the Image Toolbar, the average intensity of the region will be taken as the background intensity of the ratioed image.

Image- A dropdown displays all images from the Image List. Select an image; the background intensity of the merged image will be set to the average intensity of the selected image.

None - The background intensity will be set to zero.

Each node should be assigned a **Colour Response**, grey for a grey image, or a red, green or blue component.

Note: Although you can include as many Images as you like in the Merge, there are only four colors available to which they can be assigned.

The minimum and maximum values of the mapping or image contrast should be specified in the **Map Min** and **Max Map**. This modifies the display of image pixel intensities in the Image Window, and is used to improve the contrast of the image or to view specific image properties. Only the Image Window display is changed, the underlying image pixel intensities remain the same. For Multi-dimension images, each image can be seen and mapped independently. There is also a provision for XY jog or shift to allow precise alignment corrections.

The maximum value can be up to 2^n-1 for an n-bit image.

e.g. for an 8-bit image the highest possible threshold value is 255. For a 12-bit image the highest possible threshold value is 4095.

After specifying the criteria for the merged image, press **Create** to start the Merge. The Create button will change to **Stop**, press this at any time to abort the Merge.

The merged image will be displayed in the Image Window, having pixel intensities equal to the pixel intensity of the first image plus the pixel intensity of each

subsequent image at the corresponding coordinates.

The **Preview** button is used to display a preview of the merged image.

The **Add** button is used to add an additional image to the list, for inclusion in the Merge.

The **Delete** button removes the selected image from the list. The selected row will be deleted from the table.

The **Save** button opens a standard Windows Save File dialogue, with which you can save the current Merge setup. This can then be loaded for future use with the **Load** button.

On pressing **Create** the selected images are merged and the progress of the merge is displayed in the progress bar at the bottom of the dialogue.

6.16 Photo-bleach Compensation

In time-lapse imaging, a fluorescence sample (often live cells) will commonly become less intense with time due to several factors, including photo-bleaching. This can be reduced by minimizing the sample's exposure to the excitation light source. Andor iQ ensures that the sample is exposed for a minimum time period by ensuring the shutter opens and closes as closely as possible with the camera exposure commands. However, there may still be significant fading that must be addressed. This is necessary for visualization, where fading is a nuisance and also in quantification, where fading represents a decreasing baseline upon which fluctuations must be observed.

Photo-bleaching compensation can be achieved using two different methods:

- 1) Normalization baseline adjustment - normalize the image sequence by ratio with a known unchanging area.
- 2) Depending on the sample and whether the fluctuations are localized it may be possible to use the entire image intensity as the baseline with which to normalize.

A background correction can also be applied to the data. Following the calculation of a mean intensity, pixels with intensities less than or equal to the background level can be ignored or set to zero during the photo-bleaching compensation calculation.

Problems may arise when the objects in the sample are moving and the ROI is not a valid fading reference.

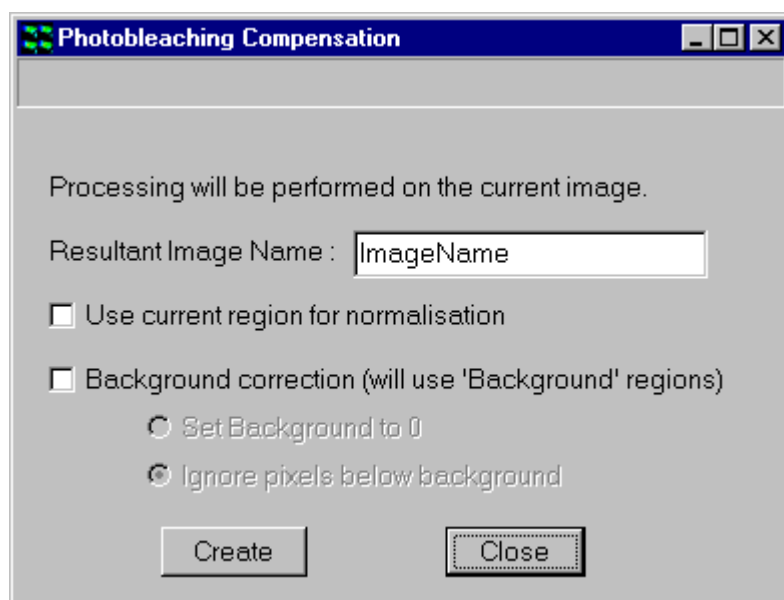

Select **Photo-bleaching Compensation** from the **Process Menu**.

Type the name you wish to give the resultant image into the text box (default is ImageName).

The resultant image will be displayed in the Image

Window and added to the Image List.

If **Use current region for normalization** is selected, you should define a region about an unchanging area on the image, using the ROI tools in the Image Toolbar. The mean pixel intensity of the ROI is calculated for each frame of the image, and the intensity of each pixel in that frame in the image divided by that value.

Depending on the sample and whether the fluctuations are localized it may be possible to use the entire image intensity as the baseline with which to normalize. In this case ensure that **Use current region for normalization** is deselected. The mean pixel intensity of the entire image plane is calculated and the intensity of each pixel in that frame divided by that value.

If the data needs to be background corrected, a Background ROI(s) should be defined using the ROI tools and the check box enabled for the **Background Correction (will use 'Background regions)** option. A background intensity corresponding to the mean pixel brightness of the ROI is calculated for each frame of the image and pixels with intensities less than or equal to the background intensity can be set to zero or ignored during the subsequent calculation.

The choice of the particular correction method to be applied is made by selecting the appropriate radio buttons, **Set Background to 0** or **Ignore pixels below background**.

The benefits of the Photobleaching Compensation algorithm are illustrated below.

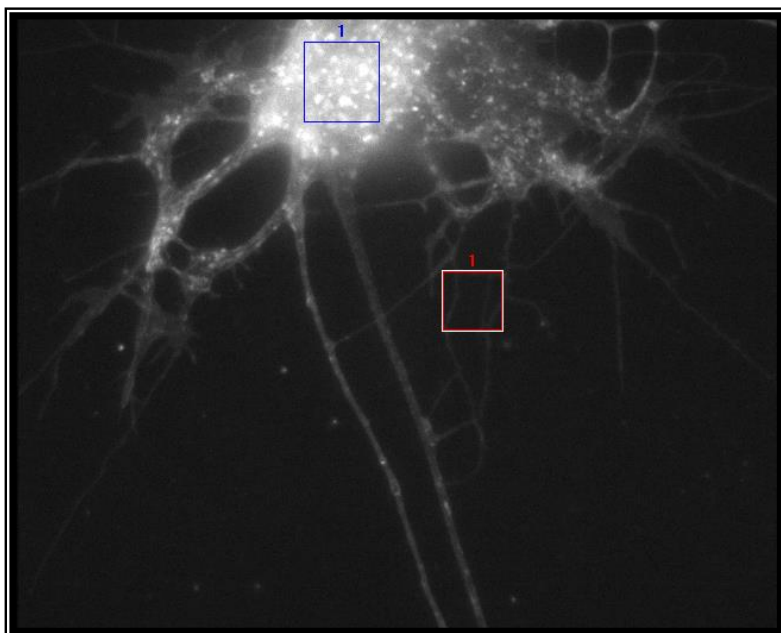

Source Image

User defined ROI

Background ROI

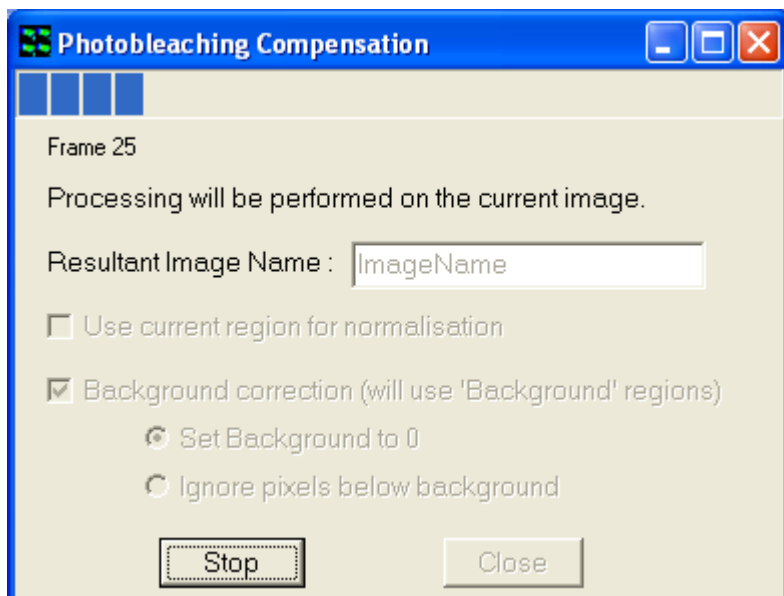

Definition of compensation parameters

Results of Through-Series Analysis within the user-defined ROI

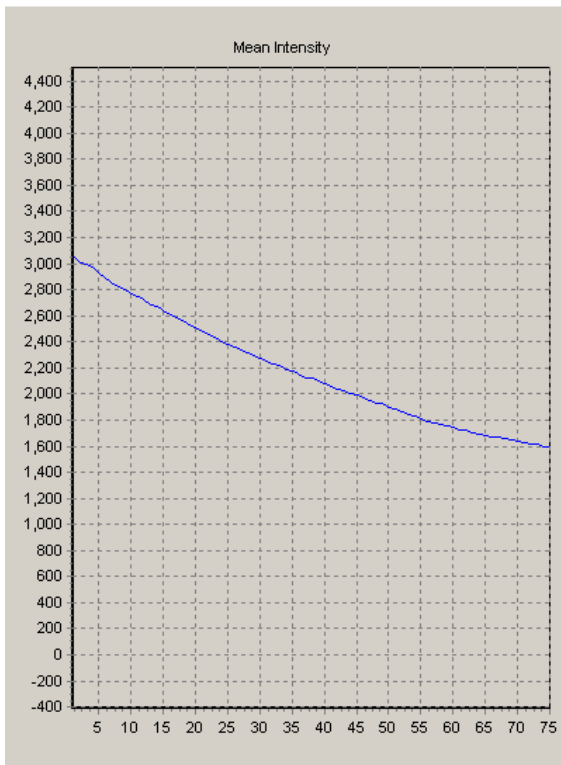

Prior to Compensation

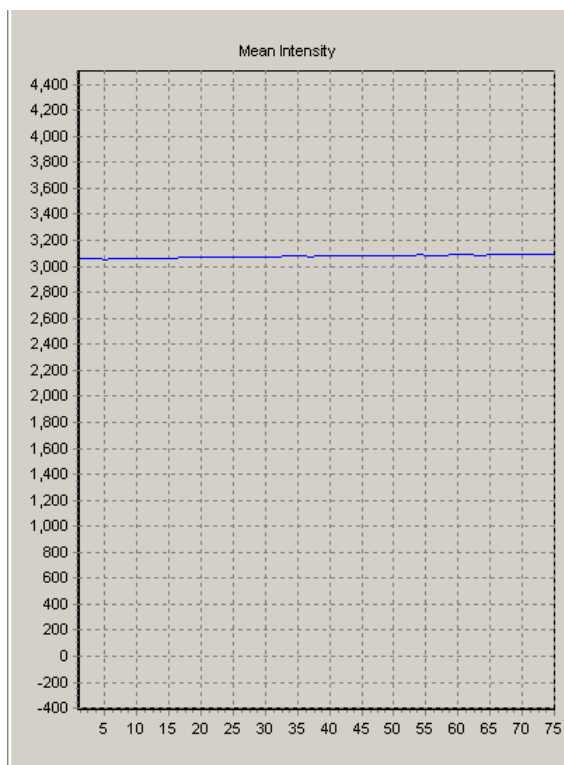

After Compensation



Appendix 1 - Installing the Software

A1.1 Installation of Sentinel Drivers

If you are running Windows NT or above you will need to install Sentinel drivers, which are required for your Software Protection Key (Dongle), without which your Andor software will only run in Demo Mode.

Note: It is not necessary to install Sentinel drivers if running in Windows 95 or 98.

Demo mode has all the functionality of the full version of the software except:

You cannot acquire images.

You can only open Demo images from your Andor Installation CD-Rom.

You cannot save data.

To install the Sentinel drivers, insert the CD into the CD-Rom drive, then run the program **START.EXE**, which is in the root directory of the CD. This will start the Installation Program, from which you should open the **Software Protection** page and select the option:

Install Dongle Drivers

This will open the Rainbow Technologies Sentinel installation:

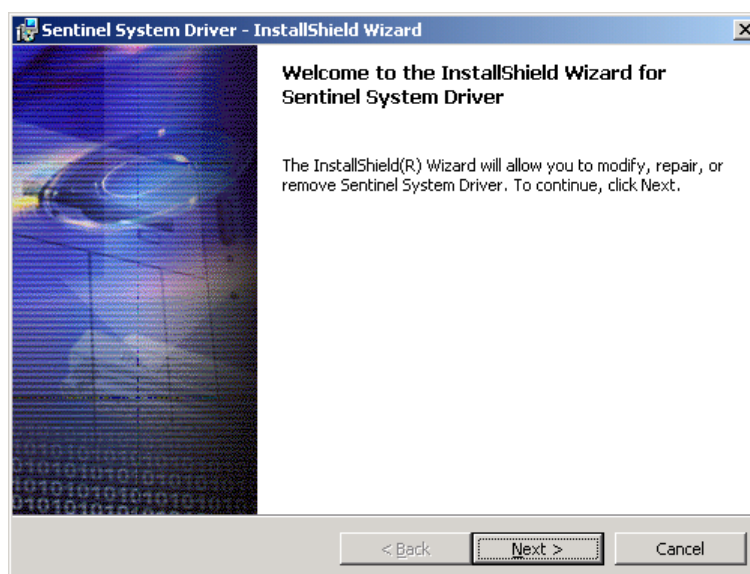

Accept the terms and conditions of the license agreement.

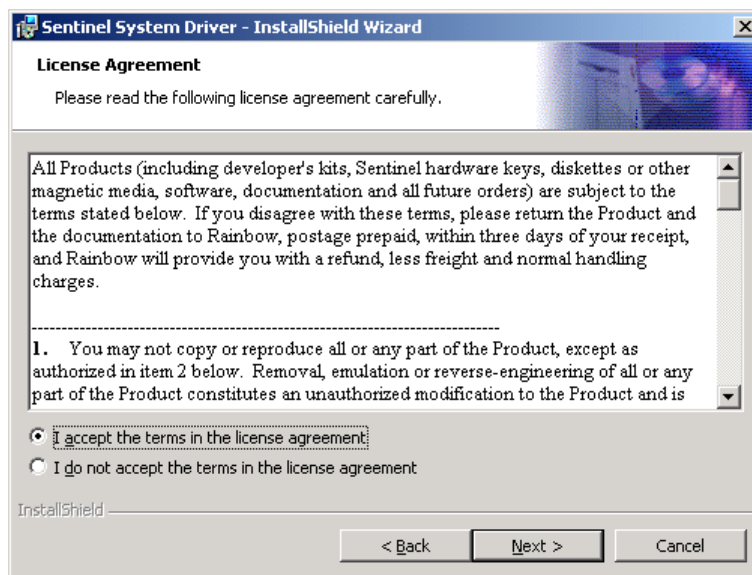

Select the **Custom** installation option.

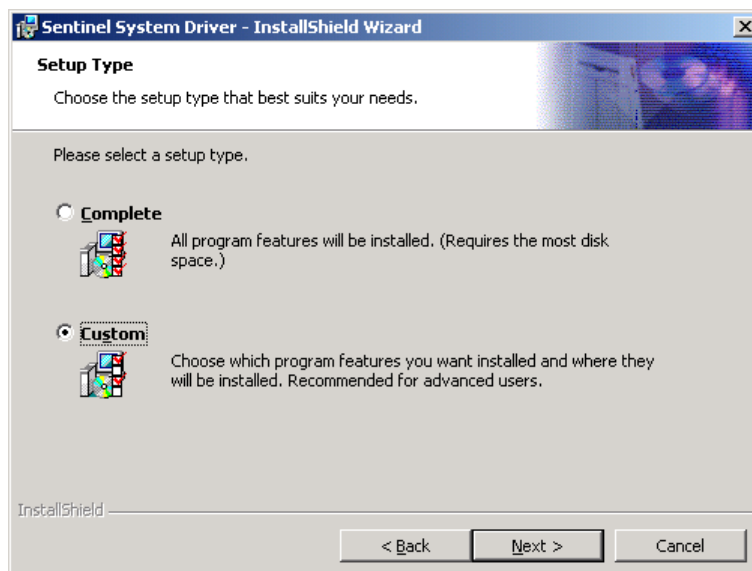

Disable the USB Support (Not available for users in NT)

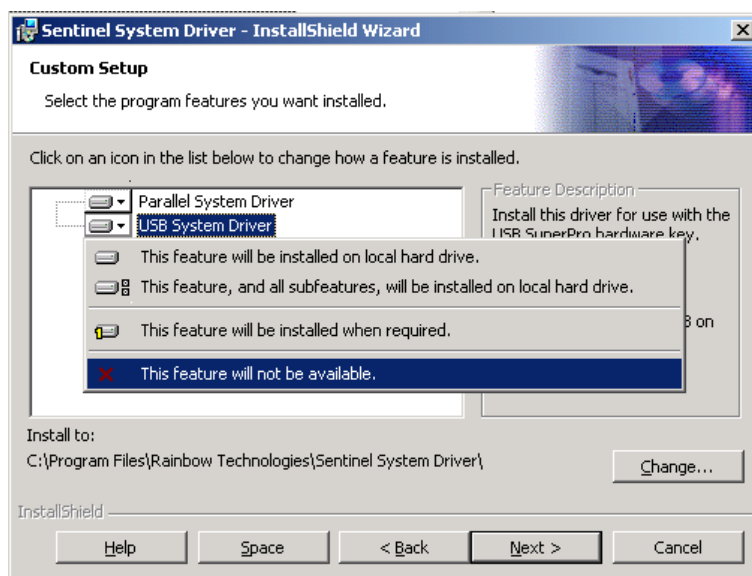

Continue with the installation.

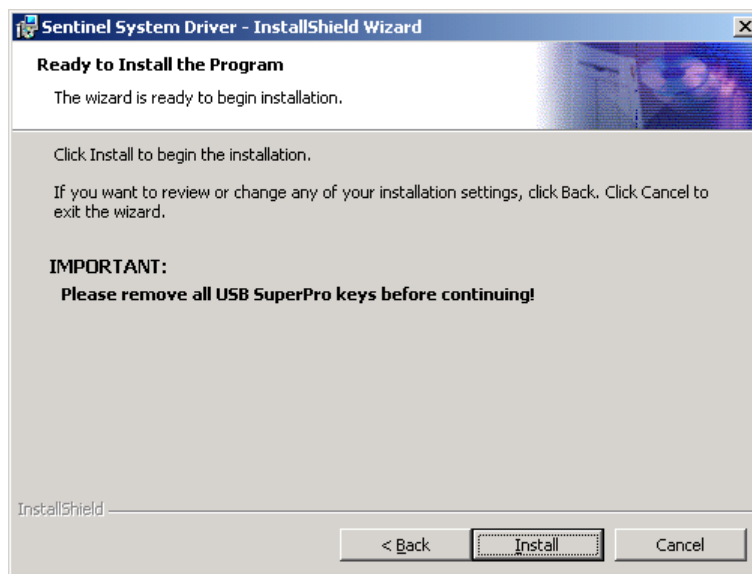

The Sentinel Driver installation will complete, Windows NT users may have to re-boot their PC after driver installation.

A1.2 Troubleshooting Dongle Issues

If the Andor Software runs in Demo mode, even after plugging the dongle onto the parallel (or USB) port and installing the Sentinel Drivers (described above), there are a number of things to check:

The drivers are installed correctly:

Start -> Settings -> Control Panel -> Add/Remove Programs

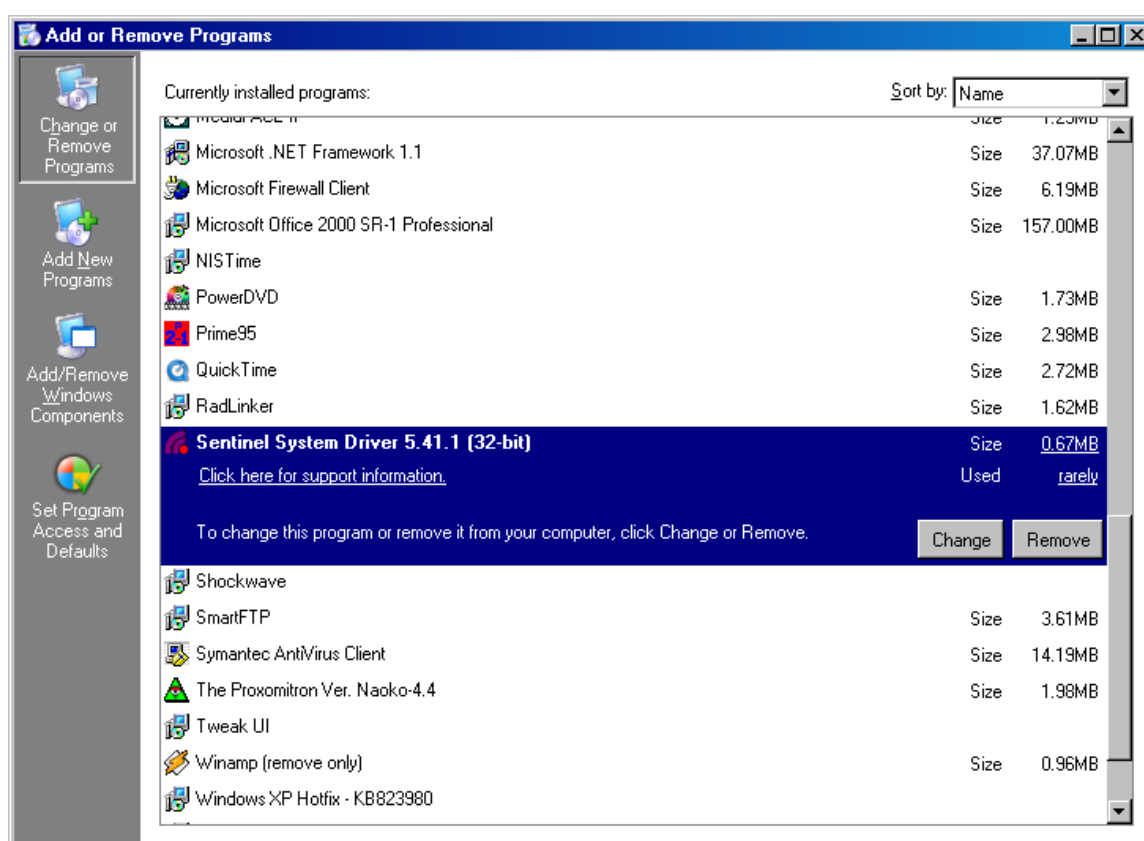

Ensure that the Sentinel System Driver is listed. If it is not, repeat the installation process described previously.

There are no other devices connected to the parallel port:

Sometimes, having a printer (or other device e.g. another dongle) attached to the dongle can cause problems.

There is no other software which may interfere with the parallel port:

Similar to having a device connected.

The parallel port is enabled correctly in Device Manager and the BIOS:

Right click 'My Computer' on the Desktop -> Properties -> Hardware -> Device Manager.

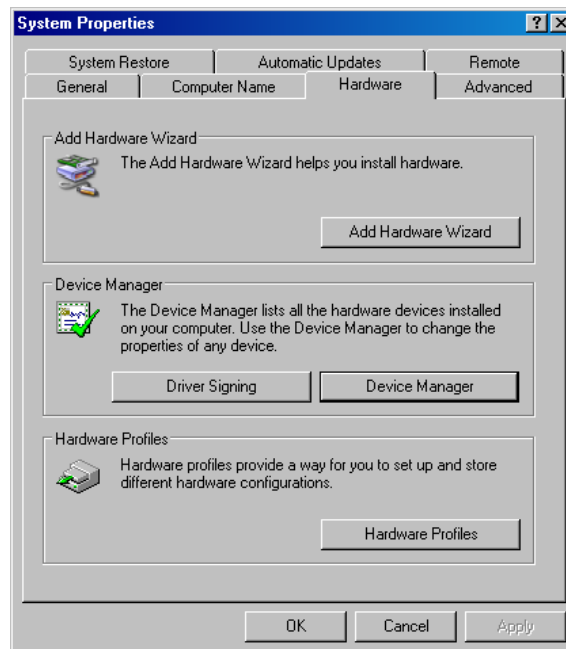

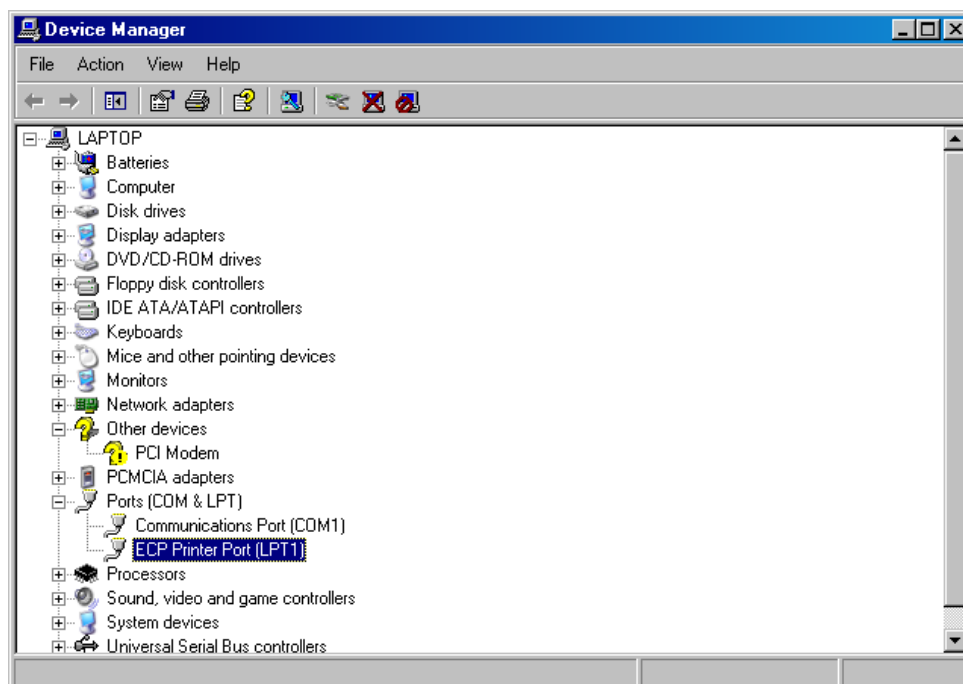

The Parallel port should appear as ECP or EPP in Device Manager. If it does not appear, or is listed as SPP, restart the PC and change the parallel port settings in the BIOS. If you are not happy with this step, contact IT support or a computer-competent person.

A1.3 Initialising a Dongle for Additional Products

If you have purchased an Andor Product (and Dongle), and now wish to install and run another, the Dongle will need to be updated to allow the new software to run. This is performed within **Configuration Manager (Section 2.3.1 and Appendix 2)**.

When an additional product is purchased (Andor ClearView for example), a dongle initialisation code will be supplied.

Run the **Configuration Manager** from **Start -> Programs -> Andor Bio-imaging**;
Click the **Settings** menu item and select **Software Protection Key**;
Input the initialisation code, including hyphens, into the blank space (to the right of the **Initialise Dongle** Button);

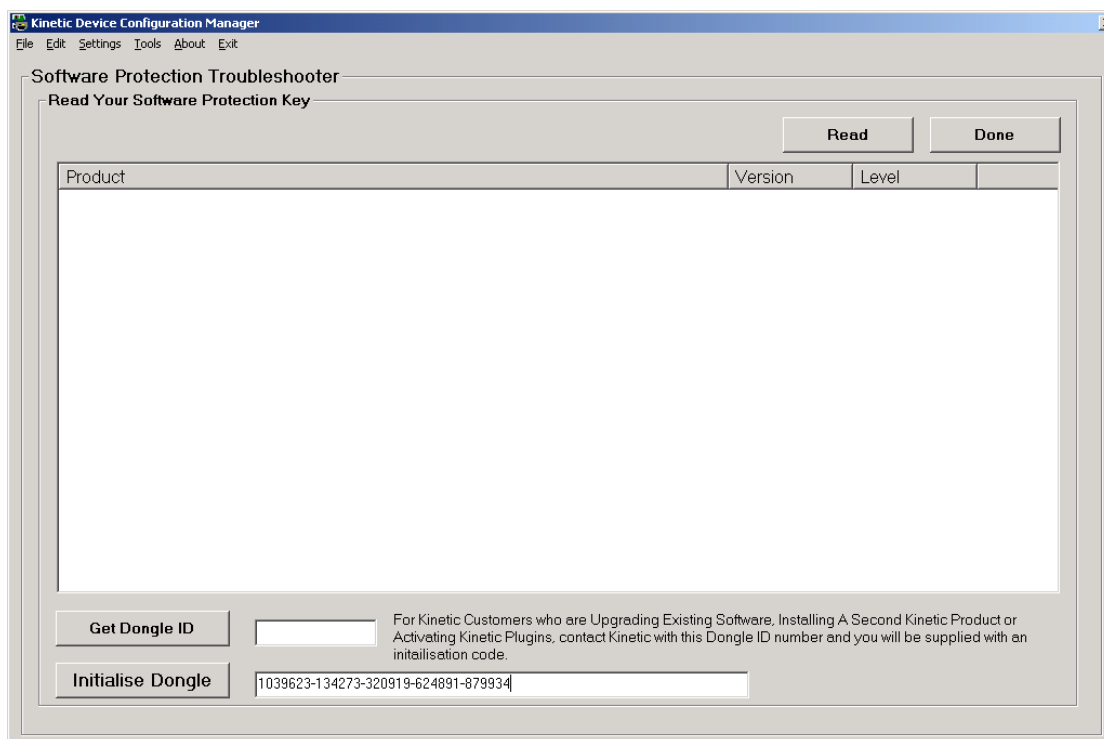

Press the **Initialise Dongle** Button.

Exit Andor Configuration Manager.

A1.4 Install the Latest Windows NT Service Pack

If running under Windows NT we recommend installing the latest Windows Service Pack, which is included on the Andor Installation CD-Rom.

1) If the installation program is not already running, insert your Andor Installation CD-Rom into your CD-Rom drive and run the program **Start.exe**, which is in the root directory of the CD. This will start the installation program, which runs side-by-side with an installation Online Help Guide.

2) Select the **Help and Utilities** page and click on the text:

Install Windows NT Service Pack

3) Follow the on-screen prompts, accepting the default values. The Service Pack will be installed on your system, after which you will need to reboot your computer.

Note: You can also install the Windows NT Service Pack from you CD-Rom without starting the installation program. From the **I386 \ Update** folder on the CD-Rom run the program **update.exe** and follow the on-screen instructions.

A1.5 Installing the Windows Scripting Host

If you are running under Windows NT and are using the Andor Image Disk, you will need to install the Windows Scripting Host to use the Image Disk Configurator.

1) If the installation program is not already running, insert your Andor Installation CD-Rom into your CD-Rom drive and run the program **Start.exe**, which is in the root directory of the CD. This will start the installation program, which runs side-by-side with an installation Online Help Guide.

2) Select the **Help and Utilities** page and click on the text:

Windows Scripting Host

3) Follow the on-screen prompts, accepting the default values. The Windows Scripting Host will be installed on your system, after which you will need to reboot your computer.

Note: You can also install the Windows Scripting Host from the CD-Rom without starting the installation program. Run the program **ste51en.exe** from the **Wsh** folder on the Andor Installation CD-Rom.

A1.6 Installing your Andor Software

1) If the installation program is not already running, insert your Andor Installation CD-Rom into your CD-Rom drive and run the program **Start.exe**, which is in the root directory of the CD. This will start the installation program, which runs side-by-side with an installation Online Help Guide.

2) Select the **Andor Software** page and click on the software that you wish to install, following the on-screen prompts

The installation creates a program group called **Andor Bio-imaging** and program icons are added to this group. To run a program, simply double click on the appropriate icon.

3) If you are installing an **upgrade product, uninstall the previous version first.** Use the Control Panel Uninstall feature. Your Protocols, Channels and Scans should remain valid and in tact.



Appendix 2 - Configuration Manager

A2.1 The Configuration Manager

A2.1.1 Global Configuration Settings

When Configuration Manager is first run, there will be no Configurations and you will first be invited to setup the **Global Settings**. These allow you to select parameters that will affect User Access level control and ImageDisk configuration.



Multi-User Access ON - the controls will be applied to Users according to the local machine status decided by the Administrator. If you have **Multi-User Access OFF** - all users have Full access. This option is set by clicking on the appropriate checkbox in the Configuration dialog shown over.

The ImageDisk Configuration is accessed by selecting **Global Configuration Settings** item from the Settings Menu.

As previously mentioned, all Andor Bio-imaging applications use a folder to store acquired image data in a RAW format. The Configuration Manager specifies the drive where this folder will be located. For best performance, we recommend a separate fast SATA, SCSI or EIDE drive, or even a RAID array, for this purpose, but

only the Administrator can specify the drive. However, it must be accessible for full rights by ALL users when running Andor iQ, otherwise restricted access users will have access only to the Windows virtual memory system, the contents of which is lost whenever iQ closes down.

Image Disk Path - The path to the Image Disk folder is configured here when the drive is selected in the drop down box. The free disk space of the partition selected is displayed to help select an appropriate place for this folder.

Note: We strongly recommend NOT using the System Partition for ImageDisk as this can cause system operation problems when full.

A Virtual ImageDisk can be selected which will force Andor iQ to use Windows Virtual Memory System to store images. Using the Virtual Memory system will mean that ALL images on the ImageDisk are lost at power down. In contrast images stored on a “Real” Disk Folder will be retained between sessions of iQ unless deleted by the users.

Private ImageDisk - The ImageDisk folder will be created on the specified drive. Each Windows Logon User will have a folder for their own images, thereby ensuring isolation between different users.

Shared ImageDisk - The ImageDisk folder will be created on the specified drive and then All Windows Logon Users will access a shared folder, thus allowing all iQ users to share images.

Images in RAM - specifies the number of frames that Andor iQ will attempt to keep in RAM at any one time.

Some image processing and visualization operations (e.g. 3D View, ClearView, Kymograph, RGB Merge & Orthogonal View) may require all frames to be loaded simultaneously, therefore this setting must exceed the total number of frames being

loaded. The Default Value is setting is 65536.

A2.1.2 Configurations

Hardware Configurations can be created, edited and deleted. These functions are available through the Buttons on the Configuration Manager interface or through the File and Edit Menus.

Running the Configuration Manager executable file shows the panel illustrated below.

The available configurations are listed in a Tree View, each comprising the following information:

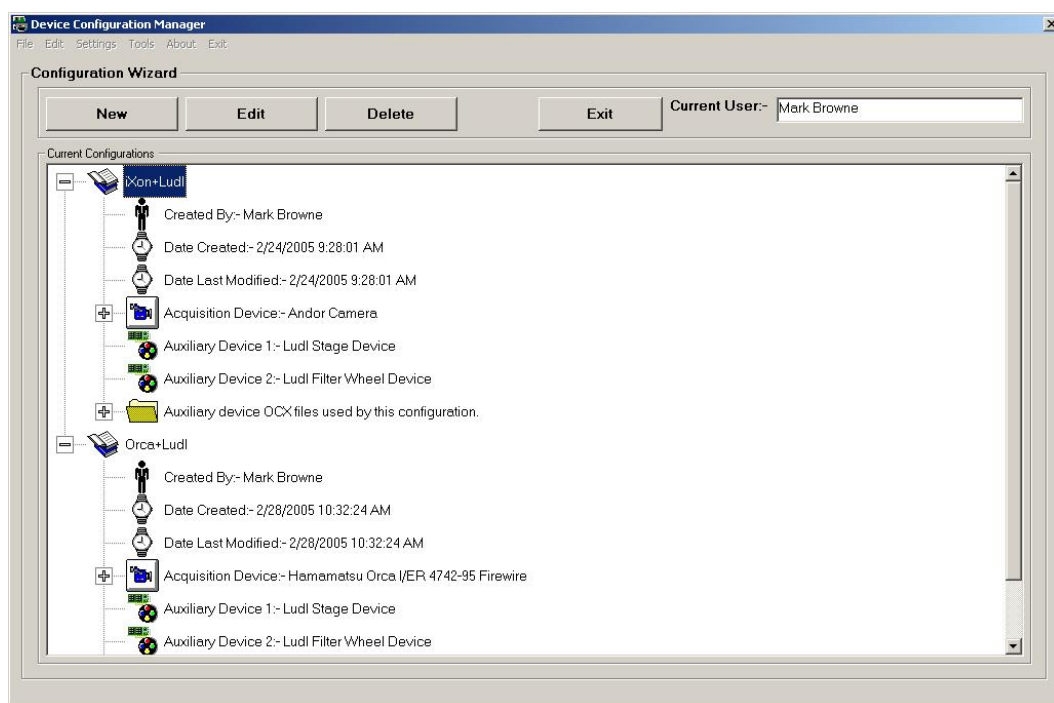

Created By The name of the Administrator who was logged onto the Local Machine when the Configuration was created.

Date Created The date the Configuration was created.

Date Last modified The date the configuration was last modified.

Acquisition Device The Camera Device used in the configuration.
The Camera Device Driver (OCX) used by the Camera Device can be seen by expanding this part of the tree.

Auxiliary Devices The Auxiliary devices that are contained in the configuration are listed.

Auxiliary OCX Files The Auxiliary Devices Drivers (OCX's) used by the Auxiliary Devices can be seen by expanding this part of the tree. This is useful for troubleshooting.

A2.1.3 Creating a New Configuration

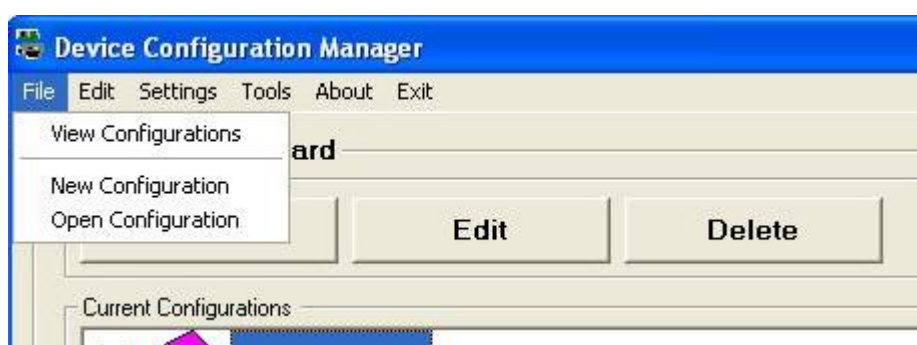

Pressing the **New** button or selecting the **New Configuration** item from the Configuration Manager menu launches the Configuration Wizard.

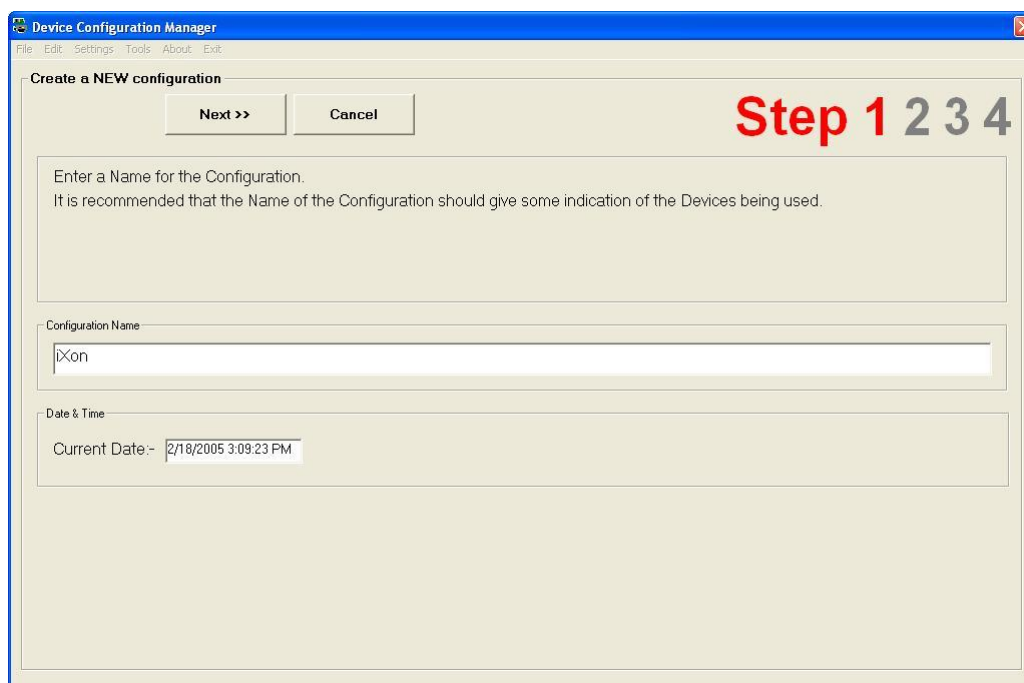

Enter a name for the new configuration, this should reflect the devices that are to be included in the configuration set up.

Press **Next** to continue.

The second step is to select the camera that is going to be used.

If you are creating a **Fast LZ** configuration then you must select the “**Andor Camera with Piezo Z and Monochromator**”. Monochromator refers to the original Fast L source supported, but includes Andor laser combiner and Sutter DG4. And emission filter wheel and multiple shutters can be controlled in FLZ

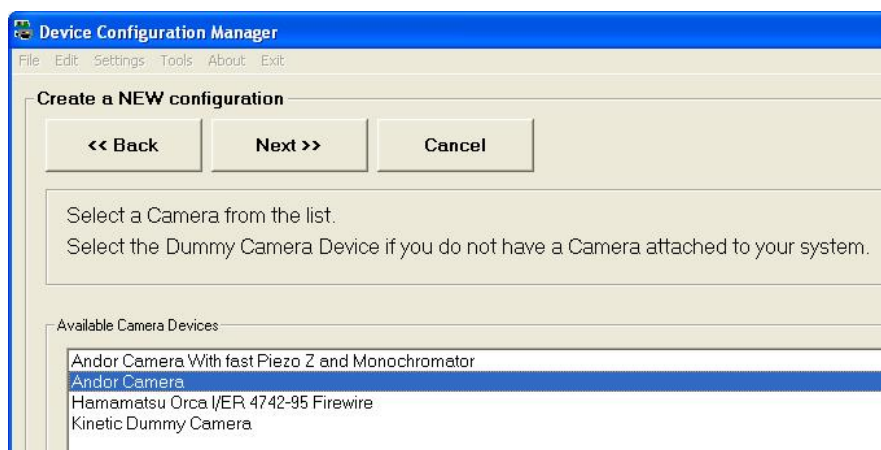

Click on the required camera device and press **Next** to continue.

Andor iQ USER GUIDE

The third step is to select the auxiliary devices that are to be included in the configuration.

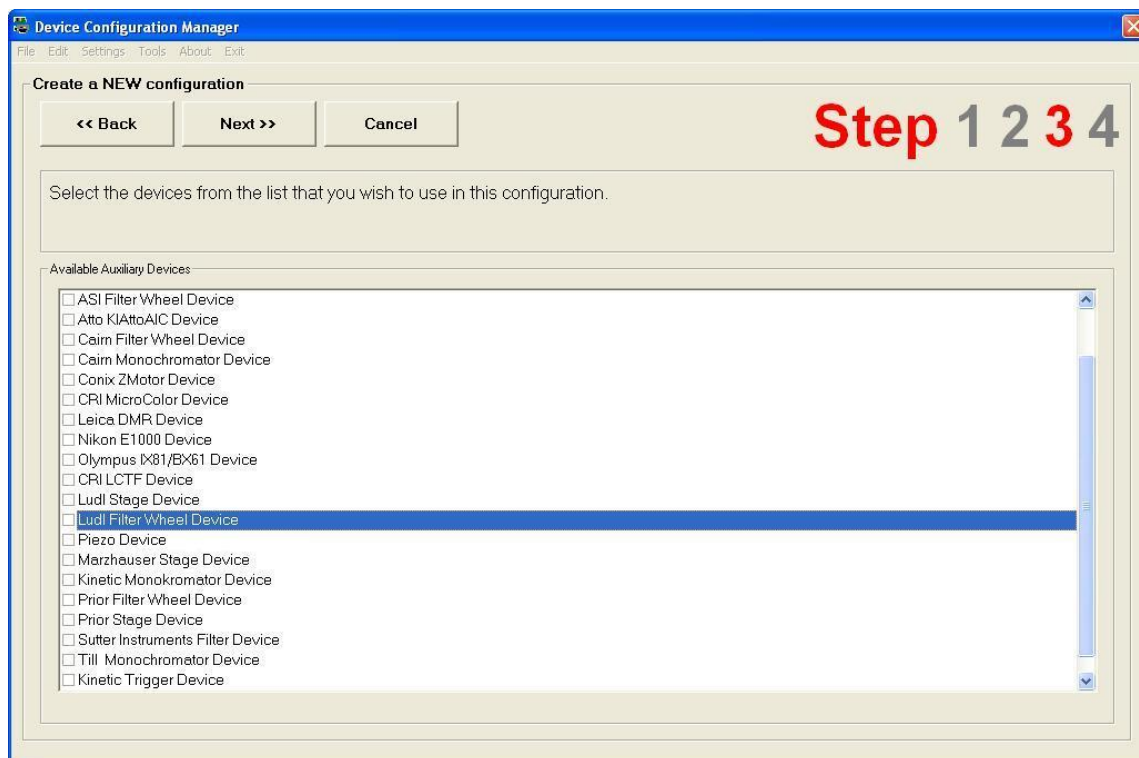

The devices are selected by checking the appropriate check boxes as illustrated in the example above. Press **Next** to continue.

A summary of the selected camera and auxiliary devices is displayed. At this point the user can edit the device selection if necessary, returning to the previous pages in the set up wizard by pressing the **Back** button.



The Andor Configuration Wizard can be exited at any time, ignoring any changes by clicking on the **Cancel** button.

Once the appropriate camera and auxiliary devices have been chosen, click on the **Finish** button to complete the device activation procedure.

The **Show REGSVR32.EXE** checkbox at the bottom of the dialogue is enabled by default. When the **Finish** button is pressed the devices will be registered and a series of message boxes displayed indicating whether the devices have been successfully registered. These messages can be inactivated by disabling the **Show REGSVR32.EXE** checkbox. We recommend leaving the box checked to make sure all devices register correctly.



A2.1.4 Editing an Existing Configuration



Select the appropriate configuration file name from the **Current Configurations** list displayed in the Configuration Wizard (please refer to **Section A2.2** for further details).

The chosen configuration can be modified by pressing the **Edit** button or selecting the **Edit Configuration** item from the Edit menu. A Wizard dialogue is displayed, similar to that used during the creation of new device configuration files (**Section A2.2**). The edit function allows modification of the configuration name and active auxiliary and camera devices

A2.1.5 Deleting an Existing Configuration



Select the appropriate configuration file name from the **Current Configurations** list displayed in the Configuration Wizard (**Section A2.2** for further details).

The chosen configuration can be removed from the **Current Configurations** list by pressing the **Delete** button or selecting the **Delete Configuration** item from the Edit

menu. A Wizard dialogue is displayed, similar to that used during the creation of new device configuration files (**Section A2.2**).

Before the selected configuration is removed from the **Current Configurations** list, the user will be required to confirm that they want to delete the selected file.

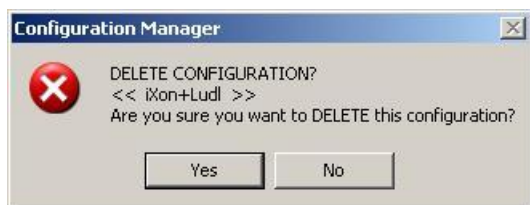

The selected file name to be deleted will be displayed within the << >> brackets as shown in this example.

Press the **Yes** button to delete the configuration. Clicking on the **No** button cancels out of the file deletion process.

A2.1.6 Managing Old Configurations



Selecting the **Open Configuration** item from the File menu displays the following page:

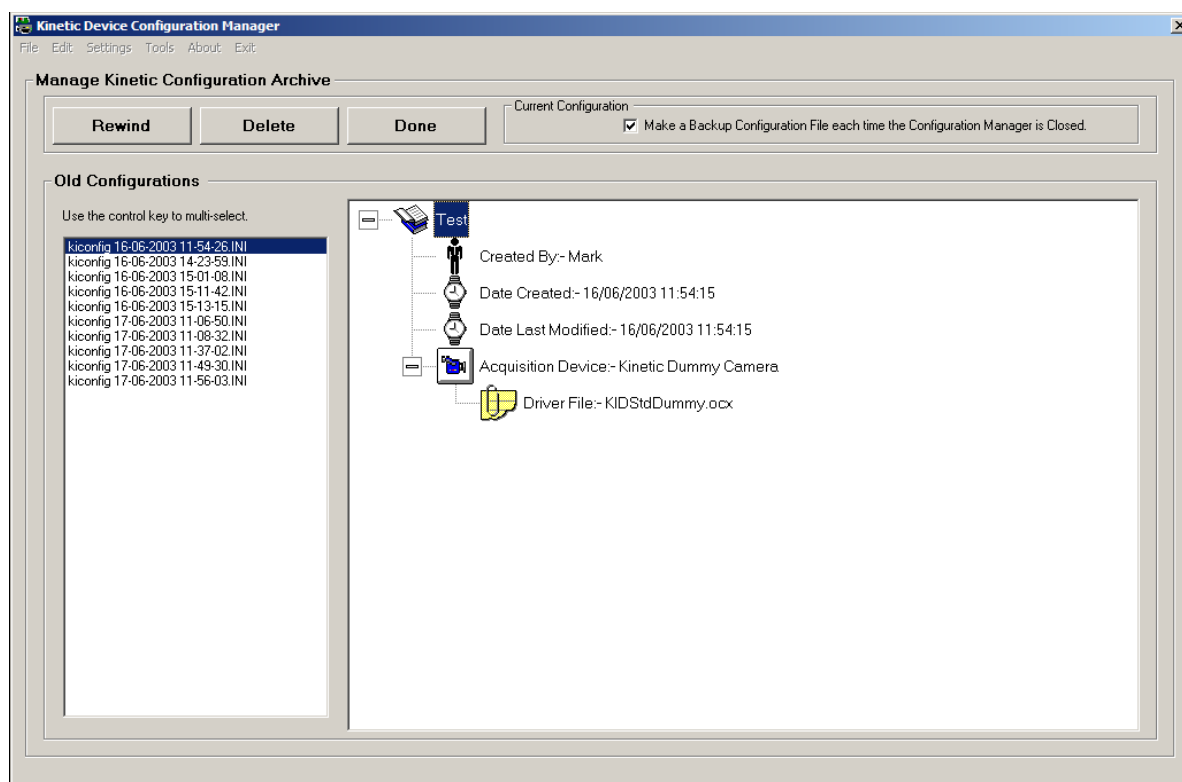

The Configuration Manager automatically saves a backup version of the configuration file to an Archive folder, every time it is closed. This ensures that no configuration data is lost and allows previous configurations to be recovered, should the current configuration file become corrupted or accidentally deleted.

A catalogue of archived configuration files can be found in the **Old Configurations** list on the **Manage Configuration Archive** as shown above. The details of each configuration file are displayed in a Tree View structure in the right hand panel. Files are selected by clicking on the appropriate file name using the left mouse button. The Tree View is expanded by clicking on the “+” icon.

The **Make a Backup Configuration File each time the Configuration Manager is Closed** checkbox shown at the top of the dialogue remains active by default. This ensures that back up copies of configuration files are created each time the Configuration Manager is closed. The archive facility may be deactivated by disabling the checkbox.

Unwanted configuration files can be removed from the **Old Configurations** listing by

selecting a file and then pressing the **Delete** button.

Selecting the appropriate file and clicking the **Rewind** button activates a previously archived device configuration file.

Clicking on the **Done** button exits the **Manage Configuration Archive** dialogue.

A2.1.7 Settings



The Settings drop down list is used to edit Global Configuration settings, view Software Protection Key Settings and to Enable a Demo Version on the software.

A2.1.7.1 Global Configuration Settings

For Details on Global Configuration Settings see **Section A2.1**.

A2.1.7.2 Software Protection Key

Selecting **Software Protection Key** from the drop down list opens the Software protection Troubleshooter Page.

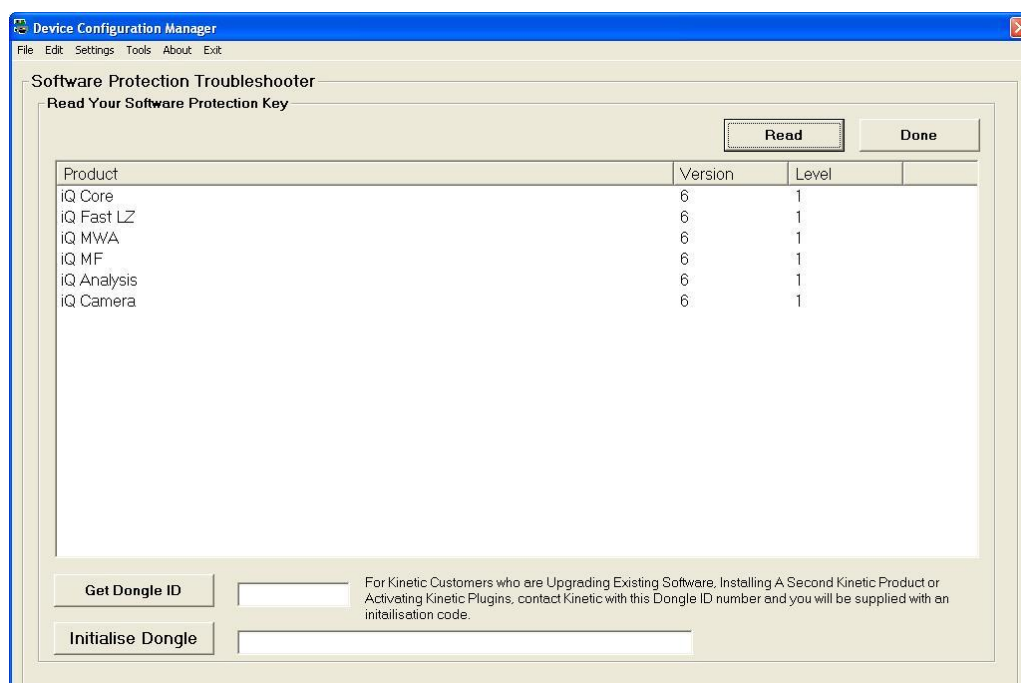

Select the **Read** button to list programs enabled on dongle. Select Done when complete.

A2.1.8 Troubleshooting ActiveX Registration



The **Tools** facility is used for registering Andor ActiveX Components, upgrading device drivers, installing Andor Plug-In software modules and troubleshooting

hardware devices.

A2.1.8.1 Registering and Unregistering ActiveX Components

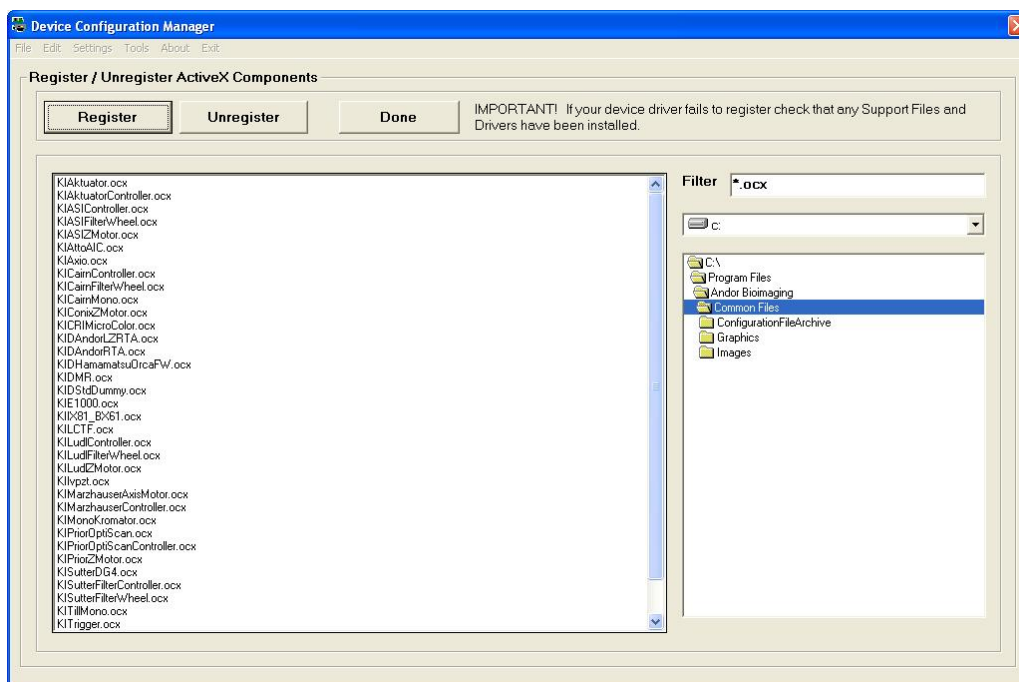

Selecting the **Register / Unregister Any ActiveX Component** menu item displays the following dialogue. (Please note the '**regsvr32.exe**' file must reside in the same folder as the ActiveX component for the registration process to work correctly).

Select the file to be registered / unregistered by defining the correct file path in the right hand panel and highlighting the appropriate file name in the left hand panel. The files displayed are determined by the file extension entered into the **Filter** text box.

Files are registered or unregistered by clicking on the **Register** or **Unregister** buttons, respectively.

Done exits from the Register / Unregister Any ActiveX Component menu.

A2.1.8.2 Registering and Unregistering Plug-Ins

Selecting the **Register / Unregister A Plugin Device** menu item displays the following dialogue:

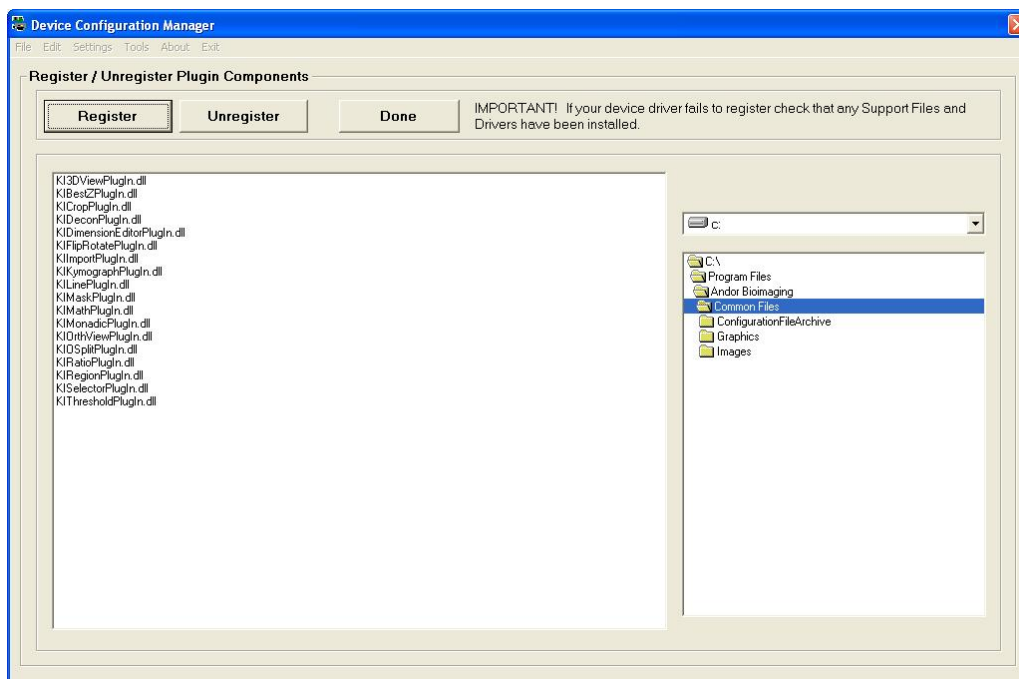

Select the file to be registered / unregistered by defining the correct file path in the right hand panel and highlighting the appropriate file name in the left hand panel. The default folder for Plug-In software modules is the '**Andor Bio-imaging\Common Files**' folder.

A2.1.9 About Andor Technology

		Bioimaging Division	
		www.AndorIQ.com	www.kineticimaging.com
UK Office		US Office	
The Stables Strelley Hall Nottingham, UK NG8 6PE	Tel: (+44) 115 906 1354 Fax: (+44) 115 906 1353 e-mail: info@kinetic-mail.co.uk	100 Southcenter Court Suite 900B Morrisville NC 27560, USA	Tel: (+1) 919 467 0607 Fax: (+1) 919 467 0608 e-mail: info-us@kinetic-mail.co.uk
<input type="button" value="OK"/>			



Appendix 3 – Hardware Device Setup

A3.1 Hardware Devices

The hardware devices included with your system can be set up and controlled by pressing the **Device Setup** button on the Acquisition dialogue or the Image window tool bar.

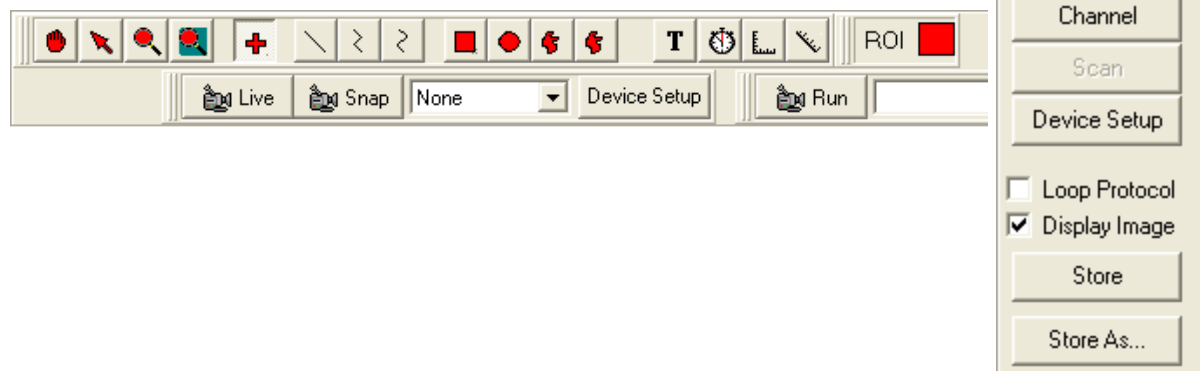

This opens the **Acquisition/Auxiliary Devices** dialogue, which contains pages for the setup and control all your hardware devices. The page tabs available for a particular system depend upon which devices have been activated for that system, using the Configuration Manager in the Andor Bio-imaging Program Group (**Section 2.3.1 and Appendix 2**).

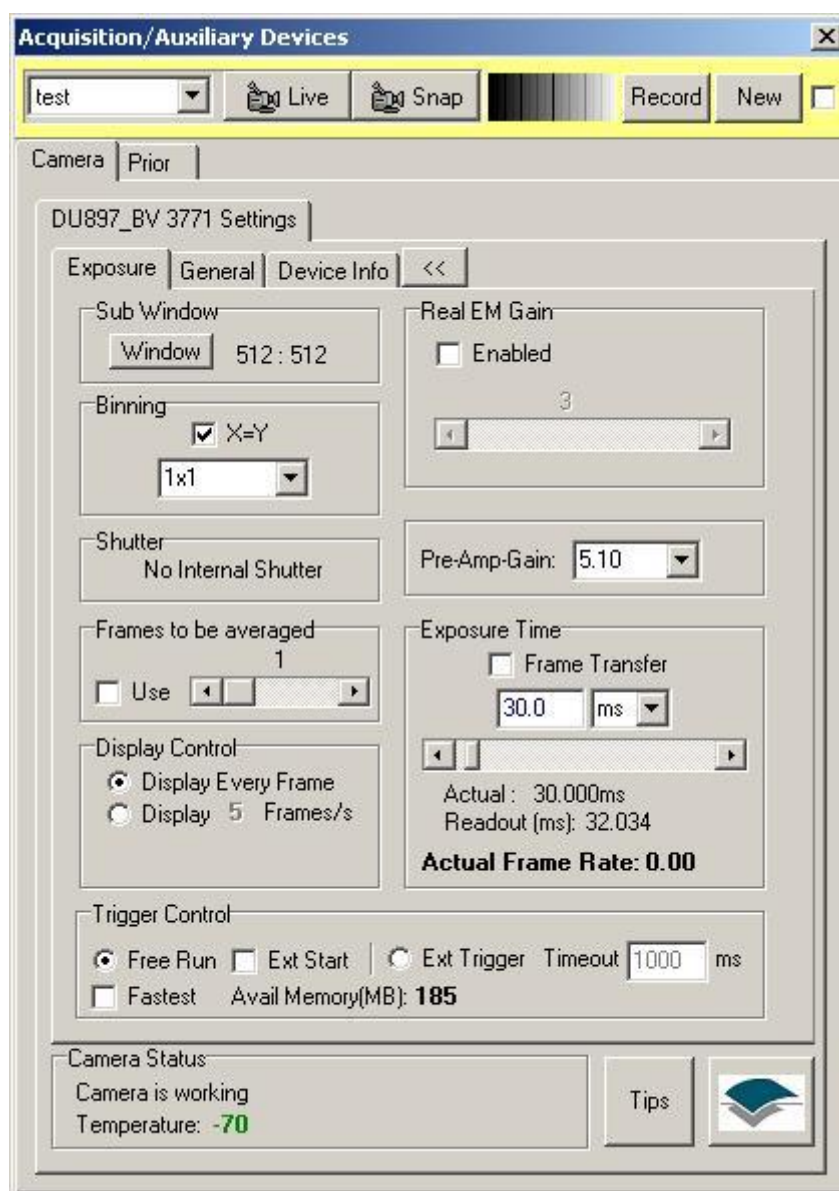

Note: In the above example, there is only one device and the camera, each device is accessed from a separate page tab. If more devices are connected than can be viewed in scrolling arrows on the right of the page tabs are present use them to scroll through the devices.

The subsequent sections of **Appendix 3** describe the setup and control of all hardware devices currently supported by Andor Technology.

A3.2 Andor iXon

Andor iQ is most often used for fluorescence microscopy and with the Andor iXon series of cameras. This is an EM (electron multiplying) CCD (charge coupled device) camera. The iXon family currently consists of 5 basic models with different pixel densities and EMCCD chips as follows:

- **iXon3 860:** Back illuminated with 128 x 128 x 24 μm pixels, running at 10MHz max with peak QE of >90%.
- **iXon3 888:** Back illuminated with 1024 x 1024 x 13 μm pixels, running at 10MHz max with peak QE of >90%.
- **iXon3 885:** Front illuminated, virtual phase with 1004 x 1002 x 8 μm pixels, running at 35 MHz max with peak QE of 65%.
- **iXon3 897:** Back illuminated with 512 x 512 x 16 μm pixels, running at 10MHz max with peak QE of >90%.
- **iXon Ultra 897:** Back illuminated with 512 x 512 x 16 μm pixels, running at 17MHz max with peak QE of >90%.

Other non-iXon Andor cameras supported by iQ are:

- **Luca R and S:** Economical EMCCD range, with 1004 x 1002 x 8 μm pixels (R), 658 x 496 x 10 μm pixels (S), running at 13.5MHz with peak QE of 65% (R), 52% (S).
- **Clara:** Interline CCD camera, with 1392 x 1040 x 6.45 μm pixels, running at 20MHz max with peak QE of 62%.
- **Neo/Zyla:** sCMOS, deep-cooled camera, with 2560 x 2160 x 6.5 μm pixels, running at 560MHz max with peak QE of 57%.

Although this section is mainly concerned with describing the setup and operation of iXon cameras many of the settings described also apply to the other cameras.

A3.2.1 Requirements

A3.2.1.1 Hardware

To handle data transfer rates of 10MHz readout over extended kinetic series, a

powerful computer is recommended; such as 2.4 GHz Pentium (or Better), 1 GB RAM and separate fast (e.g. 10,000rpm) hard drive for Image Disk operations. Also must be a PCI-compatible computer where the PCI slot has bus master capability. The computer must have an available auxiliary internal power connector and 32 Mbytes of free hard disk space.

A3.2.1.2 Drivers

Andor sCMOS cameras (Neo and Zyla) require the 3rd party “BitFlow” cameralink driver. In iQ 2.6 and later, this driver package is bundled in the iQ installer. For earlier versions of iQ, the package is available from the downloads section of www.andor.com or on your iQ CD. Different releases of this package are required for different versions of iQ:

iQ release	Driver package required
iQ 2.6 and later	Included with iQ installer
iQ 2.5 and iQ 2.5.1	BitFlowInstallerForIQ_2.5.exe
iQ 2.3 through to iQ 2.4.4	BitFlowInstallerForIQ_2.4.exe

If 2 Andor sCMOS cameras are attached to the system, you must not start up a 2nd instance of iQ while the 1st instance of iQ is currently acquiring images from one of the cameras. Doing so will disrupt the acquisition.

A3.2.2 On Start-up of iQ

When starting iQ, the user will first be prompted to select the correct configuration. You may then be prompted for a camera selection, if so make sure to select the correct camera model. The camera model and SN can be located on the back of the camera on the information sticker.

Once iQ has fully initialized access the camera setup from the **Device Setup** button on the main iQ window.

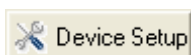

Each piece of hardware in the selected Configuration Manager profile will have a tab labeled accordingly. For camera setup and control select the Camera tab.

A3.2.3 Overview of Cameras within the Device Setup.

Shown on the following page, the Device Setup window allows control of all of the camera's settings. Note that the title of the main tab, in this case "DU897_BV 3303" contains both the model (897) and serial (3303) of the camera in use. This can be useful information when contacting Andor Technical Support or telling cameras apart on multiple camera systems.

Before getting into the details of the different camera parameters it's worth noting the various sections and tabs that constitute the device setup window.

- **Channel Controls** is located at the top of the Device Setup dialogue. This allows the user to: Select a channel using the Channel Select button, go live or snap using the named buttons and to record any channel changes via Record button.
- **Command Status** is located at the bottom of the Camera tab. This will signify the camera operating status. The user can also press the Andor Icon under the reset button to display the About Box or the Tips button to show advice on camera setup.
- **Camera Selection** allows additional cameras to be added and selected to/from the configuration.

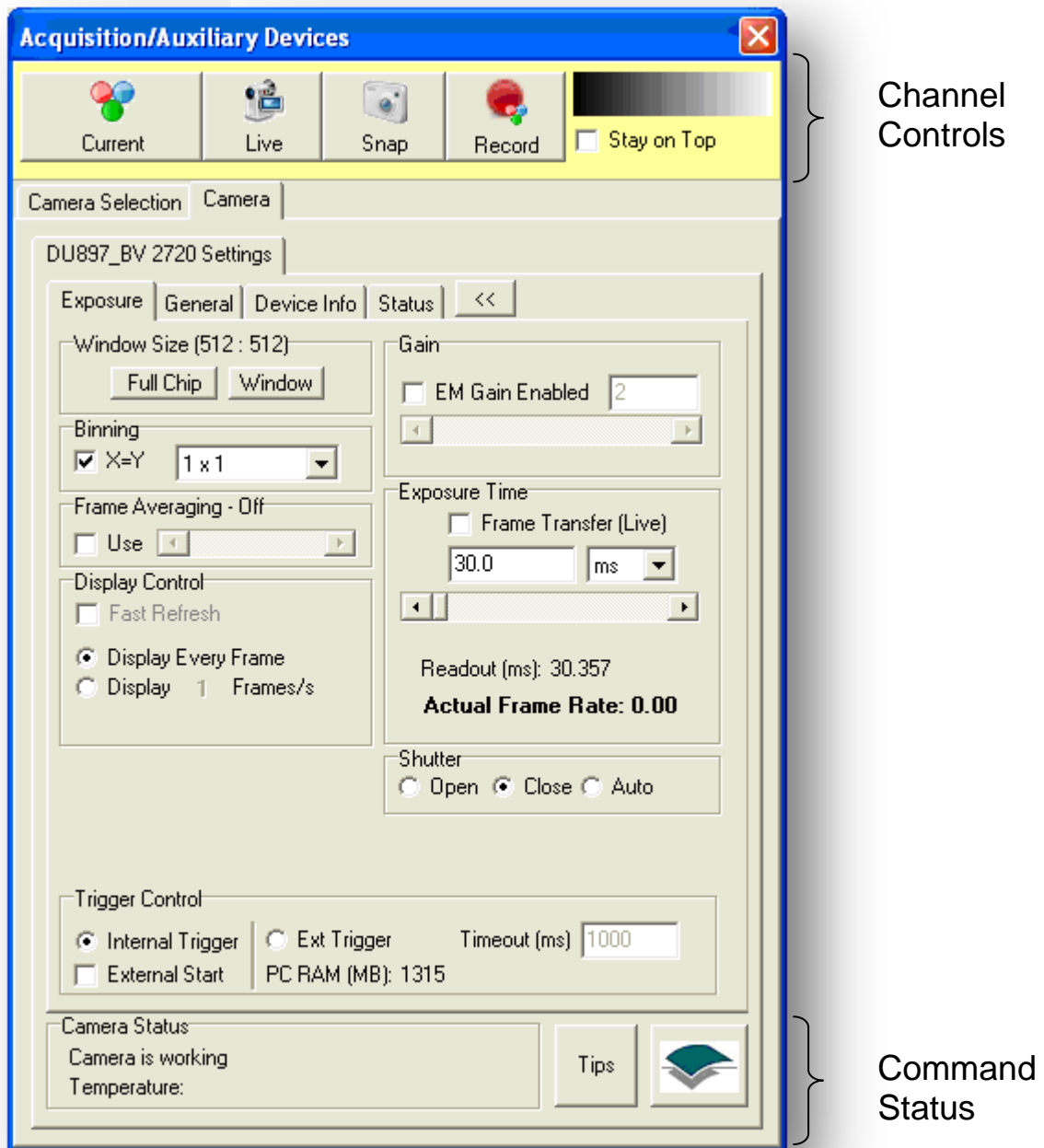

- **Exposure** and **General** tabs. These two tabs allow control and acquisition setup of the various camera parameters. The general tab contains more advanced settings, is locked and should only be modified by persons familiar with camera settings.
- The **Device Info** tab provides information on the currently selected camera:

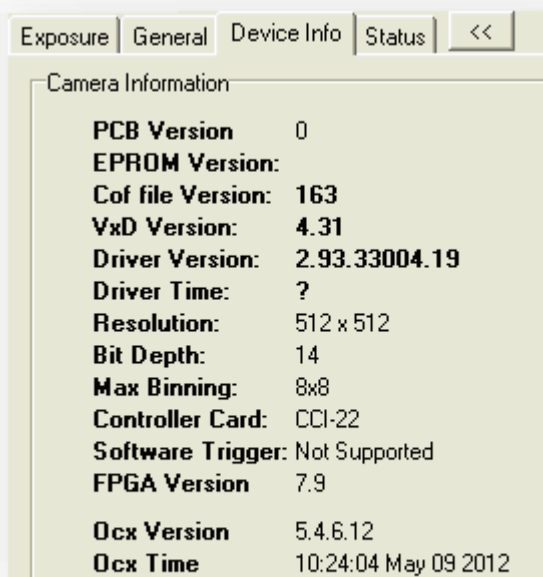

- The **Status** tab displays run-time relevant information to the user during protocols.

A3.2.4 Main Camera Settings

These settings are grouped together in the Exposure tab and are described below in approximately decreasing order of how often they are likely to be used or changed. Note: When finished making changes to the camera settings that you wish to remain active, remember to press the “Record” button to store the settings in the Channel (see section 4.2 for more details).

Useful Tip: the true intensity of the pixel under the mouse cursor in the image can be seen at the bottom of the Image Window in Andor iQ. Shown below, the value



“184” is the intensity of the pixel under the mouse cursor of the active image. By moving the mouse over the image, the true brightness can be seen and adjustments made accordingly. This value is not affected by display effects, such as the LUT (look up table, e.g. colour), Mapping or Automap (see section 5.1 for more details).

A3.2.4.1 Exposure Time

Suggested starting value: 30 - 100 ms.

Much like an ordinary camera, this is the length of time light is allowed to reach the sensor. A longer exposure time means both a brighter image, but also a slower acquisition speed.

Note: Camera exposure times will automatically adjust when binning is changed.

The **Readout** Time is the time taken to move all of the image data, post exposure, through the shift registers, amplifiers and ADCs into the onboard memory (USB2 cameras and Neo) or the computer RAM (PCI iXon cameras).

The **Actual Exposure Time** displays the current exposure time, which may not necessarily equal the set exposure time. For example when running in Frame Transfer or Overlap mode the minimum exposure allowed is approximately equal to the readout time.

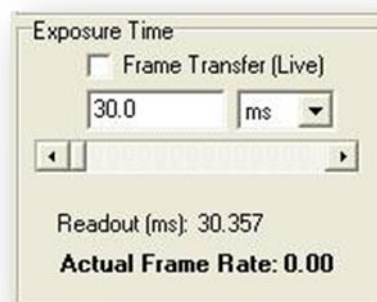

A3.2.4.2 EM Gain

Suggested starting value: 50

In simple terms, increasing the EM (electron multiplying) Gain of the camera will increase the brightness of the image. For most fluorescence microscopy work, a good starting point is perhaps 40 – 60 for most iXon cameras. This is because the typical “read noise” of the iXon camera is around 50 electrons. Setting the EM Gain to around this value makes sense because EM Gain is specifically used to overcome this source of noise. Please check your camera documentation for more information on the read noise of your camera under various speeds.

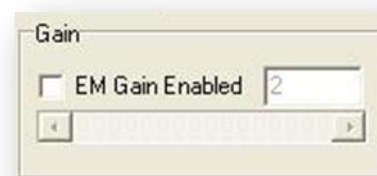

Note: For the best image quality it is recommended to stay below 300, but there is no other reason not to use higher values if very high speed acquisitions (light levels not

greater than the order of tens of photons per pixel) are required. If high gain is used for photon counts higher than this accelerated ageing of the sensor can occur.

Note: When using multiple Channels in a Protocol, it is recommended that they each use the same EM Gain value. This is because the EM Gain takes a short time to stabilise between two different values.

A3.2.4.3 Frame Transfer (Live)

This checkbox will enable Frame Transfer mode of the camera, but only while Live. To enable Frame Transfer during a Protocol, the “Snap” item in the nD Protocol Tree must be changed from “Frame” to “Stream” (see section 4.4.6 for more details). Frame Transfer is used when the highest acquisition speeds are required, but may result in images being taken while other devices (e.g. filter wheels, XY stages, focus devices) are moving, so is best utilised for simple Protocols. In Frame Transfer mode, the exposure time and the readout time occur at the same time. For example, if the exposure time is 30ms and the readout time is 30ms, the total time for the image to be taken will be 30ms. With Frame Transfer disabled, this would be 60ms.

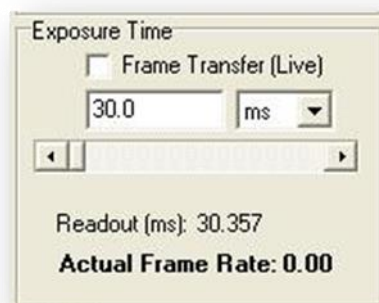

Note: When running in Frame Transfer or Overlap mode the minimum exposure allowed is approximately equal to the readout time.

A3.2.4.4 Binning

Suggested starting value: 1x1

This setting will “bin” (add together) neighbouring pixels to create a single “superpixel”. For example, 2x2 will take each grid of four pixels and convert them into one in the resulting image. This results in two important changes in the image – (1) lower resolution and smaller data size and (2) faster speed (or a brighter image for the same exposure time). For example, imaging large, dark or fast moving objects, binning can help

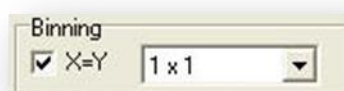

achieve a brighter, faster image and also a smaller final dataset.

Note: In Live mode, iQ automatically changes the exposure time to maintain the same image intensity. E.g. 1x1 binning at 100ms will automatically change the exposure time to 25ms if the binning is changed to 2x2. If binning is required for the Protocol, it must be changed in the nD Protocol Tree.

Note: When changing the binning, the effect on the readout time can be seen in the Device Setup window.

Note: Binning can be set in the protocol with keyword “Binning”. This avoids the need to have different channels for each binning. This also means that binning in all channels can be adjusted in one setting.

A3.2.4.5 Window Size

Suggested starting value: Full Chip

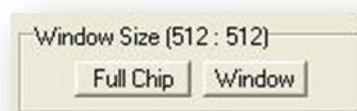

Drawing a rectangle ROI (region of interest) on the image then clicking the “Window” button will result in only that region of the image being captured. To return to the full image size, click the “Full Chip” button. The two main reasons to enable this feature are (1) to reduce the amount of data being collected, for example only recording the specific feature of interest and (2) depending on the exposure time, to increase the speed of acquisition. Due to the way the Andor iXon and Luca operate, it is only the vertical size of the image that affects the speed. Knowing this, a letterbox or horizontal window can be the most effective way to capture as much of the image as quickly as possible.

Note: When changing the window size, the effect on the readout time can be seen in the Device Setup window.

Note: The Full Chip image size depends upon the binning values selected.

Note: Right clicking the region on the image view and selecting edit will allow input of precise values (remember to click the Window button on the Device Setup tab).

A3.2.4.6 Frame Averaging

Suggested starting value: Disabled

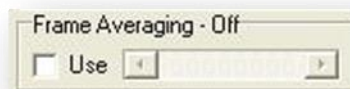

Enabling this feature will result in the average of several frames being captured. For example, if 8 is chosen, only one image will be captured for every 8 exposures. This may result in a nicer image, but at a speed at least 8 times slower. This feature can be useful for taking single images, e.g. a “Snap” when the image contains a lot of random noise. This is sometimes the case at very short exposure times, although in many cases, using a longer exposure time will result in a better image.

Note: The same result can be achieved after acquisition by using the “Average” operation in the “Image Math” plugin from the Process menu.

A3.2.4.7 Display Control

This option may affect the speed of acquisition if “Display Every Frame” is selected and the frame rate is very high (e.g. 100 fps). Try reducing the number of frames to be displayed if this is the case.



The “Fast Refresh” option is useful if using long (e.g. 1 second) exposures. It will simulate the brightness of the exposure on the screen but maintain a reasonable frame rate. Captured data will not be affected by these settings.

A3.2.5 Other Settings

A3.2.5.1 Shutter

If the camera has a shutter, iQ will generally control it by opening it when the camera is first used and keeping the it open until the software is closed. The Auto setting will automatically open and close the shutter in phase with the exposure. This setting is not recommended as a high number of transitions can lead to shutter fail.

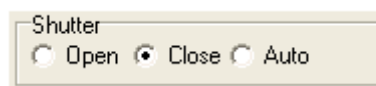

A3.2.5.2 Trigger Control

Typically the camera is operated in “Internal Trigger” mode. In cases where you wish to connect an external source of trigger (5 V TTL) to the camera’s “Ext Trig” pin, it can be switched to “External Trigger”, where each image requires a trigger, or “External Start”, where a single trigger starts the Protocol.



In addition, when two cameras are operated in synchronous mode, for example with the Andor TuCam, the first camera will be set to “Internal Trigger” and its “Fire” pin connected to the second camera’s “Ext Trig” pin. The second camera is set to “External Trigger” mode and thus the two cameras capture frames at the same moment.

The “Timeout” specifies how long the software will wait until it aborts the image capture if the camera does not receive the trigger signal.

A3.2.6 Advanced Settings

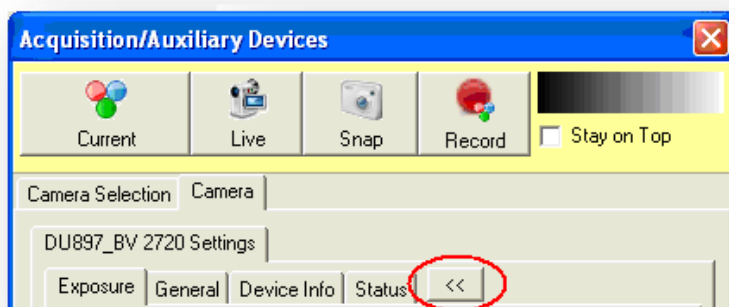

When the camera is Idle, further camera options can be seen by clicking the >> button to reveal or hide additional tabs. Within the “General” tab, there are a number of camera settings that some advanced users may find useful. This interface will need to be unlocked by clicking the lock icon to access the settings.



A3.2.6.1 Image Orientation

The “Image Orientation” tab allows the image from the camera to be flipped and / or rotated to correct for things such as XY stage movement between the eyepieces and the on-screen image from the camera.

Note: This setting may reduce the acquisition speed and affect any active FRAPPA calibrations. The setting is stored on a per-Protocol basis.

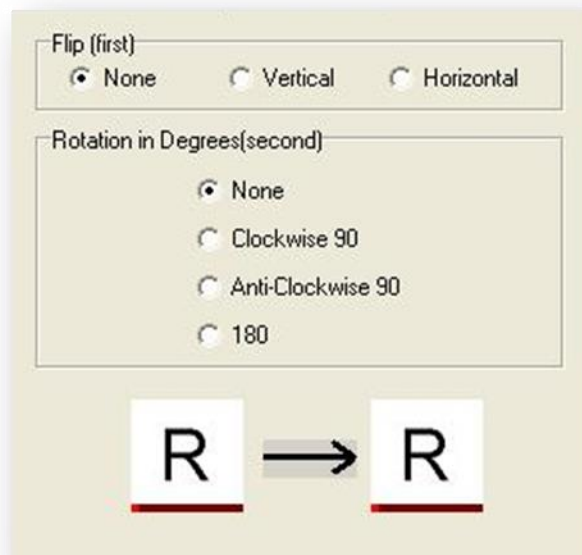

A3.2.6.2 Speed/Amplifier tab

The **Readout Speed section** allows the camera’s data readout speed to be increased (for example to increase the frame rate) or decreased (for example, to reduce noise for long exposure times). In

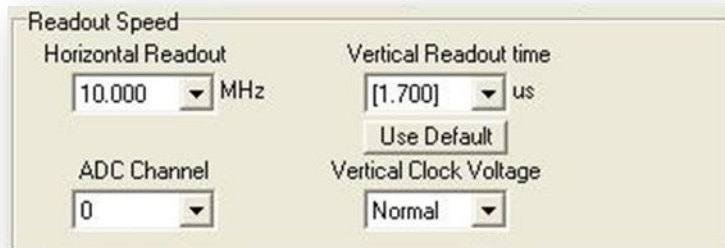

the course of readout, charge is moved vertically into the shift register, and then horizontally from the shift register into the output node of the amplifier.

Horizontal Readout

Suggested starting value: maximum available for the camera.

In most cases, this is best set to the highest value. If long exposures (e.g. 1 second) are needed and the signal is very weak, decreasing this speed may improve the image quality by reducing the read noise. The specification sheet supplied with the camera will give the noise values for each readout speed.

Note: The effect on the readout speed can be seen in the Exposure tab as detailed

earlier.

Vertical Readout time

Suggested starting value: the maximum value contained in square brackets [].

Because the units for this setting are μs (microseconds), the larger the value selected, the slower the speed. Choosing a lower value can be useful when the very highest speeds are required and a window is being used, however, at very high speeds (very small values), the image may be distorted, leading to artifacts or image tearing. This can be improved or corrected by increasing the “Vertical Clock Voltage” option, described below.

Note: The values in square brackets [] are outside of the operating specifications of the CCD and are not guaranteed to operate without image artifacts. However, in most cases, the highest value of these can be used with no ill effect.

Vertical Clock Voltage

Suggested starting value: Normal.

This option can be used to correct for image artifacts introduced by aggressive vertical readout times. Increasing this value may help to stabilise the image if issues are seen. It will however introduce additional CIC (clock induced charge) events, which may be seen as small, bright spots.

ADC Channel

Suggested starting value: 0 (14-bit mode).

Some Andor cameras allow the ADC (analogue-to-digital converter) to be switched between 14-bit and 16-bit mode. A value of zero corresponds to the default (14-bit) converter and a value of 1 for the 16-bit converter. Depending on the model of camera being used, switching to the 16-bit converter may also force a lower Horizontal Readout to be used. The 16-bit mode may be useful for long exposures or imaging samples that require a very high dynamic range. 14-bit mode offers 2^{14} greyscale values (around 16,000), 16-bit mode offers 2^{16} (around 65,000).

Output Amplifier

Suggested starting value: EM Port

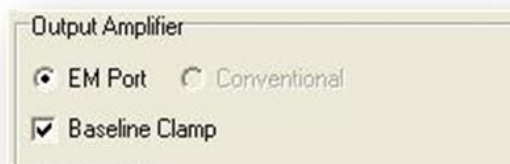

In addition to the ADC selection, some cameras allow the EM Gain to be bypassed and the Conventional amplifier to be used. This can be useful in some situations (for example very long exposure times or very bright signals) because EM Gain introduces its own noise to the signal (a factor of approximately 1.4 to the shot noise). In the vast majority of fluorescence microscopy however, the read noise is the limiting factor and EM Gain is specifically designed to overcome this.

Baseline Clamp

This should always be enabled.

This option ensures that the camera electronics adjust automatically to deliver a baseline count or intensity of about 100 for iXon, 200 for Luca and 500 for Clara.

Pre-Amp Gain

Suggested starting value: Maximum value available



This option is best thought of as a “conversion factor”. It determines the number of electrons in the CCD that are required to produce one count, or intensity value, in the image. For most low light work such as fluorescence microscopy, the highest value should be used. Its effect can be best seen when viewing a histogram of the intensity data, for example with the Mapping window (see section 2.7.1 for more details) or Region Histogram (from the Analysis menu). Please refer to the specification manual provided with the camera for further details.

A3.2.6.3 The Temperature/Shutter Tab

Temperature and Fan

This section allows the user to adjust the temperature to a specific value by moving the scroll bar. The selected temperature will show above the scroll bar. The actual temperature and cooling status will also be displayed underneath the scroll bar.

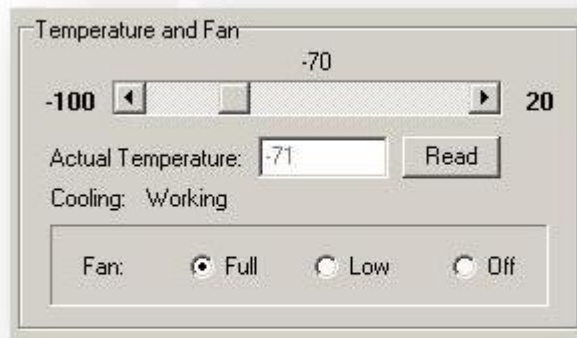

Cooling the CCD detector helps you reduce dark signal and its associated shot noise. Also, the impact ionization that yields gain has negative temperature dependence, increasing by a factor of 10 as the temperature drops from 0°C to -50°C.

The camera will commonly be run at -70°C for low light microscopy when the gain can exceed 3000 or 4000. Although the camera is not damaged by high levels of light exposure, we recommend that the gain be kept low when not in use to avoid excessive camera saturation and potential aging of the EM gain, which may need to be factory reset after thousands of excess saturation exposures.

The fan control allows the user to specify (if available) Full speed, Low speed or Off by selecting the corresponding radial button. The camera can be run only for short periods without the fan.

Shutter

Under settings the Check box for TTL (Transistor-Transistor Logic) High Open, signifies that the system will cause the output voltage from the controller card to go 'high' to open the shutter.

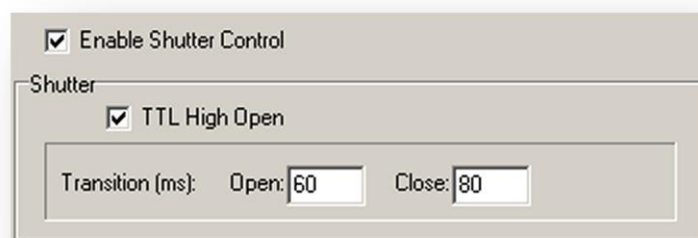

The Open/Close Transition time is the specified time the shutter will take to open or close. This time is used to give the shutter enough time to close before background data are acquired. The system ensures that a period of at least the duration of the Transition Time elapses between the shutter output signal entering the 'closed' state and commencement of background data acquisition.

A3.2.6.4 The Read Parameters Tab

For sCMOS cameras Speed/Amplifier tab is replaced with Read Parameters tab. The Read Parameter tab allows the user to choose the Pixel Readout Rate as well as the shuttering mode. It also lets the user enable the Spurious Noise Filter.

Spurious noise filter

The Spurious Noise Filter corrects for pixels that would otherwise appear as spurious "salt and pepper" noise spikes in the image. The filter actively identifies such high noise pixels and replaces them with the mean value of the neighbouring pixels. Enabling Spurious Noise Filter has no effect on the camera acquisition speed.

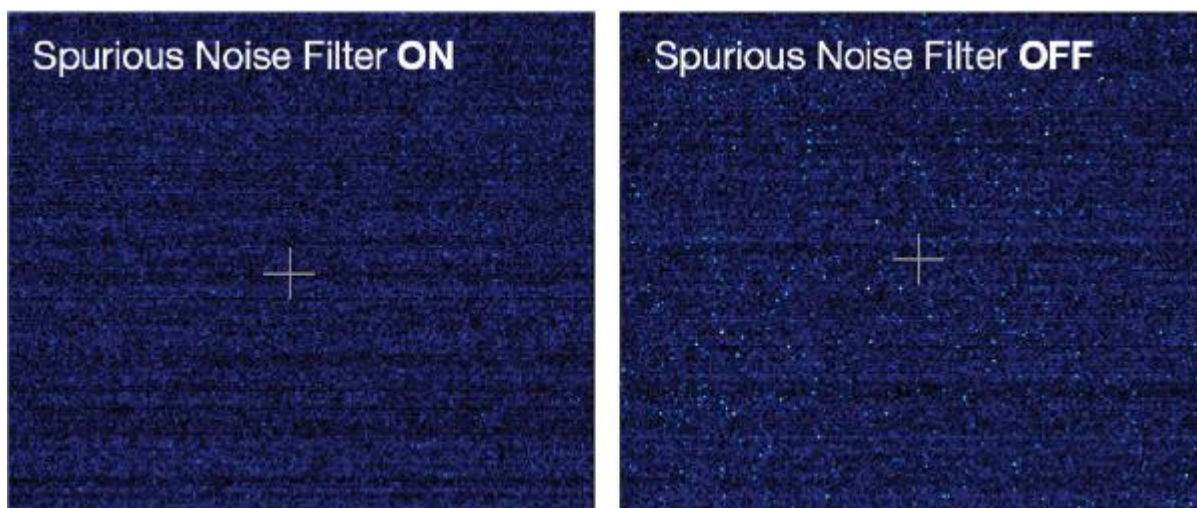

The above image demonstrates the effect of the Spurious Noise Filter on a dark image, 20 ms exposure, 200 MHz readout speed.

A3.3 DIO and DAC Card Installation for PCU and FLZ

A3.3.1 Introduction

Andor iQ Core controls external hardware for Trigger and Event detection (PCU), while the Fast LZ module controls illumination (Monochromator, Sutter DG4 and AOTF) and Piezo Focus or Z motion. These devices require the inclusion of a PCI card into the computer and configuration of the card before use. This document gives a brief summary of the correct procedure to follow.

The recommended digital and DAC boards are manufactured by Measurement and Computing Inc.. Andor iQ uses two types of board: PCI-DIO24 or PCIM-DDA06/16. DIO24 is used PCU for TTL synchronization / isolation only. PCIM-DDA06/16 is required for PCU and/or Monochromator, Sutter DG4 and/or Piezo focus control.

A3.3.2 Installing Your DIO and/or DAC Card

The installation has four steps.

1. Shut down PC. Insert the PCI card into a free PCI slot.

Make sure that you use the recommended anti-static procedure (ground yourself with a wrist strap) to avoid damage to the board while handling.

2. Install driver for PCI-DIO24 or PCIM-DDA06/16 card

Start PC, ignore windows found new hardware wizard.

Insert Andor iQ installation CD into CD-ROM. Run Setup.exe from the installation CD.

Select Full installation of iQ then go to Auxiliary Devices page.

Select **Computer Boards DIO and DAC Control** to install driver for the DAC card, go through the installation by pressing next button (default) and select restart PC at the end of the installation.

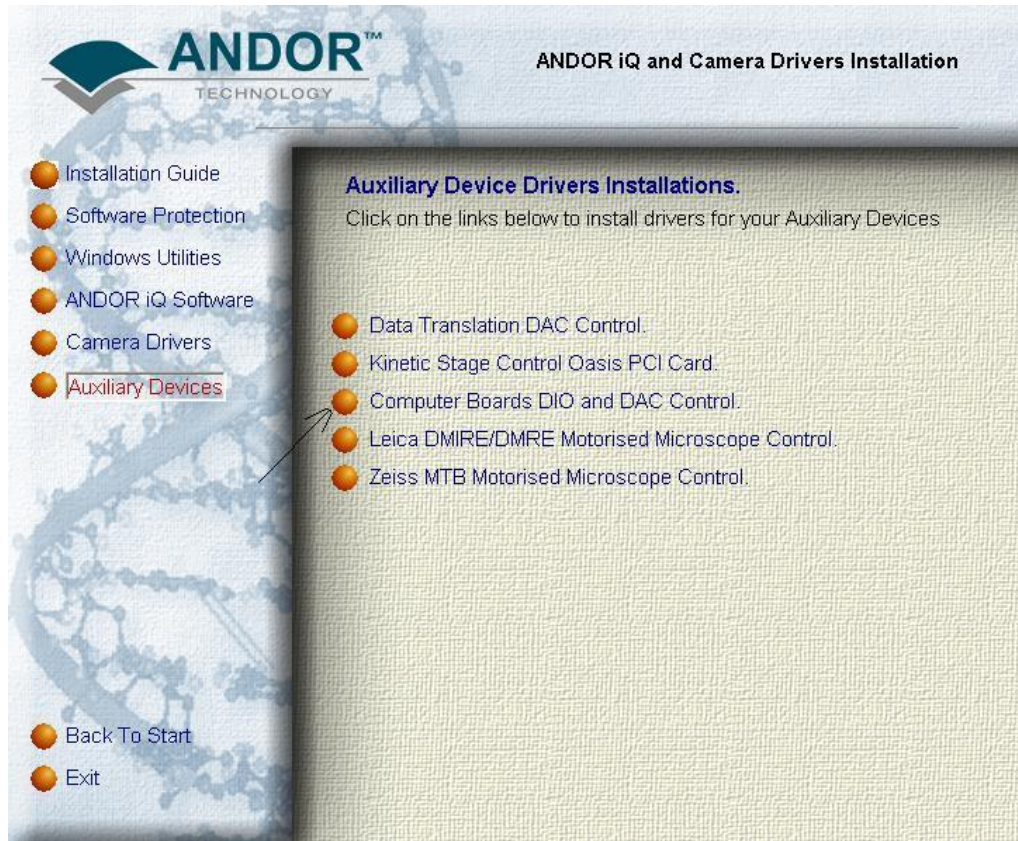

Selecting the Auxiliary Devices Options from the Installation CD shows the Options. Choose Computer Boards and Follow the Instructions.

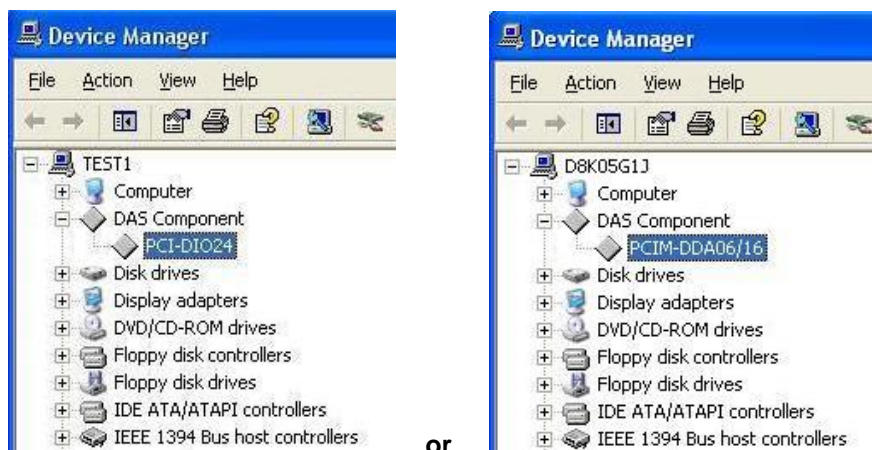

The above picture shows the appearance of Boards in the Device Manager after installation of board and drivers from iQ installation procedure.

After restart, select My Computer on your desktop, right click mouse to select

properties. Then select Hardware, Device Manager. You should be able to see the card listed there as shown.

3. Acquire Card Number

- After PC restart, run InstalCal from Start->All Programs -> Measurement Computing.
- InstaCal will automatically detect the card then a board number will be given as shown below.

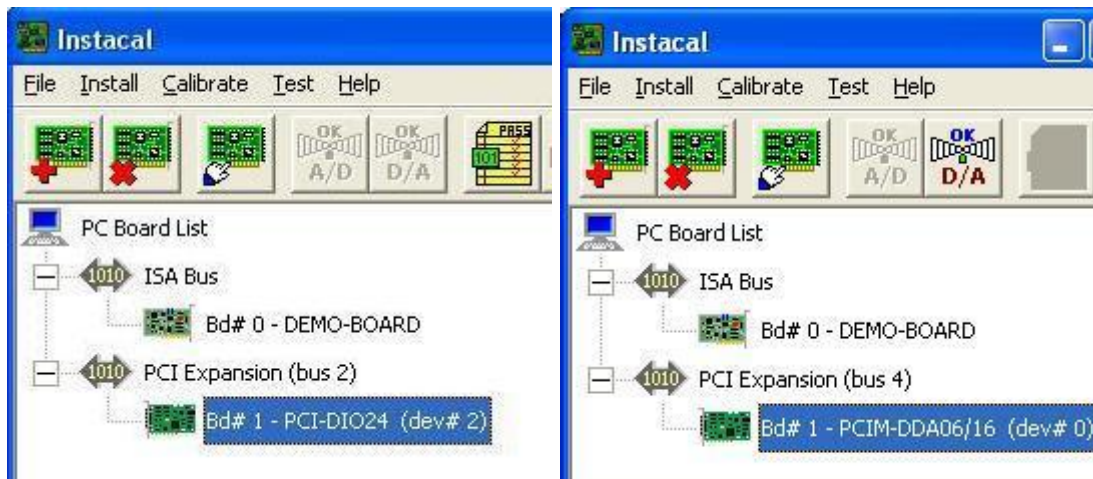

The above picture shows the card installed as Bd #1 in the Instalcal initialisation program. Exit InstaCal.

4. In Andor iQ the Local Machine Administrator Uses Device Setup

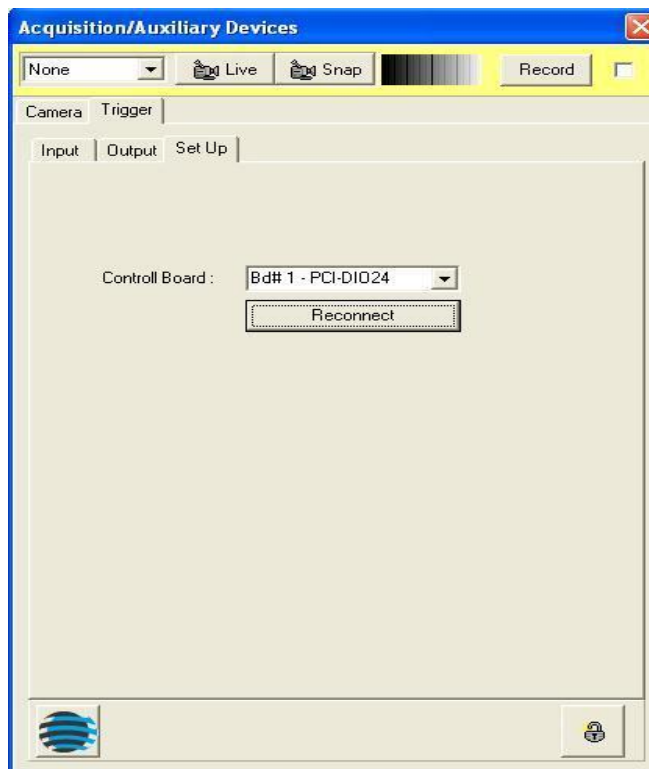

After you have built a Configuration with the Manager to use PCU or FastLZ, start Andor iQ and select the Device Setup dialog. Unlock the Setting controls and select the appropriate board. In the example shown right, Bd #1 is used as the controller board.

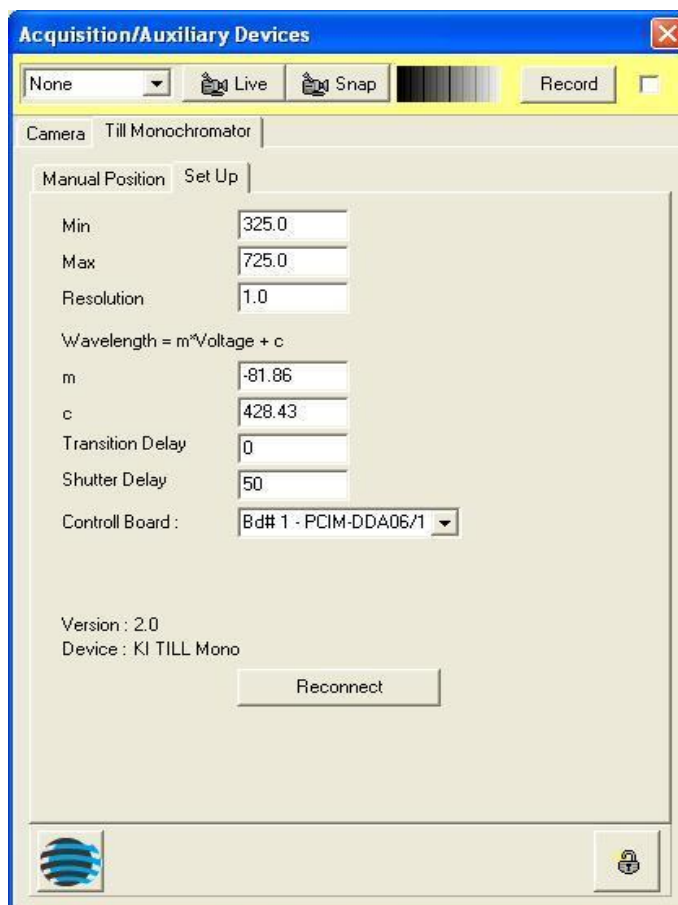

Andor iQ USER GUIDE

The picture shows selecting the board for control of PCU or FastLZ from the Device Setup Panel.

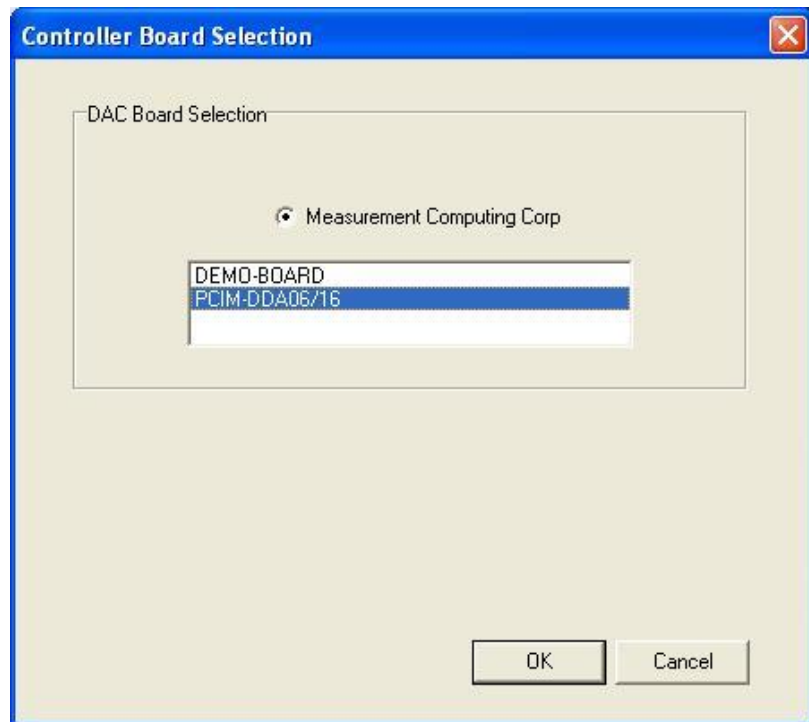

You have finished all the necessary installations. The card is ready for use.

A3.4 The Sutter Filter Devices

A3.4.1 The Settings Page

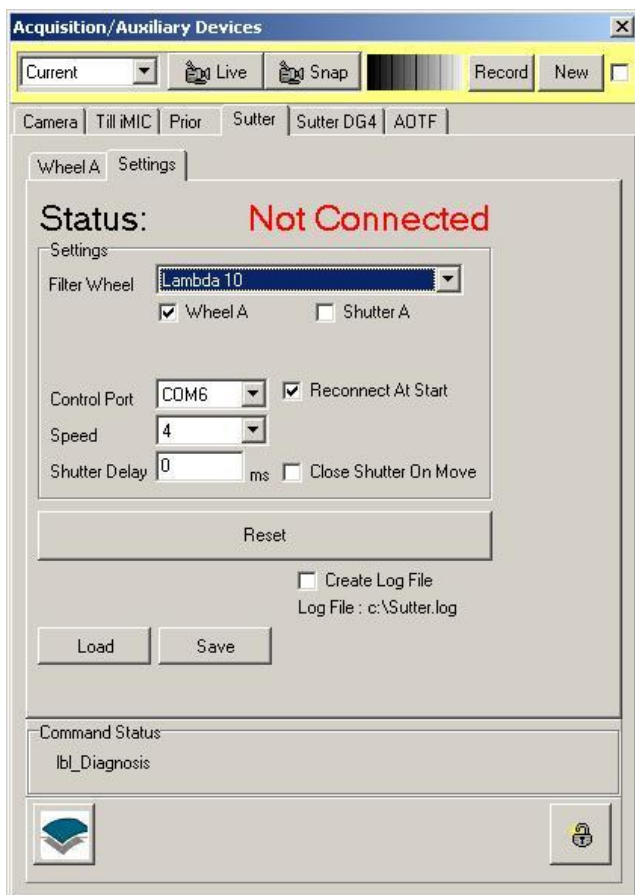

Sutter Instruments manufacture a range of filter wheels and light sources for imaging. These are supported by iQ with two device controllers to allow use with the **DG4/5** – a fast galvo switching source – and the **Lambda series** of filter wheel and shutter devices. As with all controllers accessed is via the **Device Setup** dialog. The figure left shows a configuration with both a **Sutter** tab and a **Sutter DG4** tab, illustrating that these can be controlled together.

The **Settings** page is used to Select the device type, speed, shutter delay and COM port for control. Load and

Save Buttons allow you to maintain details of filter information loaded into the wheel.

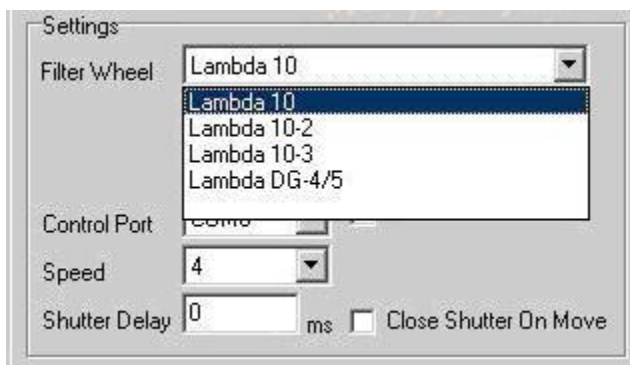

From the **Filter Wheel** dropdown listbox, select the filter wheel controller that you are using.

Available options are:

Lambda 10 - controls one filter wheel only.

Lambda 10-2 - controls up to two filter wheels (Wheel A and Wheel B) and one Uniblitz shutter.

Lambda 10-3 - controls up to three filter wheels (Wheels A, B, C). It can also control two shutter on ports A and B.

DG4/5 - the fast galvo-based light source with four or five positions. Switching time is <1.2 ms and shutter time is 500 μ s. This device can be driven from a separate controller with the same functionality. You will choose that controller if you also want to run a filter wheel with this controller.



When you select one of the filter wheel options, the interface will provide a set of check boxes to tell iQ what you want to control, as shown left. Check the boxes of components you want to control.



The filter wheel is controlled through one of the serial ports on your computer. From the **Control Port** dropdown select the port you are using.

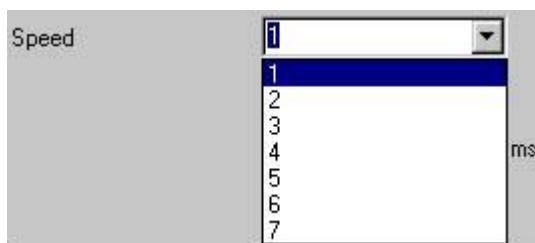

From the **Speed** dropdown listbox, select the speed at which the filter wheel will change position. Speed 1 is the fastest and speed 7 the slowest. **Note** not all speeds are guaranteed to function without correction

because filter load affects inertia and positioning performance. The device has a self-test utility for robust speed operation. Refer to the manual for more information.



The **Shutter Delay** describes the time taken in milliseconds to open the shutter and to close the shutter.

Simply enter the value into the text box.

The minimum delay value is very important for continuous readout cameras, for example video cameras and the Hamamatsu Orca 1. Specifying too low a value will result in the shutters opening and closing out of synch. Tests at Andor with a Meteor controlled video camera suggest that the minimum Shutter Delay for such cameras is 50 ms. A lower value will result in the first field of the current frame being acquired before the shutter has fully opened or closed. This will result in you seeing an image containing horizontal lines.

Note: If the Shutter State is set to Open-Closed (or Closed-Open), there will be one delay while the Shutter opens, the image will be acquired, and then there will be a second delay while the shutter closes.

If the Shutter State is on a single action (i.e. Open or Closed) then you will just see one delay.

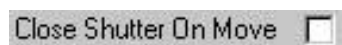
 The **Close Shutter On Move** command can be selected / deselected by clicking in the check box. When selected the checkbox is labelled with a tick and after moving the wheel to a new filter position, the shutter will automatically close.

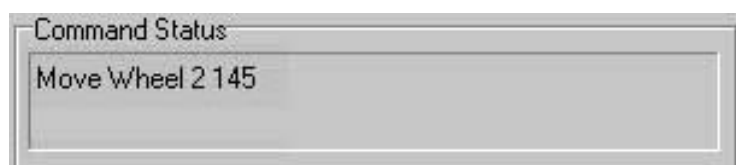

The command being written to the COM Port is displayed in the **Command Status** section of the dialogue. You should not send further commands to the filter wheel if a command is currently being written

Press the **Save** button to save the current settings to file. This will open a standard Windows save file dialogue, from which you can specify the filename, drive and directory to which to save the current settings.

The settings can be reloaded at a future date by pressing the **Load** button. This opens a standard Windows open file dialogue, from which you can select a settings file to load.

Pressing the **Reset** button will reinitialize the filter wheel. In the unlikely event that

the Andor Software stops talking to the Sutter Filter Wheel, pressing **Reset** can resolve the problem.

A3.4.2 Wheel Settings

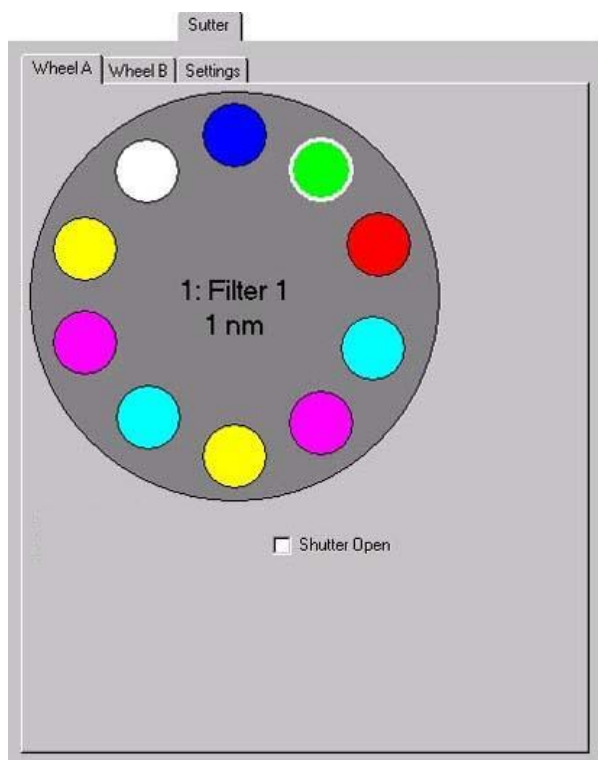

The Lambda 10-X controllers can handle up to 3 wheels and two shutters.

Parameters for controlling the wheels are identical from a user interface point of view and so we describe this once.

The shutter can be opened or closed manually by selecting / deselecting **Shutter Open** check box.

The filter wheel has ten positions, each represented in the dialogue by a

coloured circle. If you move the mouse cursor over one of the positions, the name and appropriate value (e.g. wavelength) of that position is displayed in a popup. A left click on one of the positions will move the filter wheel to that position. The name and assigned value of the current position is displayed at the centre of the wheel dialogue.

A right click on one of the positions opens the **Filter** dialogue, in which parameters for that position can be specified.

The name of the Filter represented by the selected position should be entered into the **Name** text box.

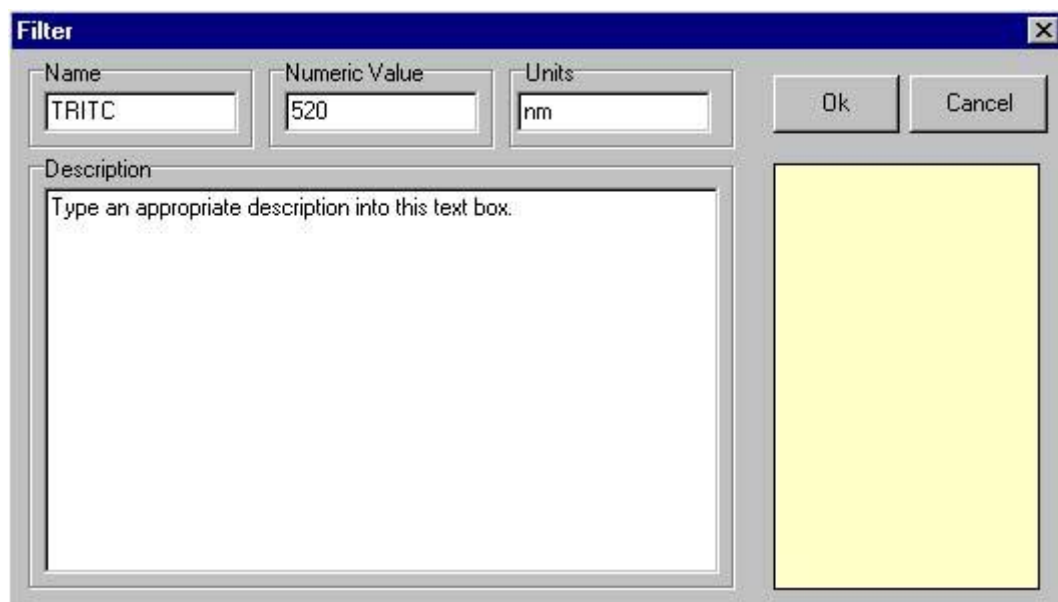

IMPORTANT NOTE: You must give each filter position a *different* name to avoid confusion as the controller uses these names to index the wheel.

The numeric value (i.e. the wavelength) of the filter represented by the selected position should be entered into the **Numeric Value** text box. The Units of the Filter should be entered into the **Units** text box (default is nm).

When moving the mouse over a filter position in the Wheel dialogue the name, numeric value and units assigned to that position will be displayed in a popup. The name, numeric value and units of the currently selected position are displayed at the centre of the Wheel dialogue.

Descriptive text can be associated with each filter position, to display user information about the filter at the selected position. Simply type the required text into the Description text box.

Press **OK** to close the **Filter** dialogue, accepting any changes to the settings.

Press **Cancel** to exit the **Filter** dialogue, ignoring all changes.



Clicking in the lower right hand box of the **Filter** dialogue opens a colour palette.

Selecting a colour from the palette, or defining a custom colour, will display the selected filter position as a circle of that colour in the Wheel dialogue.

A3.4.3 DG4/5 Settings

The DG4/5 excitation source interface is shown left. As indicated this controller handles both 4 and 5 filter versions of the device. You select the 5 position version by checking the DG5 check box. When checked a 5th filter disk will be shown. The

disks represent the filters within the device in the same way as the wheels above.

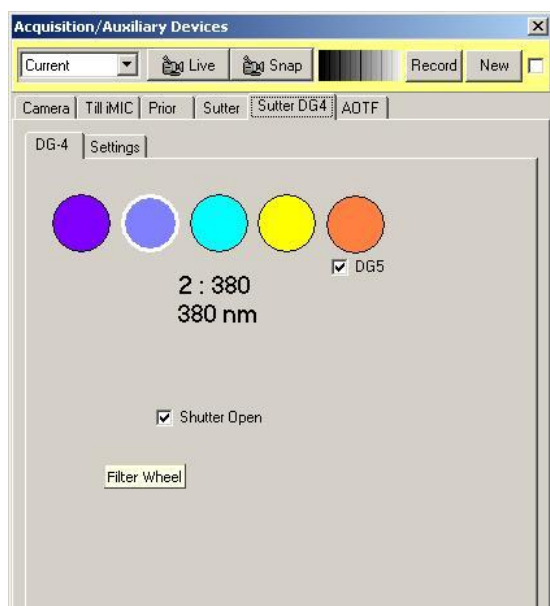

Setting up the disk properties (Name, Value, Units and Color) is the same as described in section A3.6.3 above.

A3.5 The Prior Motorized XYZ Stage

A3.5.1 Start Up of iQ

At the start up of iQ, the panel below is shown if one of the active auxiliary devices is a Prior motorised stage. The user is requested to identify the home position of the stage. This operation need only be carried out at the start of an iQ session or when

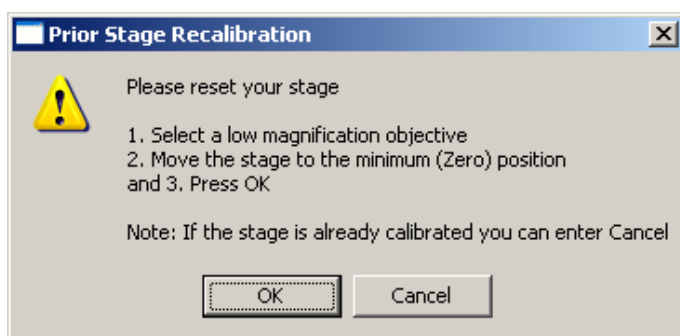

the recognised stage position has been lost and the device needs to be reset.

The home position of the stage corresponds to an (X, Y, Z) position of (0, 0, 0). To zero the stage, move the joystick accordingly. In general, driving the joystick to the top left corner of its travel and clicking on the **OK** button achieves a zero stage position.

If the zero stage position has previously been set, click on the **Cancel** button to continue.

The **Prior** pages can be accessed by pressing the **Device Setup** button on the Acquisition page of your Andor software and clicking on the **Optiscan** tab. These display the current settings of any active devices and also enable the stage to be zeroed without the necessity of exiting the iQ software and starting the session again.

A3.5.2 Optiscan Tab

A3.5.2.1 XY Stage

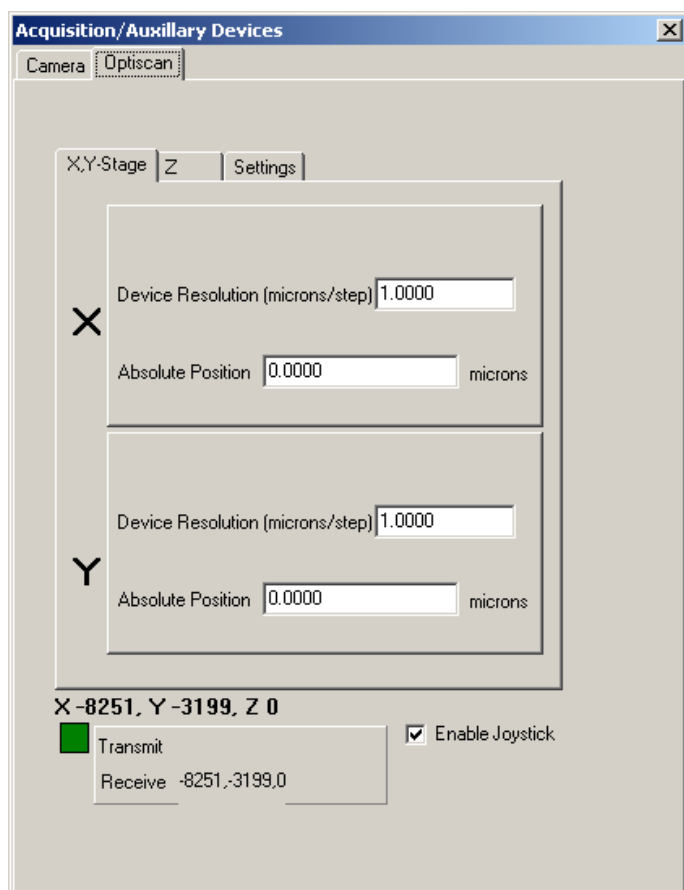

Clicking on the **XY Stage** tab displays the panel shown on the left and enables the **Device Resolution** to be specified for the X and Y axes.

At the bottom of the panel, the current (X, Y, Z) position of the stage is displayed. For the example shown, the (X, Y, Z) stage coordinates are -8251, -3199 and 0, respectively

To allow the stage position to be adjusted manually using a joystick; the **Enable Joystick** checkbox should be ticked.

Commands being written to and received from the COM Port of the PC are also displayed at the bottom of the dialogue. Communication may be monitored by observing the status of the respective **Transmit** and **Receive** messages.

A3.5.2.2 Z

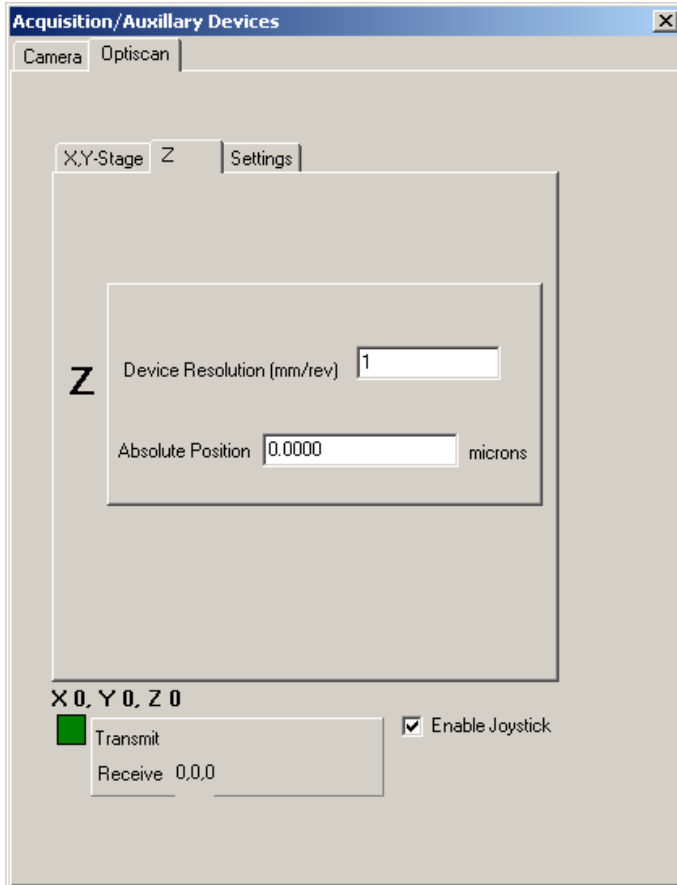

Clicking on the **Z** tab displays the panel shown on the left.

This allows the resolution of the Z motor to be specified.

A3.5.2.3 Settings

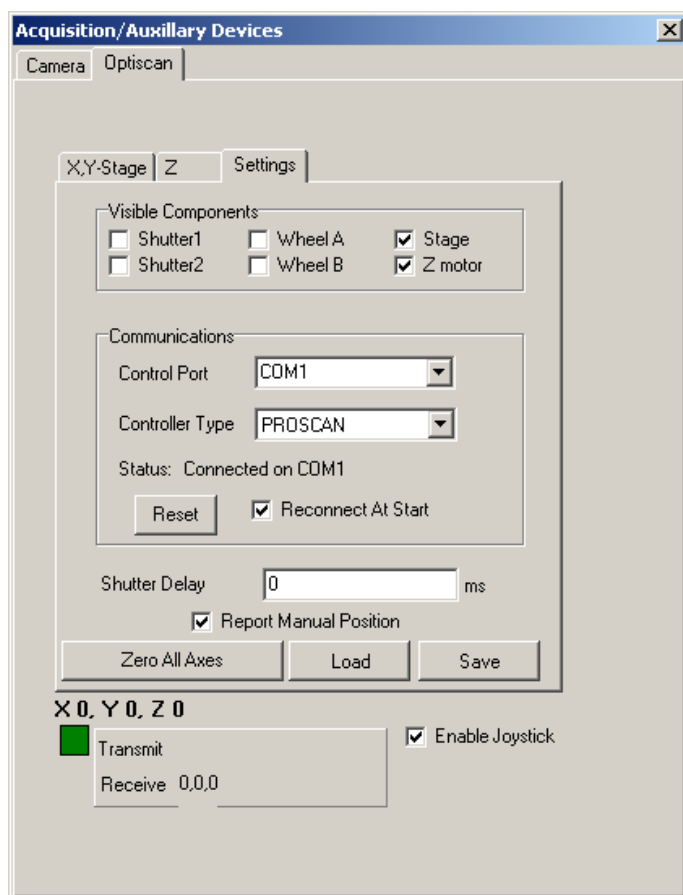

The **Settings** page is used to configure the Prior stage.

For the example shown, the current devices in use are an XY stage and a Z motor. The appropriate checkboxes **Stage** and **Z motor** have been ticked for each device together with the checkbox **Reconnect At Start**. This ensures that the devices are recognised at the start of the next iQ session.

The stage is controlled through one of the serial ports on your computer. From the **Control Port** dropdown list select the port that is being used for the control of the stage. Similarly, the **Controller Type** should be specified. For the example above, a ProScan controller is being used.

To save the current settings to file press the **Save** button. This will open a standard Windows save file dialogue, from which you can specify the filename, drive and directory in which to save the current settings. The settings can be reloaded at a future date by pressing the **Load** button.

The **Zero All Axes** command is used to reset the stage as described previously in **Section A3.5.1** above.

A3.6 Ludl XYZ Stages and Filter Wheel

Andor Technology provides support for Ludl XYZ stages and filter wheel and also for ASI XYZ Stages (**Section A3.10**). These devices have similar configuration and setup, so they have a common setup description for the Device Setup and XYZ stages.

A3.6.1 Device Setup

The Ludl and ASI device setups are accessed from one of the Device Setup buttons located on each window of iQ.

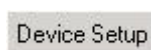

The device profile must first be setup in the Configuration Manager. When the profile is selected the device setup will have a tabs labeled accordingly. In addition to the tabs, the following Options are available at the top and bottom of each Tab:

Current Channel is located at the top of each tab under Device Set up. This allows the user to go live or snap and image with a channel by selecting from the dropdown menu and the record the changes to the channel settings.



Command Status is located at the bottom of each tab. This will signify the cameras or devices operating status. The user can also press the Andor Icon at the bottom of the window to display the About Box

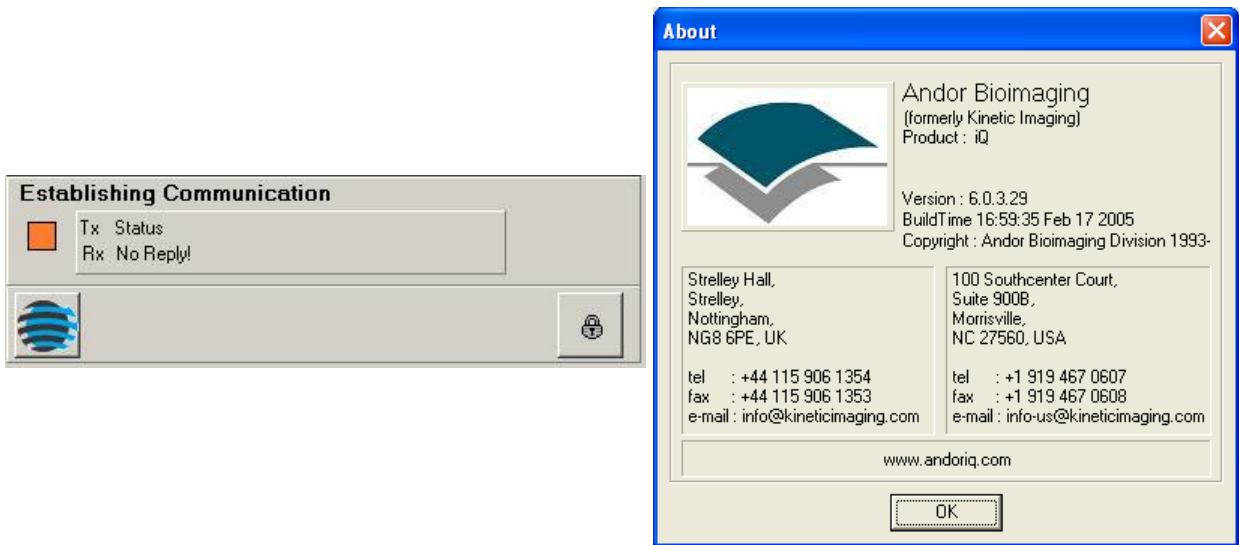

The Lock option is only available to Local Machine Administrators (LMA). Pressing the Lock button gives the LMA a warning message. Press OK to continue or Cancel to exit. Select OK to lock or unlock the settings. This is dependant on which mode the settings are in currently. If the section is grayed out, then it is locked. If the section is not grayed out then it is not locked. Once channels are set up or edited by the LMA, the channel can be locked so no changes can be made by limited users.

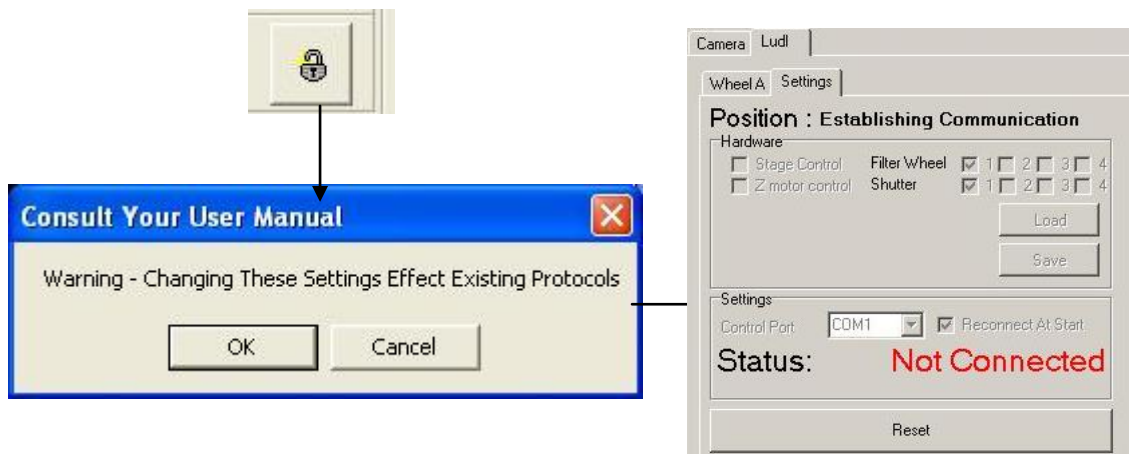

A3.6.2 The Ludl Settings Tab

Current device settings can be stored to disk by pressing the **File Save** button. Settings can be imported using the **File Load** option.

There are four sections included in the Ludl Settings Tab:

- Position
- Hardware
- Settings
- Reset

Position is located at the top of the Settings Tab. This will show the current readout of the stage position.

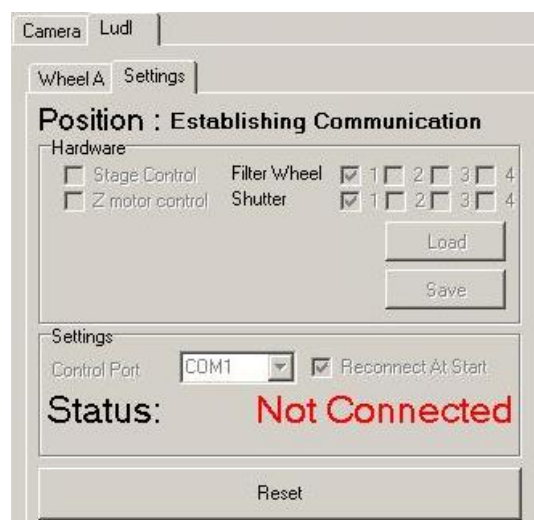

The **Hardware** section is under the Position part of the Settings Tab. Check the box for each option being used. Up to four different filter wheels and shutters can be used along with stage control and Z motor control as shown. For each one selected, a tab is added to the Setup Wizard page. Current device settings can be stored to disk by pressing the **File Save** button. Settings can be imported using the **File Load** option.

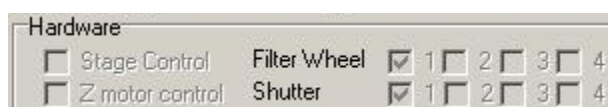

The **Settings** section allows you to select the Control Port from the drop down list. If **Reconnect At Start** is selected the device is automatically recognized when Andor iQ is opened. If **Report Manual Position** is selected the stage coordinates will be displayed in the Communications section. The **Reset** button can be used to revert back to the original settings. Use the **Load** and **Save** buttons to load or save an image.



The **Settings** Section also shows if the device is Connected and its location or if the device is Not Connected.



The **Reset** button can be used to revert back to the original settings.



A3.6.3 The Ludl XY - Stage Tab

Enter the Device Resolution (microns/step) for both X and Y. The Default values are shown in the picture below.

Note: The user must press **Enter** after changing the X value and again after changing the Y value. Verify that the Values entered were set by checking the

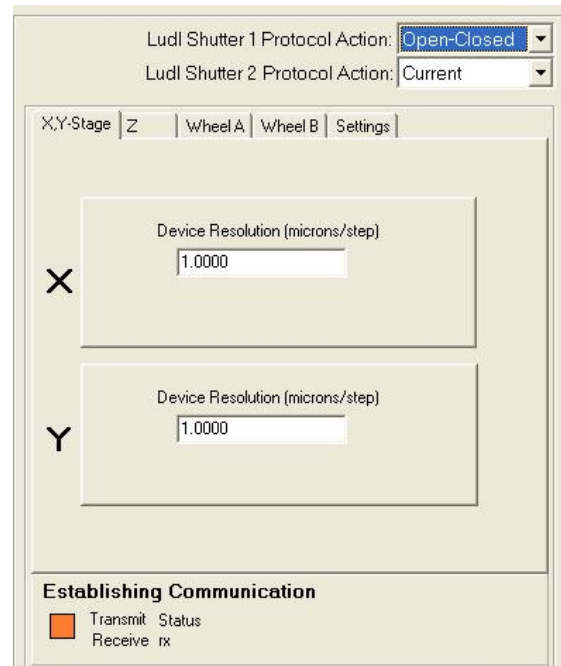

Establishing Communication

This is the section at the bottom of the Window. If the values do not reflect those entered, type the values again.

A3.6.4 The Z Tab

Enter the Device Resolution (microns/step) Z. The Default value is shown in the picture below. The default for open loop Z motor operation on the Ludl is 100 nm per step or 0.1 micron/step. Operating

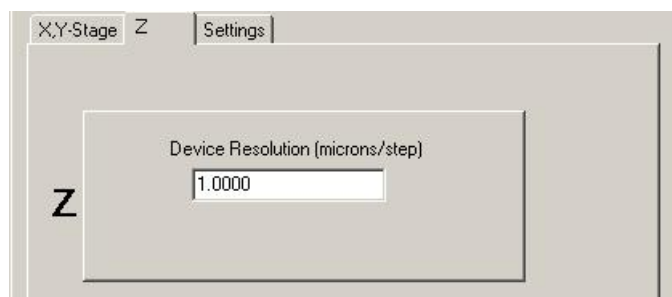

closed loop the motors are commonly set to 50 nm per step or 0.05 micron per step. Closed loop operation uses with a linear encoder gauge to monitor relative position of the stage and objective The linear encoder is attached to the microscope objective turret with a special bracket and the encoder reference plate is attached to a fixed plane on the instrument.

Note: The user must press **Enter** after changing the Z value. Verify that the Value entered was set by checking the **Establishing Communication** Section at the

bottom of the Window. If the value does not reflect that entered, type the value again. You either hit the Enter key on your keyboard or click on the Accept button to ensure this value is set.

A3.6.5 The Ludl Filter Wheel Tabs

You can choose up to four different **Filter Wheels** from the Settings Tab.

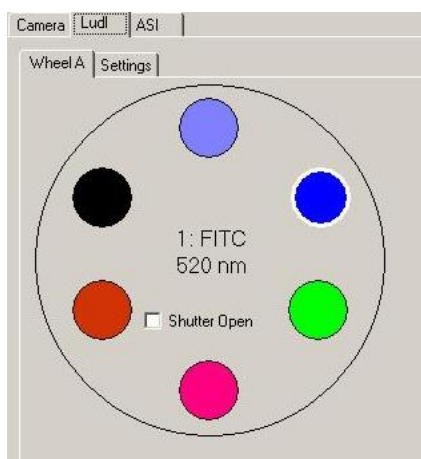

A common configuration is to use one wheel for Excitation and another for Emission, or you can configure a dual excitation wheel configuration in which one Excitation wheel contains ND filters for intensity control and matching between channels. If two or three filter wheels are selected Wheels A, B and C will show individual tabs on the Ludl Interface.

When you right click on any of the circles representing the different filters located in the wheel, a dialogue box will appear. Enter the Name of the filter, the Numeric Value, the Units and a Description (if desired). The Name, Numeric Value, and Units should be written on the filter. If you click in the colored region (area under the OK and Cancel buttons), a color dialogue box will allow you to select the appropriate color to represent the Filter. We recommend you use colors that directly correlate with the excitation and emission colors when setting up Filter Wheel Colors.

IMPORTANT NOTE: You must give each filter position a *different* name to avoid confusion as the controller uses these names to index the wheel.

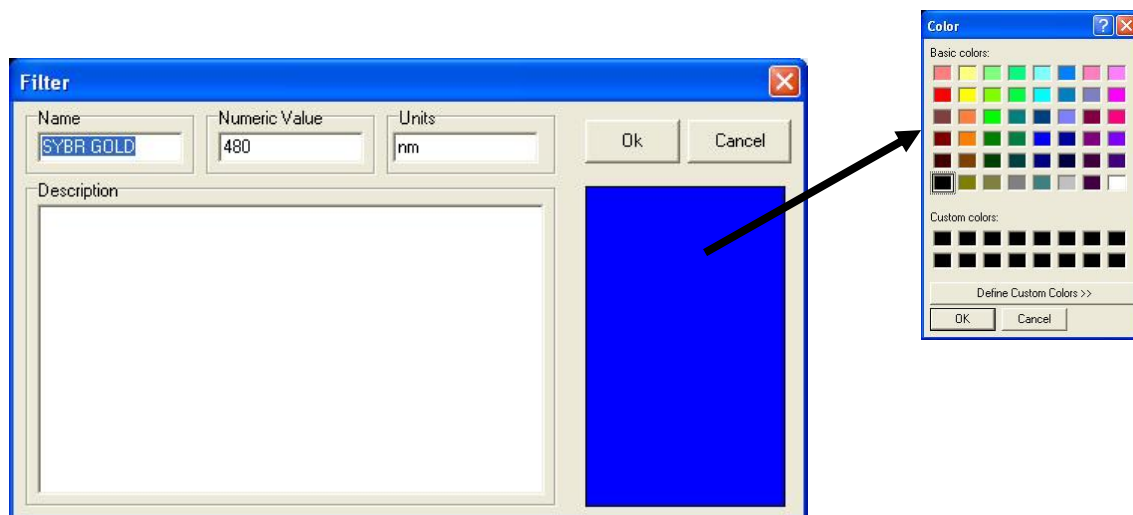

Press **Next** to continue or **Cancel** to exit.

A3.6.6 The Jumper Settings on the Ludl MAC 5000

If using the MAC 500 with Andor iQ you may need to adjust the jumper settings to the following addresses:

Address = 1 (X module)

Address = 2 (Y module)

Address = 6 (Z module)

The MAC 5000 uses a simple jumper scheme to set the address. A two position jumper selects a range from 1-10 or 11-20 and then a ten position jumper selects the actual address.

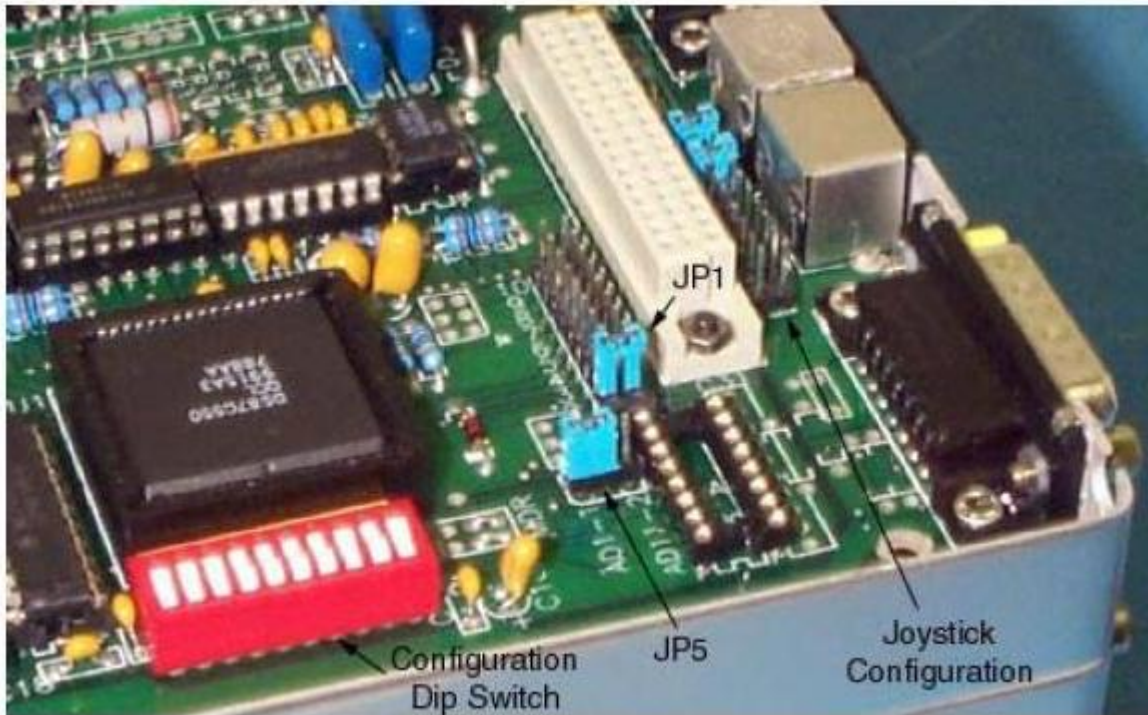

For instance, if the selected range is 1-10, and position 7 on the ten position jumper is selected, the module is set for address 7. Whereas if the selected range is 11-20 the same ten position jumper setting would represent address 17. A module can be set to any address in the allowed range. The high level interface functions, however, assume that certain modules of a certain type are set for specific addresses. See Charts of the DIL connectors right.

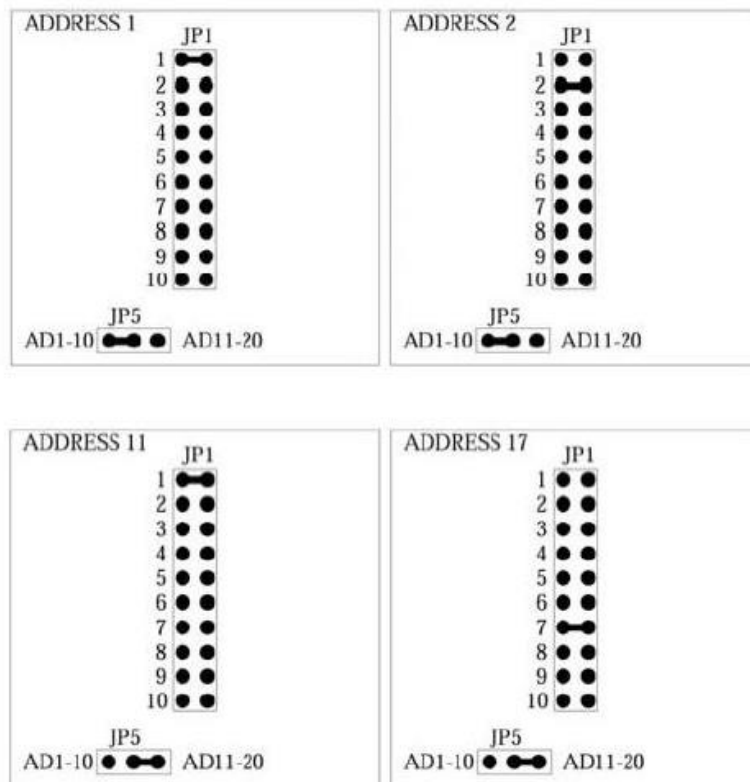

A3.7 ASI XYZ Stages

A3.7.1 The ASI Settings Tab

There are four sections included in the ASI Settings Tab:

- Position
- Hardware
- Communication
- Reset

Position is located at the top of the Settings Tab. This will show the current readout of the stage position.



The **Hardware** section is below Position in the Settings Tab. Check the box for each option being used, stage control and/or Z motor control as shown. For each one selected, a tab is added to the Setup Wizard page. Use the **Load** and **Save** buttons to load or save a setting.

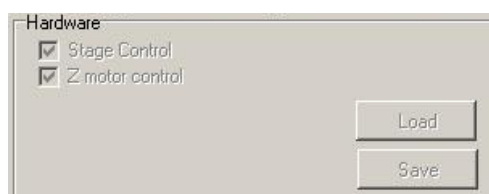

The **Communications** section allows you to select the Control Port from the drop down list. If **Reconnect At Start** is selected the device is automatically recognized when Andor iQ is opened.



The **Status** Section shows if the device is Connected and its location or if the device is Not Connected.

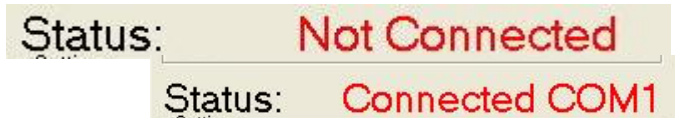

The **Reset** button can be used to revert back to the original settings.



A3.7.2 The ASI XY Tab

Enter the Device Resolution (microns/step) for both X and Y. The Default values are shown in the picture below.

Note: The user must press Enter after changing the X value and again after changing the Y value. Verify that the Values entered were set by checking the Establishing Communication Section at the bottom of the Window. If the values do not reflect those entered, type the values again.

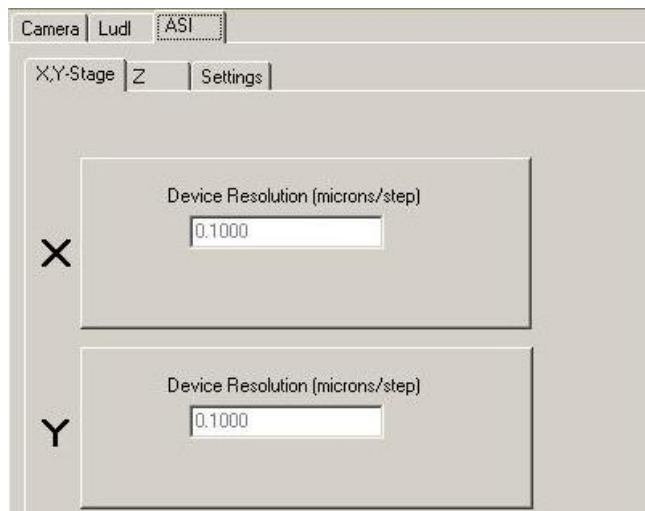

A3.7.3 The ASI Z Tab

Enter the Device Resolution (microns/step) Z. The Default value is shown in the picture below.

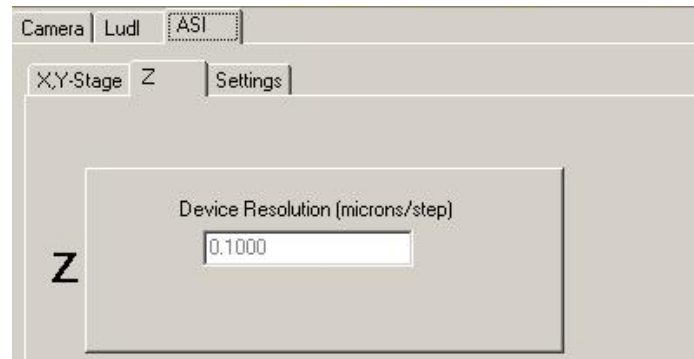

Note: The user must press Enter after changing the Z value. Verify that the Value entered was set by checking the Establishing Communication Section at the bottom of the Window. If the value does not reflect what was entered, type the value again.

A3.8 Thor Labs LEDD1 controller

Andor iQ can utilise the Thor Las LEDD1 LED light source controller via TTL I/O from the Precision Control Unit (PCU), Generic Shutter device or the Kinetic Trigger device. The LEDD1 is especially useful to control a white LED for rapid switching of bright field illumination. The compatible LEDs are available housed in collimating housing with flanges suitable for all major microscope models as shown below. The device has manual control as shown – in CW mode the LED will be on and intensity controlled by knob rotation; in Pulse mode the LED accepts TTL or analogue input. The LEDD1 has a single input which can accept 0-5Volts DC and has a rise and fall time of < 50 μ s. If driven from TTL then the LED device is on or off.



A3.8.1 TTL Connections and iQ control

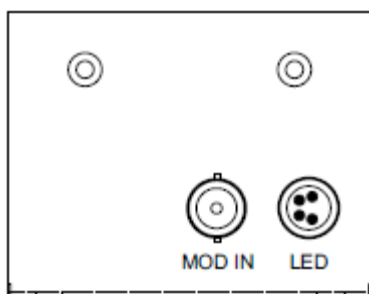

In order to control it for bright field imaging with FLZ you connect a selected TTL line on the PCU to the MOD IN input shown to the left. Note the LED illuminator connects to the LED connector.

Andor iQ USER GUIDE

If you are using FLZ then the TTL output DO4 is used for Bright Field shutter control, so use this line. You can specify the exposure time (on time for the LED) in increments of 0.1 ms in FLZ or in 1ms increments in Time Lapse. The FLZ Burst and Bright Field control is shown in the dialog below.

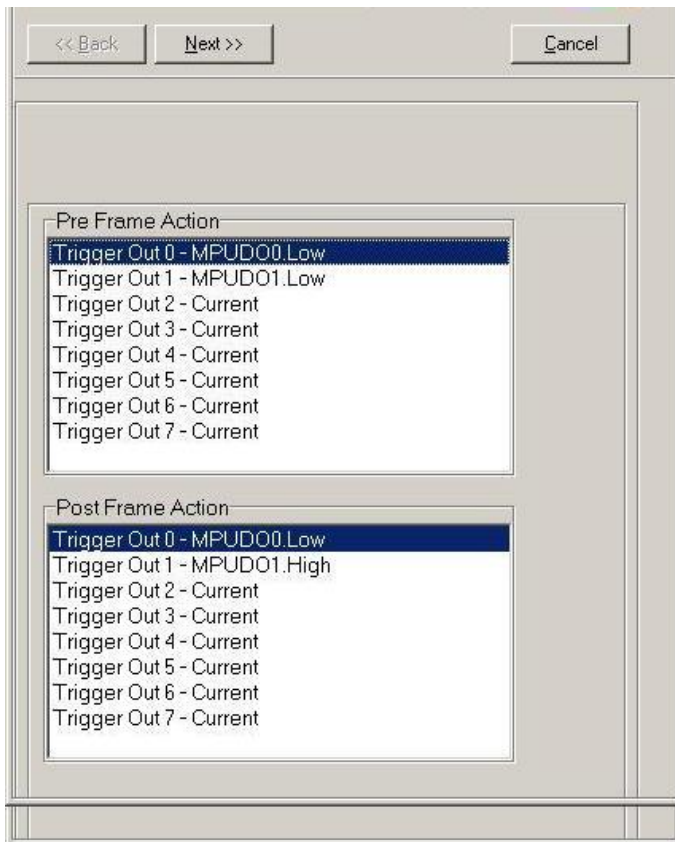
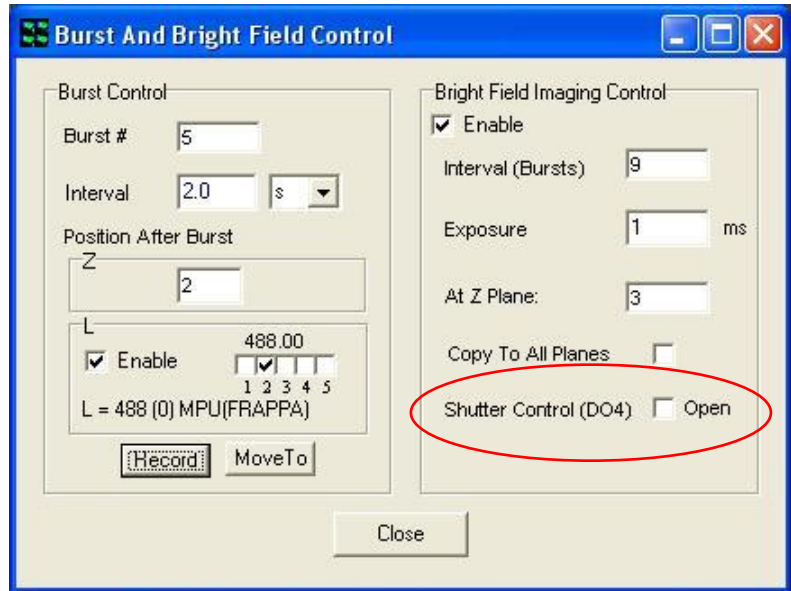

If you are controlling the TTL line for the Trigger controller then you will setup Pre and Post frame actions on the chosen line.

See left for example of using the Trigger device in Time Lapse on TTL Output DO1.

A3.8.2 Note on optimizing transmitted light image quality:

When using LEDD1 (and other LEDs for transmitted light imaging) with the CSU laser dual spinning disk confocal you may be subject to scan line artefacts in resulting images. In order to minimize this effect you can introduce a neutral density filter (NDF) into the transmitted light path, so that longer integration times can be used without saturating the camera.

A3.9 CoolLED – PE2 and PE100 LED illuminators



Andor iQ controls the CoolLED PreciExcite (PE2 and PE100) LED. The PE devices (PE2 illustrated here) are available from Andor Technology and integrate with Andor systems and cameras. PE2 is available with 2, 3 or 4 LED wavelengths. The LED array modules (LAMs) and can be switched by the user for increased flexibility.

A3.9.1 Using PE2 with Andor iQ

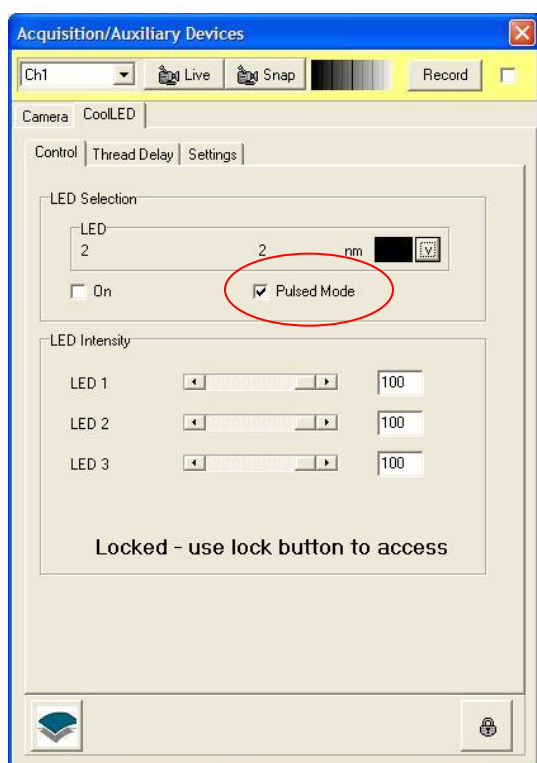

You control the CoolLED PreciExcite LED (PE2) from iQ via a USB interface (which is mapped to a COM port – usually Port 9). When you have built a Configuration using the PE2 for the first time, you must Use the Device Setup panel to initialize the COM port and GUI settings for wavelengths and colors as shown in Figure 2.

Figure 2 Shows the Andor iQ GUI for CoolLED PE2 control. Pulse mode checkbox is circled in red. Manual control is performed from the GUI shown, while setup of the COM Port is done from the Settings tab.

You can use either a standard shutter operation or a special feature of the PE2 unit

called “Pulse mode”. These modes are mutually exclusive and are recorded with the Channel. See notes below regarding potential setup issues..

Standard Shutter mode - set the Shutter to “Open-Close” in your iQ Channel. All commands and actions are coordinated by iQ via the USB interface.

This mode of operation and Pulse mode are mutually exclusive and if you have the Fire connected to the PE2 panel the system function will be compromised. So make sure you have no cable connection to Fire.

- Note that when used with Luca R, a 60 ms Shutter transition delay setting will be required in the iQ PE2 controller Settings tab.
- Multi-Channel Operation is identical to single channel in this respect.

Pulsed mode - set the Shutter to “Open” in the iQ Channel and the Fire Pulse operation will gate the LED on and off.

- Make sure the Fire pulse cable is connected to the PE2 rear panel. You will see the PE2 LEDs light up as the camera exposes to capture a frame.
- Luca R can produce an erratic display of flashes, indicating that the Fire signal is reset when frames are demanded, so you may observe more than one flash per frame.

Pulse mode operation ensures the LEDs are on only during camera exposure and therefore minimizes specimen exposure, rather like the Active Blanking Feature we use in the laser combiner.

In **Pulse-mode** the PE2 is configured to accept TTL pulses from the camera Fire signal to gate the LEDs on and off via input pin 9 (and pin 1 Gnd) of its 15 way sub-D connector on the rear port of the device. A special cable is available from Andor to couple SMB to D15 and if required to Direct TTL control for maximum speed. Pinout for the TTL cabling solution is shown in the next section.

Table 3.12.1 Connections for the iQ-TTL+Pulse mode cable for the CooledLED are as follows.

Parallel TTL Port

The precisExcite is fitted with a 15 way D-type socket to allow external TTL signals or switch contacts to control the switching on and off of the LED arrays.

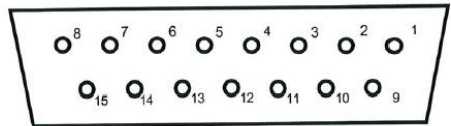

Front View of D-type Socket

TTL Drive

Channel 1 TTL Input	Pin 10 +ve	Pin 3 Gnd
Channel 2 TTL Input	Pin 11 +ve	Pin 4 Gnd
Channel 3 TTL Input	Pin 12 +ve	Pin 5 Gnd
Channel 4 TTL Input	Pin 13 +ve	Pin 6 Gnd
Trigger TTL Input	Pin 9 +ve	Pin 2 Gnd
Sync TTL Output	Pin 15 +ve	Pin 7 Gnd
Pin 1, 8	Gnd	

Switch Contact Drive

Channel 1 Switch Input	Pin 10	Pin 14 (Internal 5V)
Channel 2 Switch Input	Pin 11	Pin 14
Channel 3 Switch Input	Pin 12	Pin 14
Channel 4 Switch Input	Pin 13	Pin 14
Pin 1, 8	Gnd	

Connecting a switch contacts between the switch input pin and the internal 5V pin14 will turn on that channel when the switch is closed

<u>Camera</u>	<u>TTL Source</u>	<u>TTL Sync</u>	<u>CooledLED 15 way</u>
Fire SMB			9 (Trigger)
Fire SMB			2 (Gnd)
	TTL 1		10 Channel 1
	1 Gnd		3 Gnd
	TTL 2		11 Channel 2
	1 Gnd		4 Gnd
	TTL 3		12 Channel 3
	1 Gnd		5 Gnd
	TTL 4		13 Channel 4
	1 Gnd		6 Gnd
		Sync out	15 Sync TTL
		Gnd	7 Gnd

A3.10 Andor Differential Spinning Disk (DSD)

The Andor DSD scanner enables confocal imaging, combining the advantages of a spinning disk with structured illumination. iQ controls allow the DSD to switch internal filter wheels for excitation and emission, internal mask for image calibration and spinning disk between its high sectioning and high signal positions. The interface to the DSD is via USB and the actions required for calibration and background corrections are handled automatically and so are not covered here, but in Chapter 3 of the user guide. The Andor DSD is shown below with its replaceable filter turret. In normal operation the cover will be in place and the turret installed. Details of filter turret replacement can be found in the iQ Wizards menu.



User access to DSD turret changes is especially convenient in the Andor design, and can be performed while the DSD remains attached to the microscope as shown.

A3.10.1 USB Connections and iQ control

In order to control the DSD it is necessary to have the unit powered and a USB connection made to your computer. The screen shot over the page shows the DSD Settings tab which is accessed via the Device Setup dialog. In the settings tab you select Device 1 or if you have no device, but want to explore the interface you can select Demo as shown. You can also specify which Turret is currently selected.

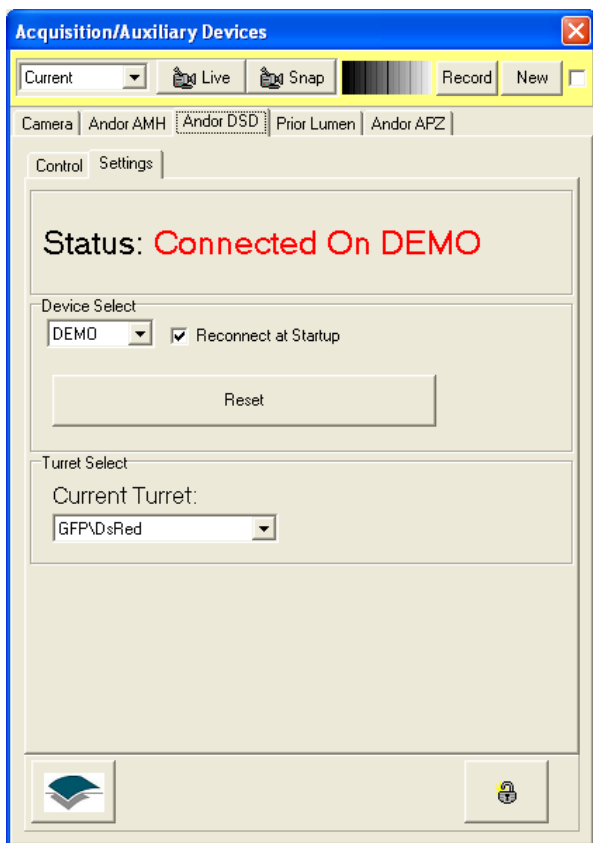

Once the device is connected you will have control via its GUI for manual control. The settings can be stored within iQ Channels to ensure they are re-used in Protocols for multi-dimensional acquisition. The GUI controls are shown below.

Note there are only two primary controls. The first is the combo-box, which selects the position of the internal filter wheels. The figure below shows the blue excitation filter (center 444 nm for GFP) selected and an equivalent green Emission filter will also be selected.

Some systems have multi-band excitation filters inside the DSD, so there will only be a need to switch this control if a different set of fluorophores is to be used.

Some systems have multi-band excitation

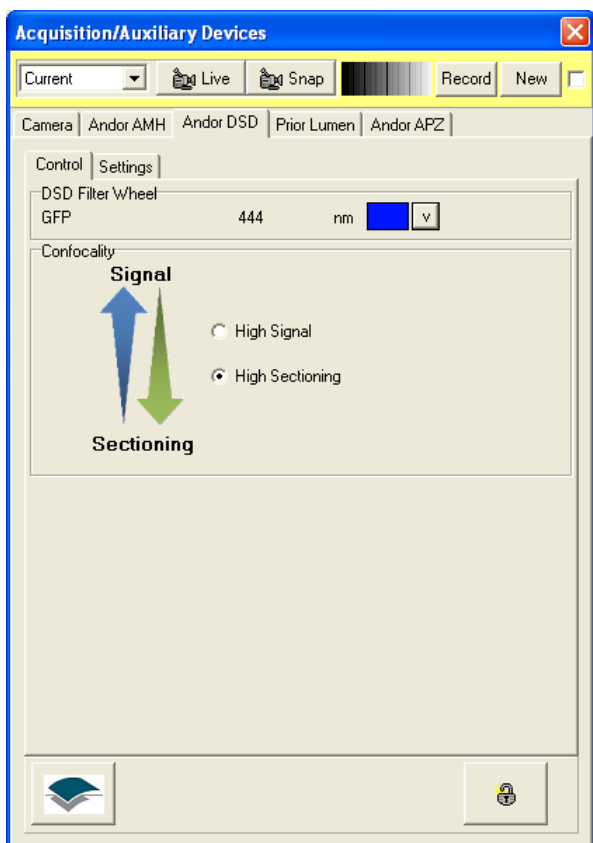

Andor uses light sources (see next section) with excitation filter wheels faster switching than the DSD unit for rapid multi-wavelength imaging. In that case then the multi-band DSD filters will be held in place, while the excitation wavelength is switched for faster operation.

The second control on the DSD interface allows you to choose between High Signal and High Sectioning. The spinning disk used in the DSD utilizes a structured illumination pattern (SIP), combined with

image processing, to achieve optical sectioning. This contrast of Signal to Sectioning defines which pattern will be used during in imaging. The lower frequency provides more signal since it has a broader axial (Z) response, while the higher frequency SIP provides stronger sectioning or narrower axial response. So selecting the relevant control on the GUI moves the disk to ensure the correct SIP is used to modulate the specimen illumination.

A3.11 Metal Halide Source (Prior LumenPro)

Andor iQ controls a range of light sources and here we focus on the metal halide variety. A serial interface is used to control both Prior LumenPro 200, which contains

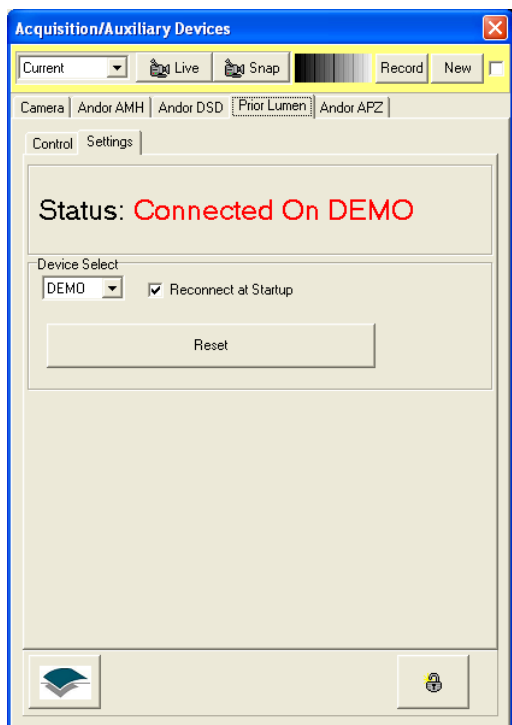

a 200 Watt DC stabilized arc lamp, 6 position filter wheel and pseudo-continuous shutter (0 - 100%; 1% increment). The GUI for this device is shown below, where its demo mode capability is shown. If you have a real device connected you must specify an available Device ID in the drop down list named Device Select. A USB connection is required.

The primary controls for the light source are shown on the Control tab of the Device Setup dialog.

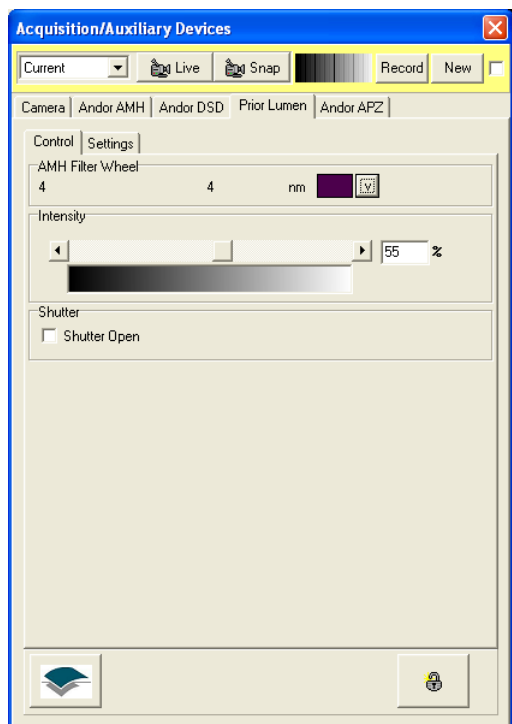

The combo-box is similar to the DSD filter selection, but in this case only controls a single filter wheel which has a switching time of 60 ms between adjacent positions. A right mouse action on the combo box allows you to edit the current filter information, such as excitation wavelength.

While the slider (the continuous grey-scale annotation) allows control of the output intensity setting with 1% increments (shown at 55% here). The device Shutter checkbox switches the continuous shutter between the slider setting and zero output.

A3.12 Andor PZT-X00 Piezo Stage control



The Andor PZT-X00 Z stage can be supplied in ranges 100, 200, 250 and 500 nm. The 250 and 500 stages are required for multi-well or micro plate operation, having a large aperture to accept well-plate holder accessories.

The PZT-100 (shown) and 200 nm stages are suitable for 35 mm Petri and MatTek dishes as well as 3"x1" slides.

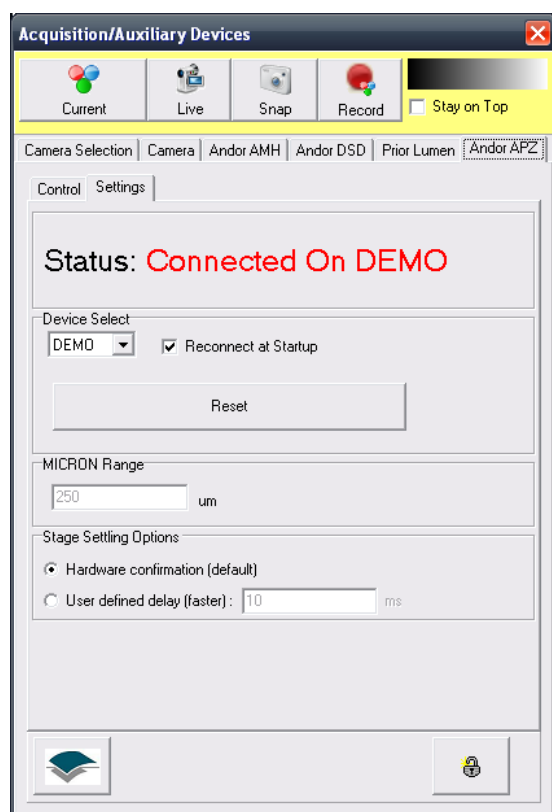

Control of the PZT-X00 stages are via a serial RS232 interface and hence in the Device Setup Settings tab you will need to specify the appropriate active COM port number for connection. Once the connection is confirmed the device will show its status as seen left.

If the padlock at the bottom right of the dialog is clicked, a warning will be shown that settings may affect device performance. Accept the warning by clicking OK and then you will be able to set the Piezo Z range in the "MICRON Range" text box. This value is then used to scale the data set to the Piezo

device controller and manage the internal Piezo Z values used for scanning and focus control.

The stage settling options are used to control the communication between iQ and the

Piezo. These options define how long iQ should wait, after sending a move command to the Piezo, before acknowledging the move. Once iQ has acknowledged the move it can update the user interface to display the new position and, during a protocol, iQ can go to the next step of the protocol i.e. sending a command to another device.

By default "Hardware confirmation" mode is selected. In this mode iQ will wait for the Piezo to confirm it has finished moving to acknowledge the move.

In "User defined delay" you have the opportunity to tell iQ exactly how long it will wait in milliseconds before acknowledging the move. This mode allows iQ to begin other tasks it has to perform (such as sending commands to other devices) before the piezo has completely finished moving. This allows for faster protocol acquisitions. On the other hand, iQ loses synchronisation with the Piezo, i.e. iQ doesn't know when the Piezo has physically finished moving.

As a result it is possible that images are acquired before the Piezo is completely stabilised and thus you can find some images are either blurry or display the wrong Z position. A usual side effect of using a short delay is the first frame of every stack to

be acquired too early while all other frames are fine. This is due to the longer distance the device has to travel between the end of a Z stack and the beginning of the following one. Adjust the value as required.

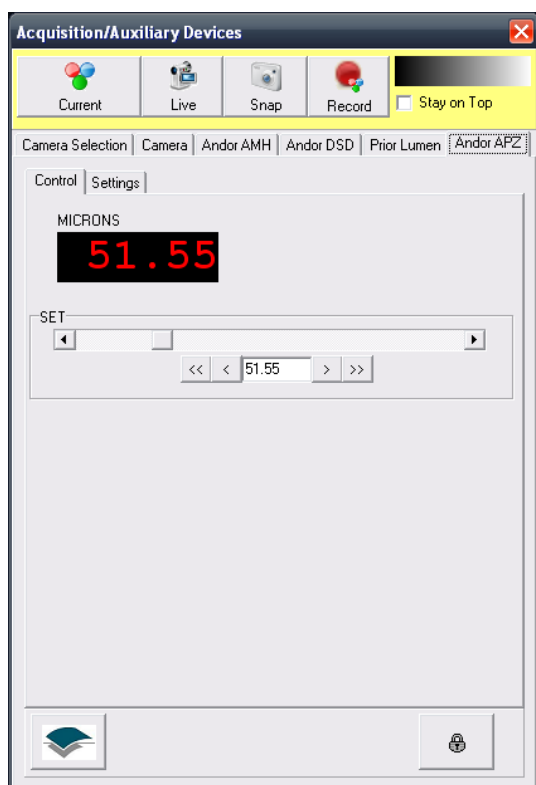

Control is very simple and consists of a slider which sets the Piezo value in the configured range and is used during scan setup and manual operations. The control dialog is shown below. The readout shows the current setting and the buttons left and right of the text box below the slider move the Piezo stage by increments of ± 0.1 and $\pm 0.5 \mu\text{m}$ respectively.

A3.13 Generic TTL control from Andor iQ

The hardware interface required for the **Generic Shutter** (GS) adapter is flexible according to the control requirements. When you create and load a configuration with GS you select which interface to use as shown below. GS offers “8 Line TTL Shutter” using a PCI-DIO24 card (Appendix 3e), Nikon LUSU and Uniblitz shutters via RS232 as well as 8 Line TTL control via Parallel Port (LPT) all on a Windows PC.

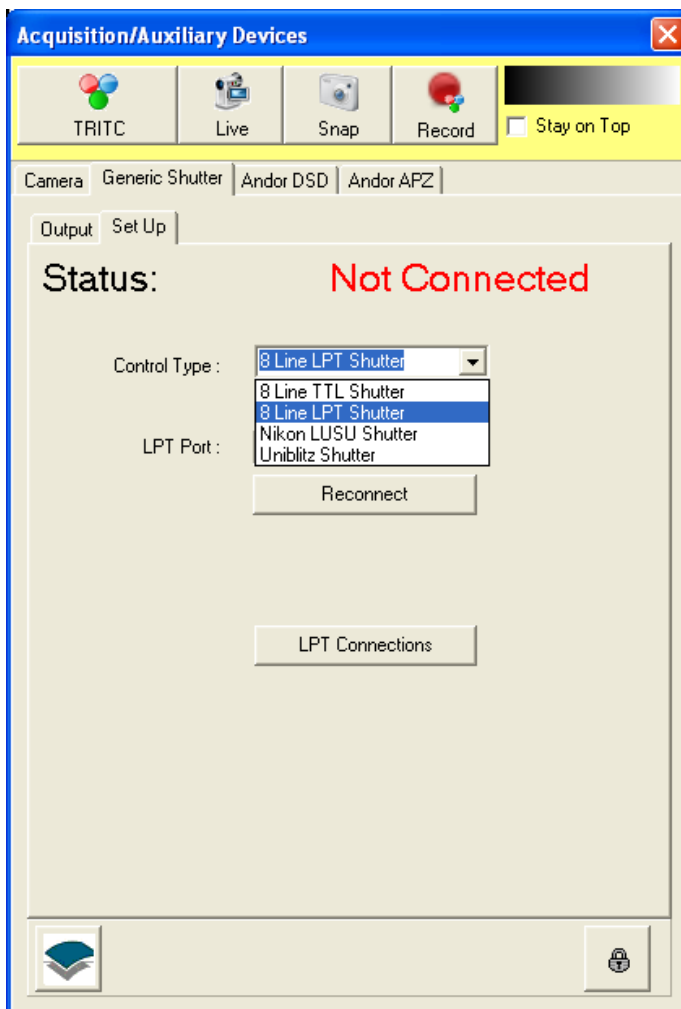

The LPT parallel port has 8 TTL output lines for control of hardware including shutters and other hardware such as Lumencor light engine, perfusion control and so on. The LPT1 interface is standard on Andor Imaging workstations (e.g. Dell T3500) but has been phased out by some manufacturers. Fortunately, you can readily obtain PCI and PCIe to Parallel port (IEEE-1284) interface cards at a very low cost. Examples below have been tested at Andor and showed robust behavior.

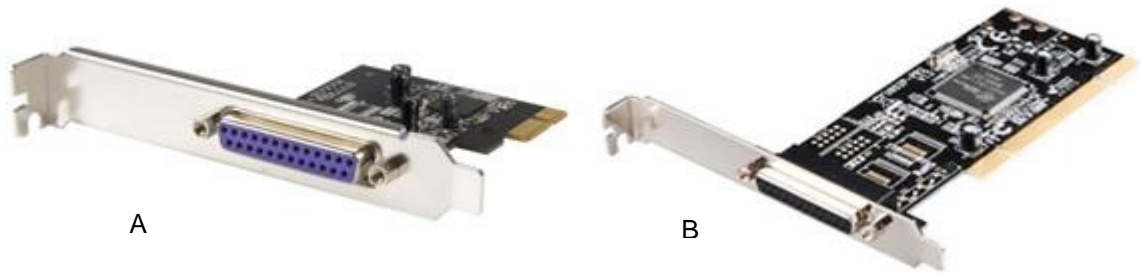

A: StarTech PEX1P PCIe Parallel Adapter Card - 1 Port, SPP, EPP, ECP

B: Ultra U12-40736 PCI Parallel Adapter Card - 1 Port, EPP/ECP, IEEE 1284 Bi-Directional, 1.5Mbps

1. If you are using an Andor workstation or other PC with motherboard parallel port then you can simply connect to the port in hardware and software and then start using it. See step 6 for more details on use.
2. If you use a PCI or PCIe card, make sure the correct LPT driver is installed and the LPT port shows in the Windows Device Manager without errors. In this case you will also need to note the address of the card and set up the Devices.ini file in iQ's folder in the Application data path. You can check the card status by looking in the Device Manager at the COM and LPT section as shown below. This shows the Motherboard device (LPT1) and a PCI card.

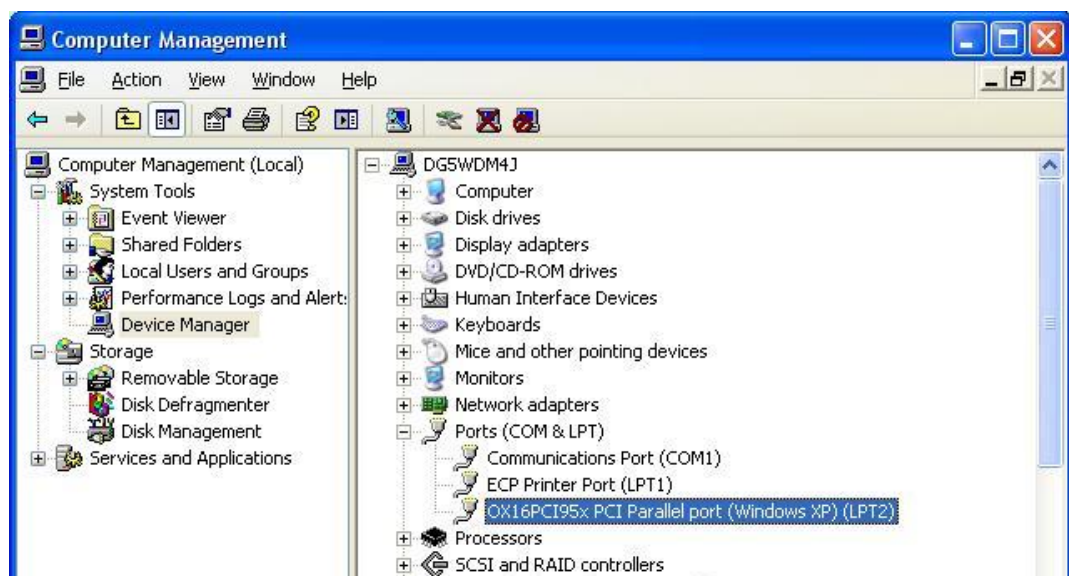

To check the PCI card address, select the card entry with left mouse click and then right click for a pop-up menu and then choose Properties.

3. In the Properties dialog check the Resources tab where the IO hex address is listed as shown. This value will depend on the exact setup of your system.

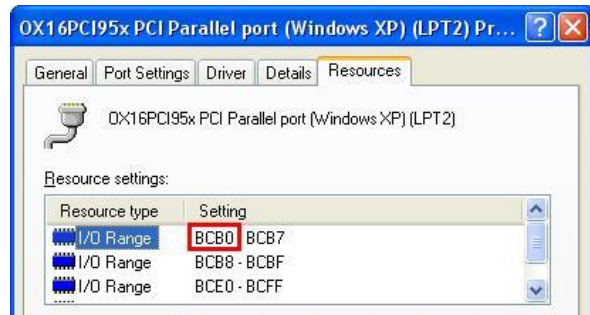

4. You can use Windows Calculator to convert the hex address to decimal, which is the format iQ uses. So enter the number (BCB0 here) and enter it into the Calculator with the calculator format set to **Hex** as shown. Then switch the Calculator to **Decimal** (Dec) as shown - the result is 48304 in this case and this value will need to be entered into the Devices.ini file as shown in step 6 below.

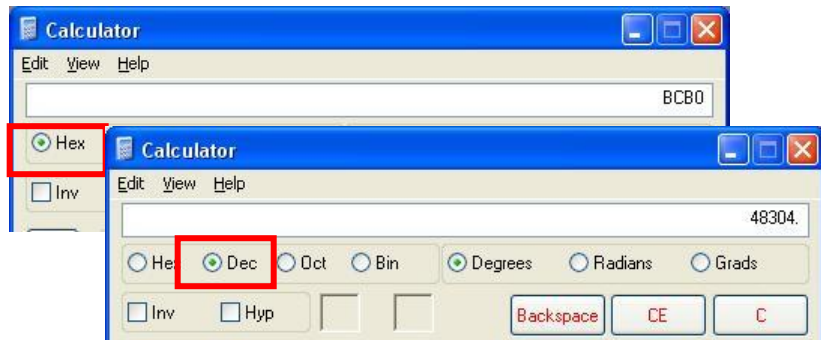

5. Before you can edit the Devices.ini file as shown in step 6 below, you have to create an iQ Configuration containing the Generic Shutter adapter. Then Open iQ, select the Configuration and continue to initialize all devices. When you next Close iQ, it will create the necessary entry in Devices.ini file for you edit. Then proceed to edit Devices.ini.

6. Enter the value 48304 for the board above (or your equivalent value from step 6) into the Devices.ini file (you will find this in the folder: <C:\Documents and Settings\All Users\Application Data\Kinetic Imaging\Common>. Open the file with Notepad, find the entry shown below, add the entry and then save the file.



6. Now you have installed the Parallel port card and assigned its address, iQ will be able to write whatever digital patterns you wish to assign to the TTL outputs of the device.

7. As shown on the left you can edit the names and actions of the TT

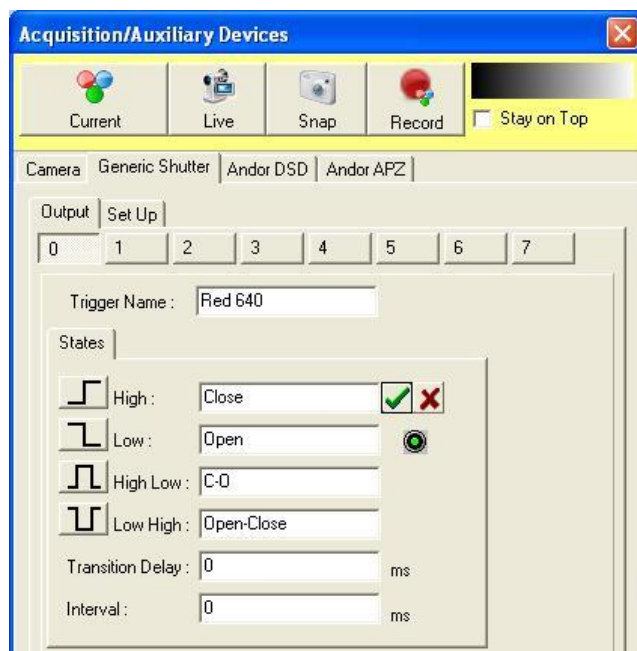

A3.14 Physik Instrumente USB stage controllers

Installing the Physik Instrumente driver

Use of Physik Instrumente (PI) USB stages in iQ requires that you install the PIMikroMove software; then update the PATH environment variable in Windows to allow iQ to use PI's driver.

If this is not set up correctly; then on attempting to use a PI USB stage controller in iQ you will see the following error:

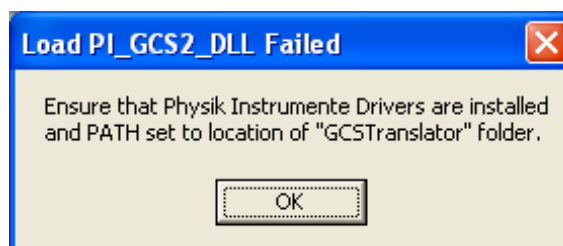

Firstly, install PIMikroMove from the Physik Instrumente CD supplied with the system. If this CD is lost; please contact [Andor Support](#).

During the installation from the CD, simply choose "Typical" setup.

Secondly, the directory containing Physik Instrumente's driver files needs to be added to the Windows PATH environment variable.

The directory that needs to be added to PATH is:

C:\Program Files\PI\C-867\PI_GCS2_DLL

...where **C-867** is the model code of the controller and may differ on your system.

If you are unsure how to update the PATH variable in Windows, please refer to your IT administrator or Andor Support.

Using the PI USB XY and Z devices in iQ

To control the Physik Instrumente XY and Z controller in iQ; Create or Edit a configuration using ConfigurationManager, and include “Physik Instrumente PXY USB Device” and/or “Physik Instrumente PZ USB Device”.

If you have both XY and Z control through a single PI controller unit; please include both the PXY and PZ device options.

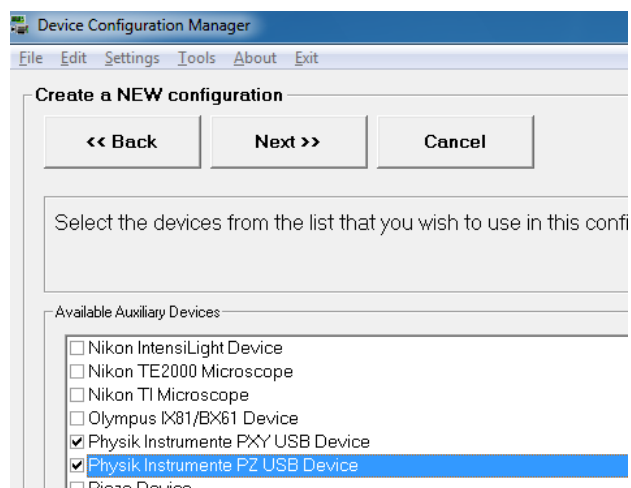

When you launch iQ, you will see device tabs called “PI XY” or “PI Z”. To connect to the controller, simply go to the “Settings” tab and set the “Device Select” option to the controller (you will see both the model and serial number of your controller listed).

Other options are “NONE” (not connected); or “Demo” to enable simulated controls without having a PI controller device connected.

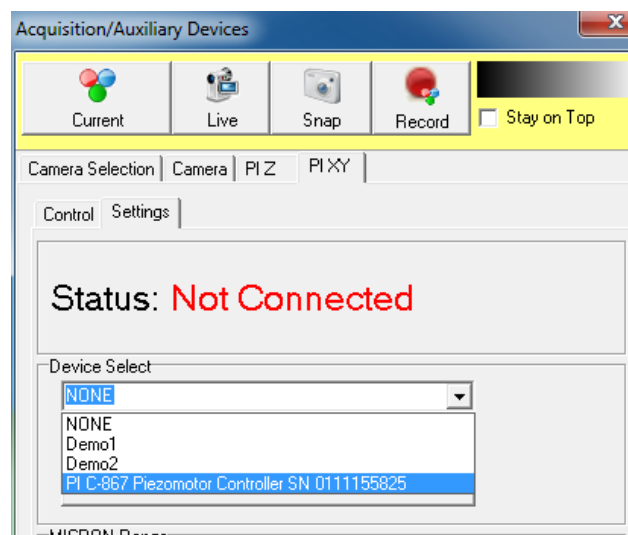

Notes on the usage of the PI XY/Z devices:

- Supported models of Physik Instrumente XY stages require “stage registration” every time iQ is started up. Please refer to **Section 3.2** of this document for details on the stage registration process.
- **Section 4.3** of this document describes how to create and edit XY scans and Z stacks, to use the XY axes in a protocol. See also appendices **A5.2** and **A5.3** for “How To” guides to creating a Multi Field scan and a Z stack.

A3.15 Andor Laser Combiner (ALC)

Basic Settings

As with all devices, a Configuration must be created with Configuration Manager and the Andor Laser Combiner driver selected. In iQ software, the Device Setup window will show a new tab labelled AOTF. The Settings tab allows the device to be configured. Typical settings are shown below:

Note: as with all device control in iQ, the Device Setup window allows manual control of devices. In order to use the device in a Protocol, i.e. in an automated manner, Channels must be created. The Channel will be essential to define the behaviour of shutters for example, but once created, the Device Setup window will allow changes, such as intensity and laser wavelength, to be quickly stored to the Channel by using the Record button.

The interface can be unlocked by clicking the padlock icon.

The reset button can be used to perform a full software reset of the device and is equivalent to restarting the software.

The **Multi Position Unit** (sometimes also called Multi Position Device or MPD) checkbox should be selected if the ALC is fitted with this (e.g. most FRAPPA and TIRF systems). If present, this allows the lasers to be switched to another fibre and a maximum of three fibres can be fitted. If selected, an additional **MPU** option will be available in the main ALC tab, shown over.

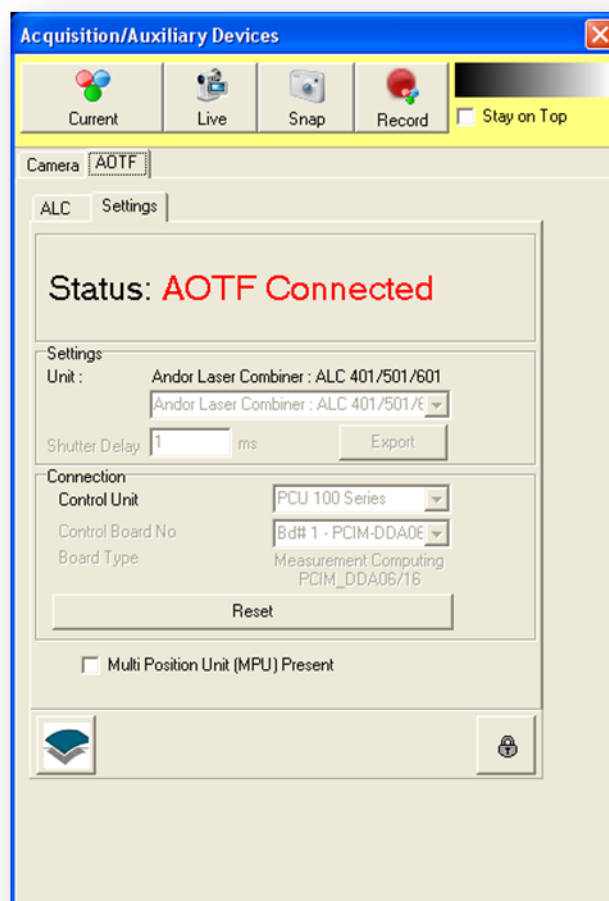

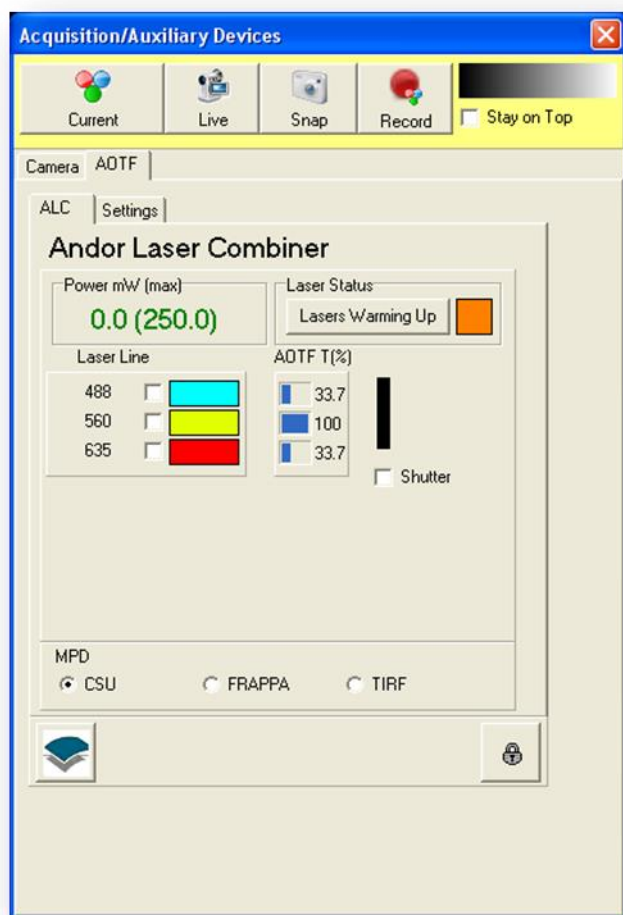

In the main ALC tab, shown to the left, the lasers available are shown (488, 560 and 635 in this example). Each laser has its own checkbox and there is a **Shutter** checkbox that applies to all the lasers. In each case, this checkbox will toggle the AOTF to allow that laser, or all lasers in the case of the **Shutter** checkbox, to pass. In this sense, they can be thought of as virtual shutters. (They do not affect the lasers themselves, only the behaviour of the AOTF.)

Note: if Active Blanking is enabled on the PCU (Precision Control Unit, which houses the AOTF

controller and has various inputs and outputs), it will not be possible to send laser light out of the ALC unless the system is actively imaging, e.g. Live, Snap, FRAPPA or running a Protocol. Active Blanking can be thought of as the hardware equivalent of the **Shutter** checkbox and allows the synchronisation of the AOTF, hence laser light, with other devices, notably cameras fitted with trigger outputs (e.g. all Andor cameras) and the Andor FRAPPA device.

The **MPU** option at the bottom allows the laser to be sent to different fibres (if fitted), hence different devices.

The **intensity** of each laser can be seen under the **AOTF T(%)** beside each laser and is represented with a blue bar. Clicking any of these will open a new window, shown over.

The **Power mW (max)** value represents the approximate total laser power entering the fibre and is intended to prevent damage to the fibre on systems with many high power lasers. It has very little correlation with laser power on the sample, as this will depend on many factors between the output of the ALC and the sample that the software cannot be aware of.

Note: the maximum output power is set to **250 mW by default**. Please contact customer support if you need a more powerful setup.

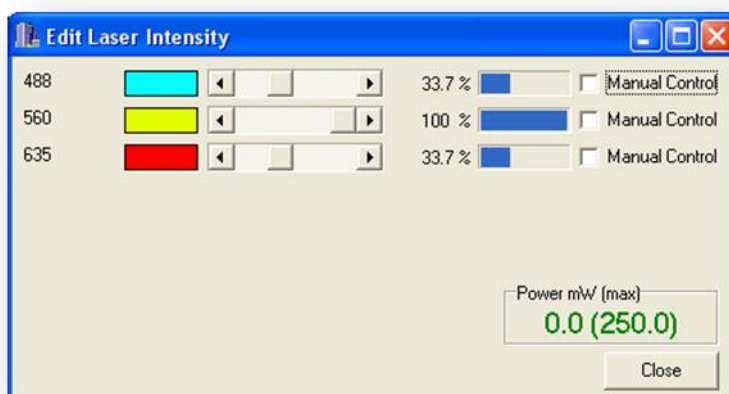

Each slider will change the intensity of the laser by adjusting the AOTF. The **Manual Control** checkbox allows the user to override the Channel settings and control the laser intensity manually during a Protocol. This allows on-the-fly intensity adjustments while executing a Protocol or use of a laser that is not in the Channels

of the Protocol. Enabling **Manual Control** will change the colour of the intensity in the main AOTF window to red to show that it is no longer under control of the Channel. This is shown here for the 488 laser.

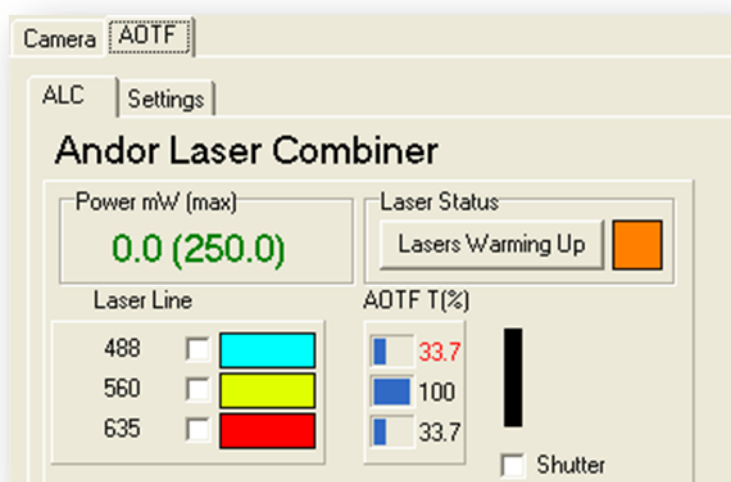

Advanced Settings

Additional information about the lasers in the ALC and some advanced control can be seen when clicking the button under **Laser Status** in the main ALC tab. This is labelled as **Lasers Warming Up** in the below screenshot. This will change to **Lasers Ready** and the orange square will turn green when the lasers have reached operating levels. For most lasers, this will take less than five minutes after the software has successfully connected to the ALC.



Once clicked, a new window will appear as follows:

We can see useful information here, such as the **Serial Number** of the ALC, whether or not **Active Blanking** or an **MPU** (sometimes also called MPD) is present.

We can also see that the **Interlock** is OK and that the **Shutter** is open. This is a physical shutter activated by the interlock and, if closed, would prevent all laser light from entering the fibre. When compatible software is not running, this shutter will be closed.

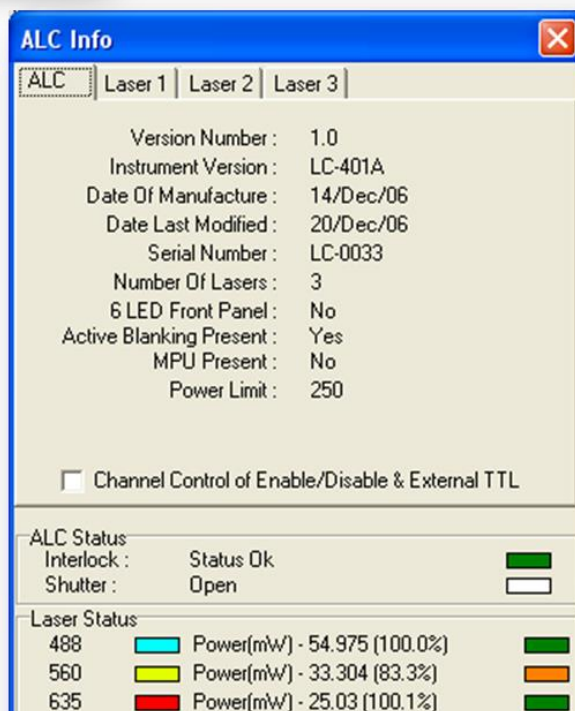

Lastly, we can see the **Power** at each laser and that the 560 laser has not reached ready status, showing 83% power and an orange status box.

The **Channel Control of Enable/Disable & External TTL** checkbox, as the name suggests, allows the laser to be enabled or disabled in the Channel. When this is not checked, the lasers must be disabled and enabled manually by the user. When this checkbox is selected, pressing the **Record** button in Device Setup will also record the laser enabled/disabled status to that Channel, hence allowing the Channel and Protocol to enable or disable the lasers.

Note: When this feature is enabled, switching between Channels in Device Setup may be less responsive because iQ needs to check the laser status. Protocol speeds will not be affected.

Note: A laser that has been disabled will take time to warm up again after being re-enabled. It is therefore not recommended to disable then re-enable a laser during an experiment.

This status can be seen in each separate laser tab as below:

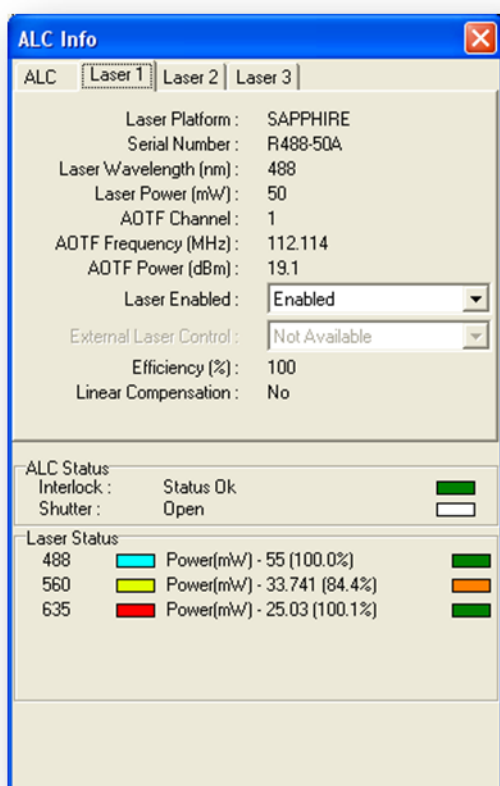

Here, the **Laser Enabled** dropdown menu allows the laser to be turned on and off. This can be useful when an experiment only requires one laser for example, and can increase the lifetime of the unused lasers by disabling them. Another useful strategy would be to create a Channel, perhaps called “Lasers OFF”, enable the **Channel Control of Enable/Disable & External TTL** and disable each laser. **Record** this to the Lasers OFF Channel and insert a “Move to” this Channel at the end of a Protocol. This way, overnight experiments would turn off the lasers when the Protocol is completed.

Lastly, some laser platforms, notably the CUBE from Coherent and MLD from Cobolt, allow **External Laser Control**. This feature, introduced in iQ 2.7, allows the lasers to be directly modulated by a TTL signal. The AOTF and shutters will still operate in the same manner, the shutter open will allow the light to be transmitted and the AOTF is used to select the appropriate wavelength(s) and also adjust the intensity of the individual wavelengths. However when a laser is switched into external mode, a high TTL signal applied to the external TTL connection will cause the laser to emit and a low signal will cause the laser to be turned off. The lasers can be modulated at several MHz to facilitate advanced imaging techniques such as FLIM.

A3.16 Virtual Camera

The Virtual Camera has been designed to allow users to capture images using cameras other than those currently provided by Andor, either indirectly by using screen capture (from a 3rd party application) or directly from many different types of live sources including network cameras, web cams, capture cards, TV tuners and dv cameras. It can also be used in combination with an Andor camera to provide truly asynchronous control of the Andor FRAPPA devices (FRAPPA, MOSAIC and Micropoint).

The camera provides access to Capture from

- any DirectShow or WDM compliant device
 - capture cards,
 - webcams
 - TV tuners.
- HD digital tuners
- Screen Capture

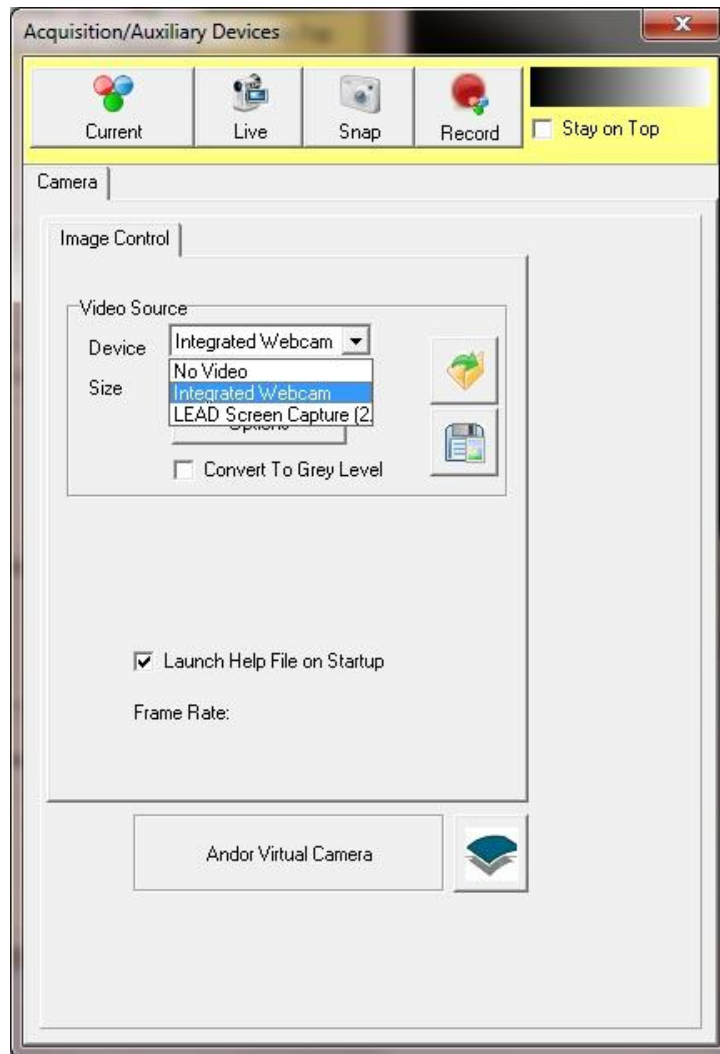

When iQ loads, the virtual camera will scan the system and list the available devices in the “Device” drop down control. Select the appropriate item to gain access to that device.

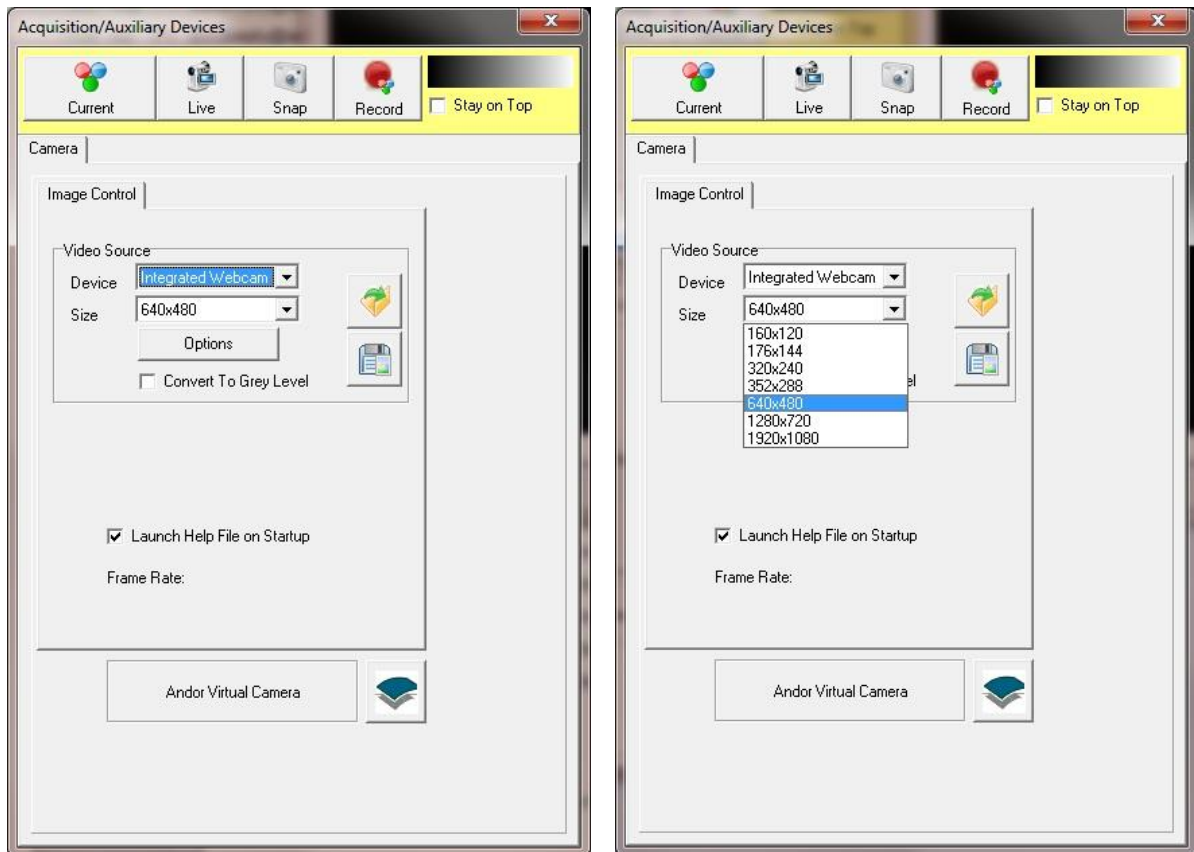

For devices which provide a discrete list of image sizes, then these will be listed in the “Size” drop down.

Andor iQ How To Documents

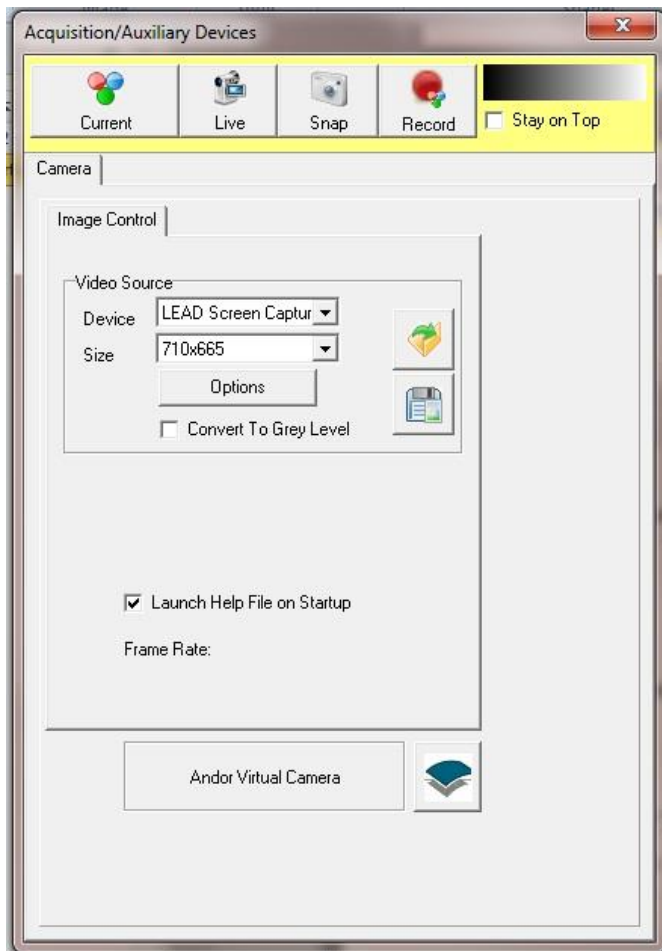

When “Screen Capture” is selected a single size will be listed, to adjust the capture window click the Options button.

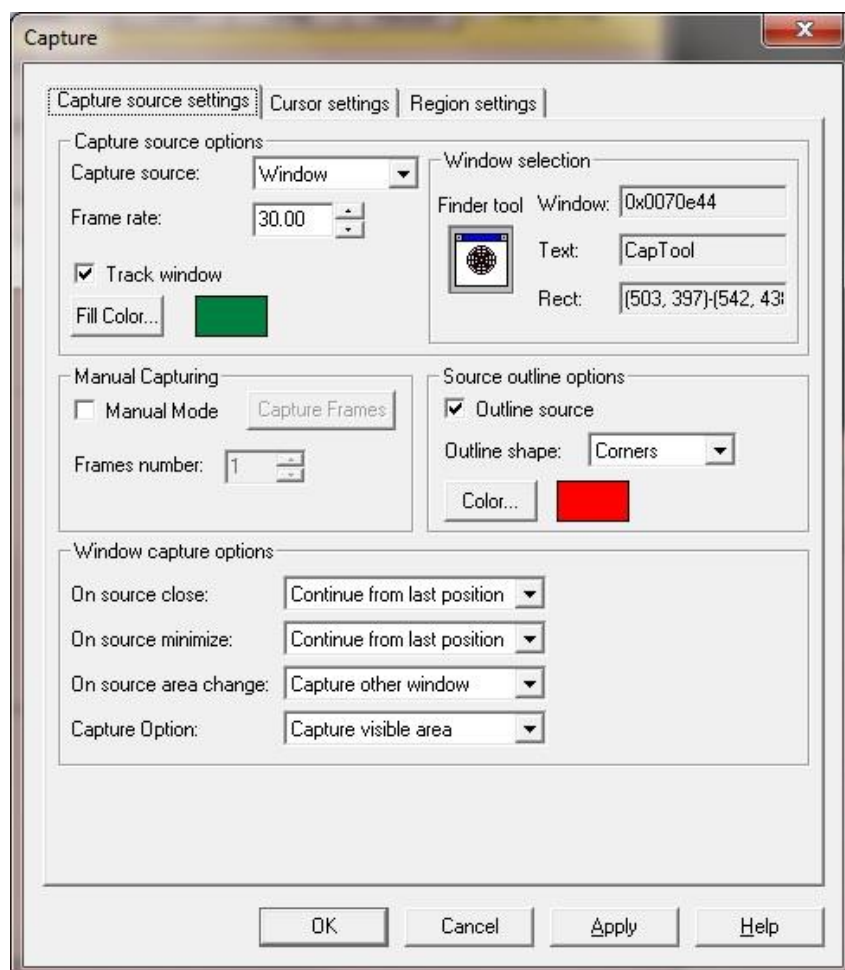

The dialog provides options for selection of the source window or specific region on the screen. The recommended option is to select a specific window. Here click and drag the “Finder tool” icon onto the window to be captured. As you move the mouse around the screen each window panel will highlight, this indicates that the window has focus. Release the mouse button to complete selection.

By selecting “Track window”, you can automatically adjust the region to be captured. If the selected window is moved then the region will adjust appropriately. Note that size will not be adjusted.

The tracking feature is only available within a session, once iQ is closed then the window tracking will be lost. On startup iQ will remember the last position used but it cannot continue to track the window as it is moved. To re-enable tracking the window must be re-selected using the steps above.

One important application of the screen capture is Active Imaging, where we would like to perform Frap, Photo Activation or un-caging without affecting the capture sequence. Here we do not want the control of the Frap device (Frappa, Mosaic or Micropoint) to interrupt the capture. 2 applications are run, one to do the actual capture and one to control the Frap device.

Screen capture allows the iQ instance that controls Frap to gain access to the images without any explicit sharing being required. A calibration process will ensure that any regions drawn within the Frap application will match the equivalent ones within the capture application. Regions can be drawn around particular features on the image with the knowledge that when the Frap is initiated that feature will be correctly illuminated.

One important thing to remember is that the image view of the capture application should not be resized since this will invalidate any calibration. If a window is resized then the calibration process must be rerun. Tracking can be used so long as the window size remains constant. Also ensure that the capture window is not occluded as this will be reflected in the screen captured image, the capture is WYSIWYG, What You See Is What You Get.

Another application is where Frap is used in conjunction with an Electrophysiology system. In order to stimulate the appropriate feature, iQ must be capable of capturing a reference image. Many systems have an IR camera attached which is capable of providing a suitable reference image. There are many low cost capture devices such as EzCap, USB capture device, which will capture from such cameras. Once the driver is installed on the system the video capture device will be listed in the Device drop down.

A separate license is required for the "Virtual Camera" module. Contact Andor support for further details.

A3.17 'Rotr', Andor Filter Wheel

A3.17.1 The Settings Page

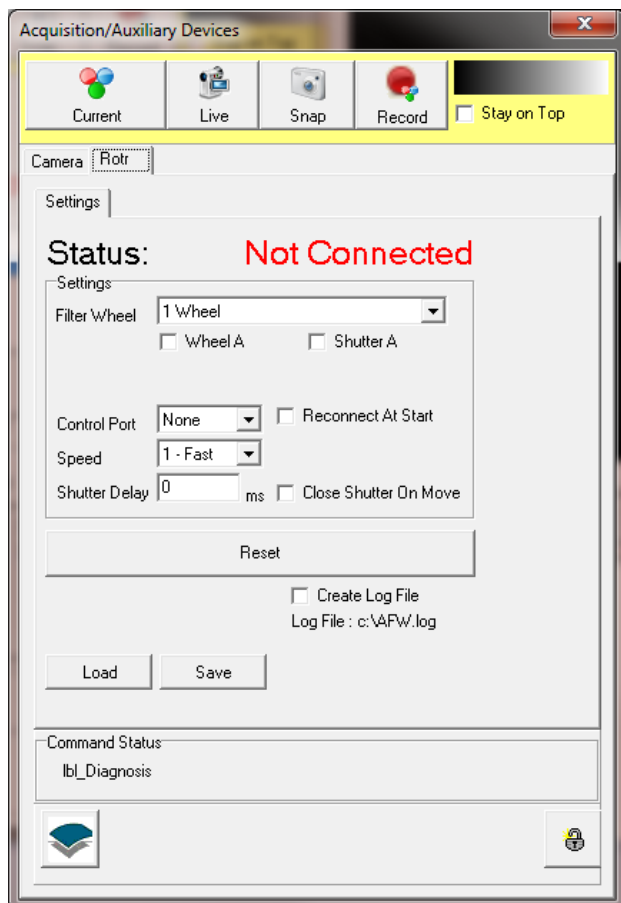

Andor provides a high speed filter wheel solution for imaging, Rotr. The filter modules which can be daisy chained to provide control for up to 3 independent filter wheels. This is supported by iQ and as with all controllers access is via the **Device Setup** dialog. The figure left shows a configuration with **Rotr** tab selected.

The **Settings** page is used to Select the number of wheels, speed and COM port for control. Load and Save Buttons allow you to maintain details of filter information loaded into the wheel.

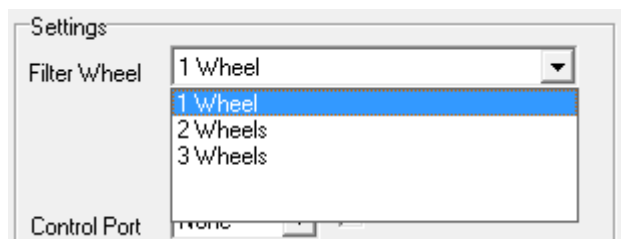

From the **Filter Wheel** dropdown listbox, select the filter wheel combination that you are using.

Available options are:

- 1 Wheel** - controls one filter wheel only.
- 2 Wheels** - controls up to two filter wheels (Wheel A and Wheel B).
- 3 Wheels** - controls up to three filter wheels (Wheels A, B, C).

Note that wheel A is the one with the computer connection and wheel C is farthest along the chain.

Andor iQ USER GUIDE

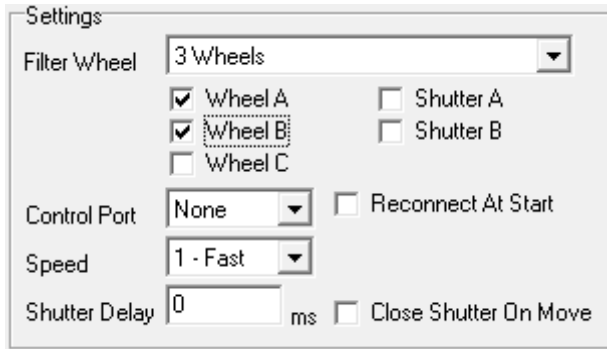

When you select one of the filter wheel options, the interface will provide a set of check boxes to tell iQ what you want to control, as shown left. Check the boxes of components you want to control.

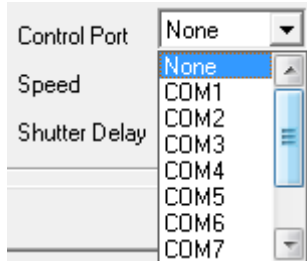

The filter wheel is controlled through one of the serial ports on your computer. From the **Control Port** dropdown select the port you are using.

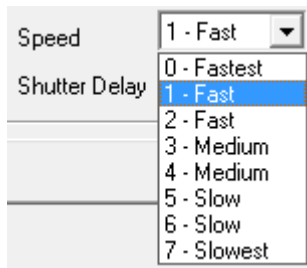

From the **Speed** dropdown listbox, select the speed at which the filter wheel will change position. Speed 0 is the fastest and speed 7 the slowest. **Note** all speeds are guaranteed to function without correction. Filter load affects inertia and positioning performance however the device can self-

compensate to provide robust high speed operation. Refer to the manual for more information.



The command being written to the COM Port is displayed in the **Command Status** section

of the dialogue. You should not send further commands to the filter wheel if a command is currently being written

Pressing the **Reset** button will reinitialize the filter wheel. In the unlikely event that the Andor Software stops talking to the Rotr Filter Wheel, pressing **Reset** can resolve the problem.

Press the **Save** button to save the current settings to file. This will open a standard Windows save file dialogue, from which you can specify the filename, drive and directory to which to save the current settings.

The settings can be reloaded at a future date by pressing the **Load** button. This opens a standard Windows open file dialogue, from which you can select a settings file to load.

A3.17.2 Wheel Settings

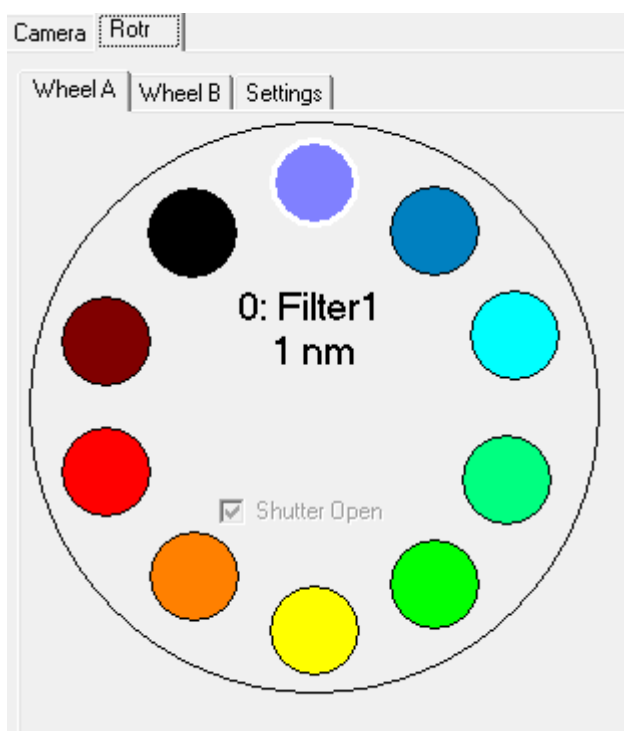

The Andor Rotr can handle up to 3 wheels.

Parameters for controlling the wheels are identical from a user interface point of view and so we describe this once.

The filter wheel has ten positions, each represented in the dialogue by a coloured circle. If you move the mouse cursor over one of the positions, the name and appropriate value (e.g. wavelength) of that position is displayed in a popup.

A left click on one of the positions will move the filter wheel to that position. The name and assigned value of the current position is displayed at the centre of the wheel dialogue.

A right click on one of the positions opens the **Filter** dialogue, in which parameters for that position can be specified.

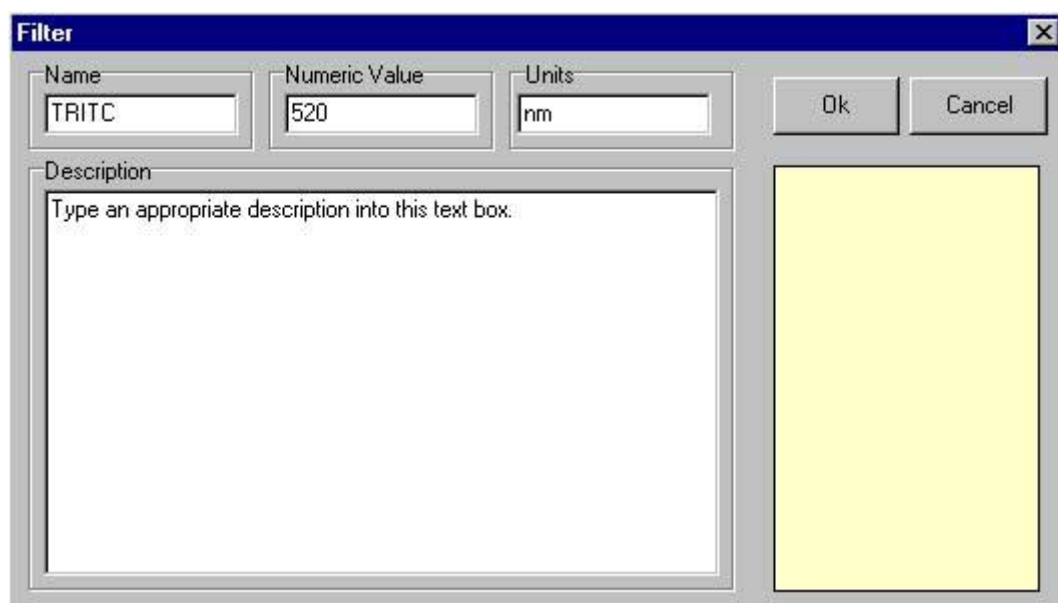

The name of the Filter represented by the selected position should be entered into the **Name** text box.

The numeric value (i.e. the wavelength) of the filter represented by the selected position should be entered into the **Numeric Value** text box.

The Units of the Filter should be entered into the **Units** text box (default is nm).

IMPORTANT NOTE:

You must give each filter position a *different* name and value to avoid confusion as the controller uses these names to index the wheel.

When moving the mouse over a filter position in the Wheel dialogue the name, numeric value and units assigned to that position will be displayed in a popup. The name, numeric value and units of the currently selected position are displayed at the centre of the Wheel dialogue.

Descriptive text can be associated with each filter position, to display user information about the filter at the selected position. Simply type the required text into the Description text box.

Press **OK** to close the **Filter** dialogue, accepting any changes to the settings.
Press **Cancel** to exit the **Filter** dialogue, ignoring all changes.



Clicking in the lower right hand box of the **Filter** dialogue opens a colour palette.

Selecting a colour from the palette, or defining a custom colour, will display the selected filter position as a circle of that colour in the Wheel dialogue.

A3.18 Yokogawa CSU

A3.18.1 The Settings Page

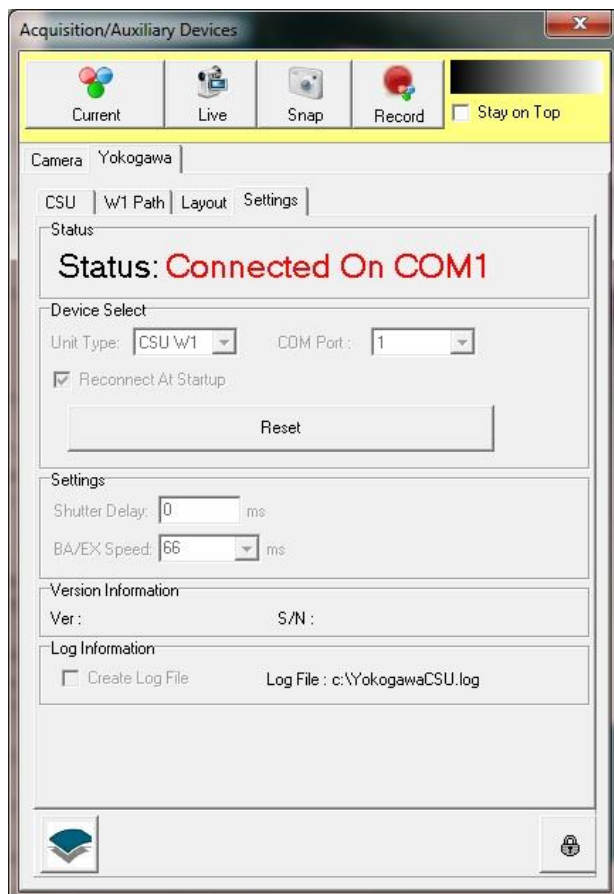

Yokogawa provides several CSU models. These are supported by iQ and as with all controllers access is via the **Device Setup** dialog. The figure on the left shows a configuration with the **Yokogawa** tab selected.

The **Settings** page is used to select the CSU model, filter wheel speed, COM port used for control and the shutter delay.

From the **Unit Type** dropdown listbox, select the model that you are using.

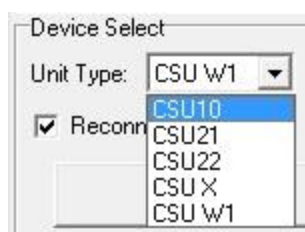

Available options are:
CSU10, CSU21, CSU22, CSU-X and CSU-W1

CSU10 -

- Master shutter only.

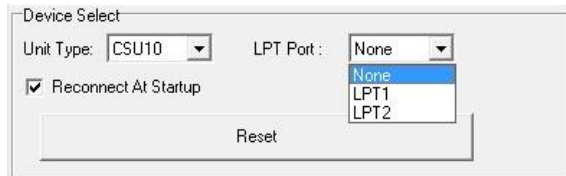

CSU10 is controlled using the parallel port of the PC.

CSU21/22 -

- 3 position dichroic filter slider
- 3 position emission filter slider
- 3 position excitation filter slider
- Confocal Spinning Disk (1800-5000 rpm)
- Master shutter

CSU-X -

- 3 position dichroic filter slider
- Optional 12 position emission filter wheel
- Optional 12 position excitation filter wheel
- Confocal Spinning Disk (1500-5000 rpm)
- Optional high speed disk (1500-10000 rpm)
- Wide field bypass mirrors
- Master shutter

CSU-W1 -

3 basic model T1, T2 and T3 with combination of the following,
see Yokogawa documentation for full list of CSU-W1 options.

- 3 position dichroic filter slider
- Optional 3 position camera port/splitter slider
- Optional 3 position photo-bleach slider
- Optional 6 or 10 position filter wheel(s)
- 50um, 25um or dual confocal spinning disk(s) (fixed speed 4000rpm)
- Wide field, bypass mode (disk moved out of optical path)
- Aperture
- Optional mag lens at port(s)
- Visible, NIR and Photo-bleach shutters

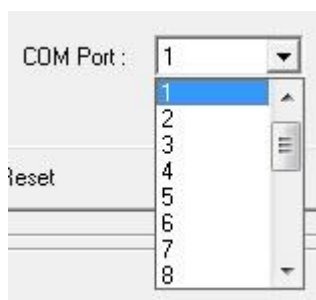

The CSU21, CSU22, CSU-X and CSU-W1 models are controlled through one of the serial ports on your computer. From the **COM Port** dropdown select the port you are using.

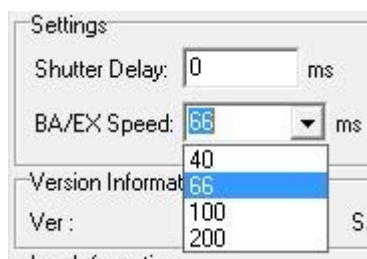

Available for the CSU-X and CSUW1 models (where filter wheel(s) are connected), the **Speed** dropdown listbox selects the speed at which the filter wheel will change position. The values displayed represent the time the wheel will take to move between adjacent filters.

Times displayed are for the CSU-W1 T2 model. CSU-W1 T3 model can achieve 100ms and 200ms only. CSU-X has switch times of 66, 100 and 200ms, with an optional high speed wheel which can achieve 33ms switch time.

Note that the same speed is applied to all wheels.

Filter load affects inertia and positioning performance however the device can self-compensate to provide robust high speed operation. Refer to the manual for more information.

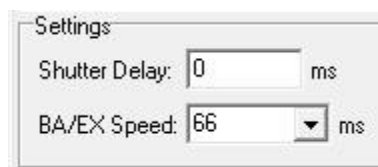

The Shutter Delay describes the time taken in milliseconds to open the shutter and to close the shutter. Simply enter the value into the text box.

Note that the shutter used in the CSU models has a limited lifetime (finite number of open/close actions). It is recommended that the CSU shutter is not used during an experiment for inter-frame blanking. It can however be used to safely blank the light post acquisition.

Pressing the **Reset** button will reinitialize the filter wheel. In the unlikely event that the Andor Software stops talking to the CSU device, pressing **Reset** can resolve the problem.

A3.18.2 Layout Panel

The layout panel will illustrate the properties/features that are available for your particular CSU model.

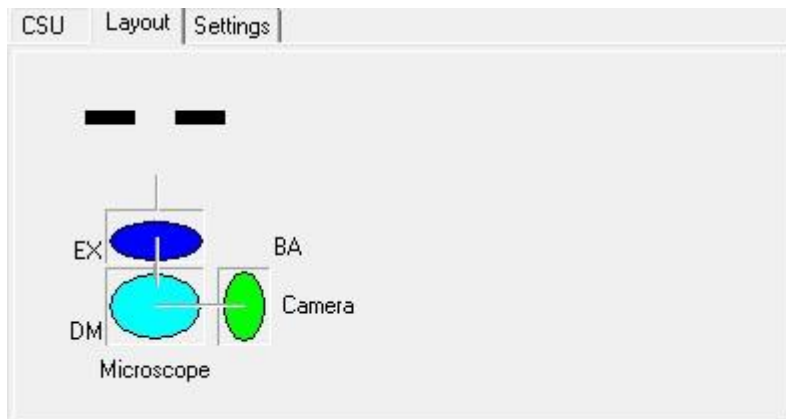

Here we illustrate the panel displayed for the CSU 10, 21, 22 and X. The elements on this panel will update dynamically as the various properties are changed.

For the CSU-W1 due to the complexity and variety of options, we simply display an overview diagram as follows.

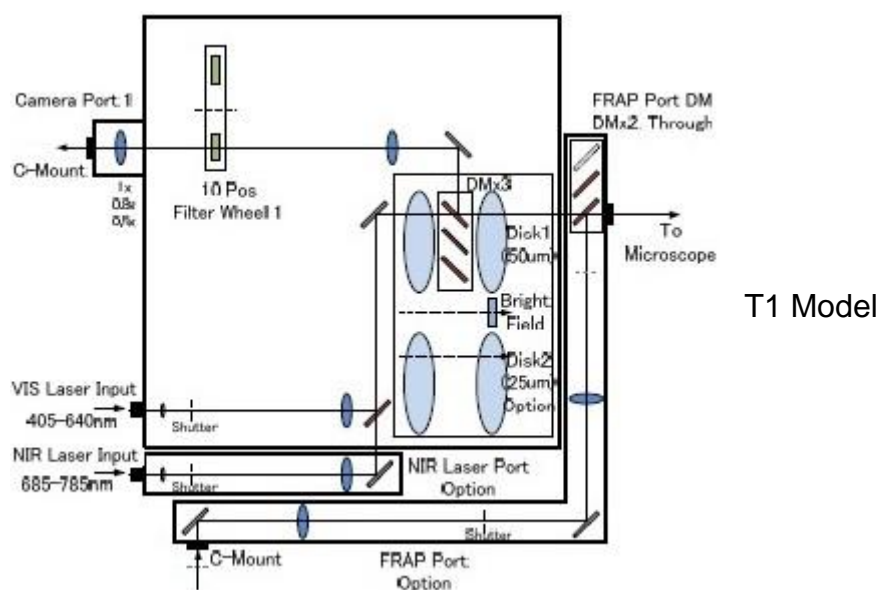

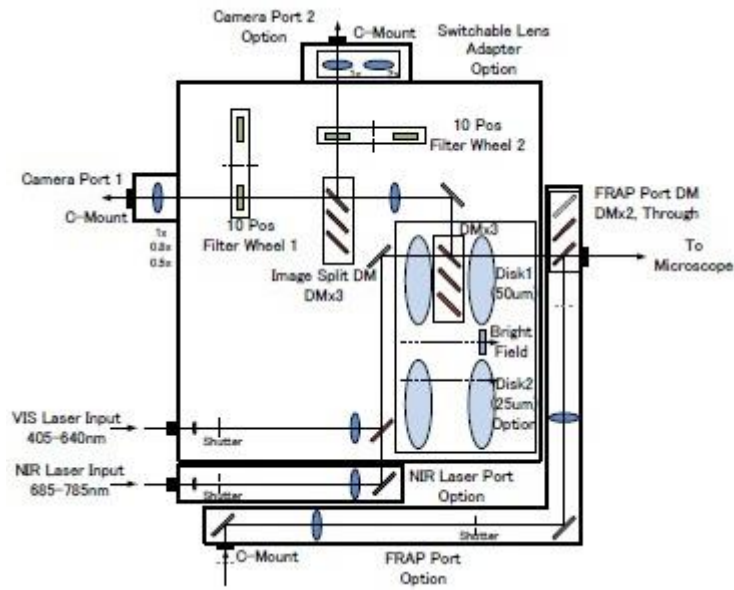

T2 Model

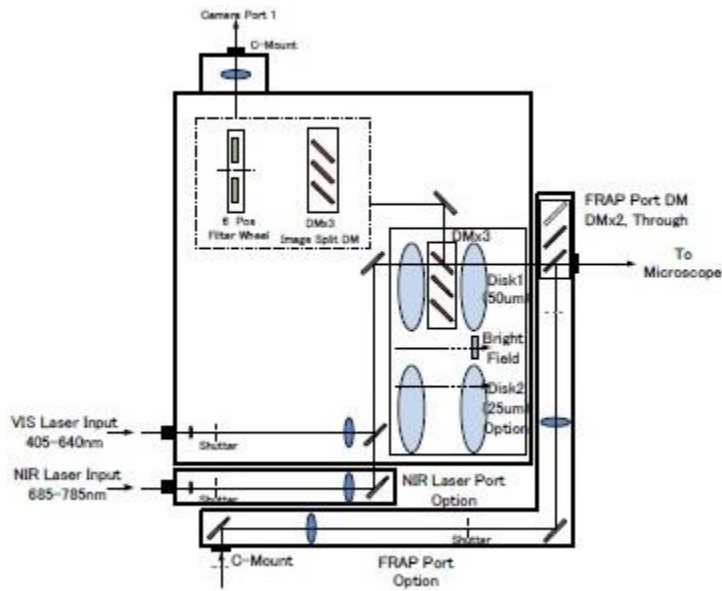

T3 Model

A3.18.3 Selecting and Editing parameters

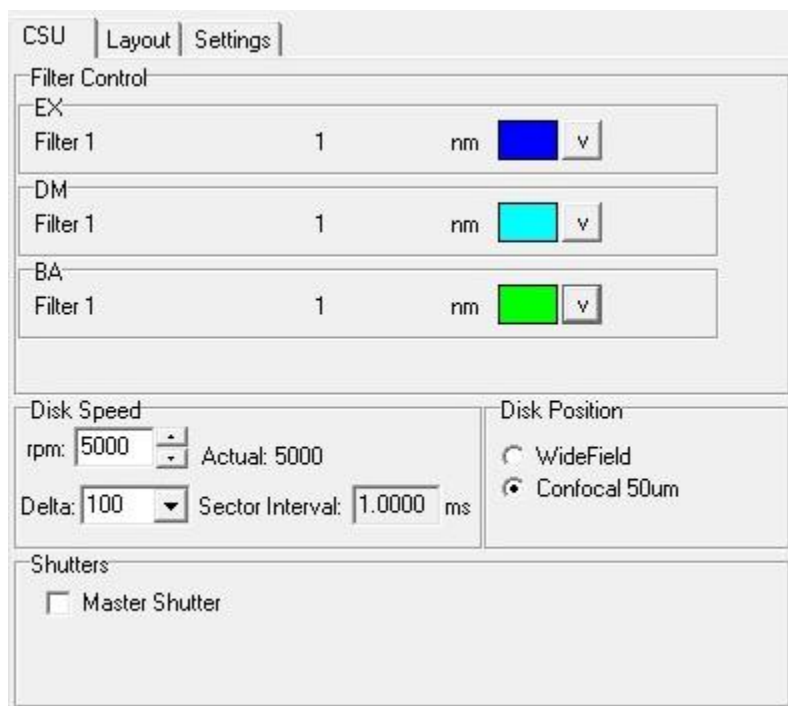

The CSU-X can handle up to 2 wheels (EX and BA above), these have 12 positions. *CSU21 and 22 will look identical but will provide only 3 positions for each slider.*

Each of the available features are controlled through the same kind of interface, as follows:

A left click on the coloured region or arrow will drop down a menu which is used to select and move to a different position.

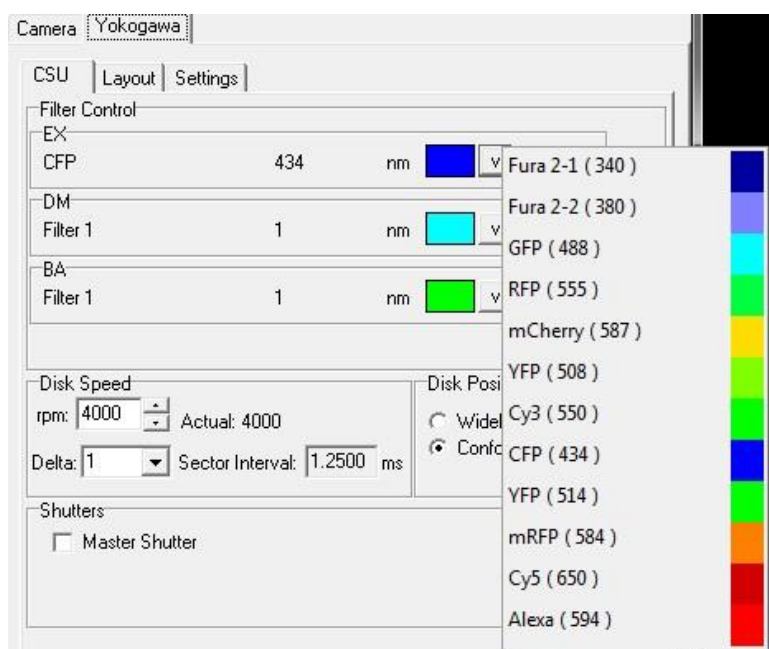

The filter wheel has twelve positions, each represented in the menu by a coloured element. Select one to move the filter wheel to that position. The name and assigned value of the current position is displayed in the control.

Right-clicking on the coloured region or arrow will instead pop up the menu in edit mode. Selecting one of the positions opens the **Filter** dialogue, in which parameters for that position can be specified.

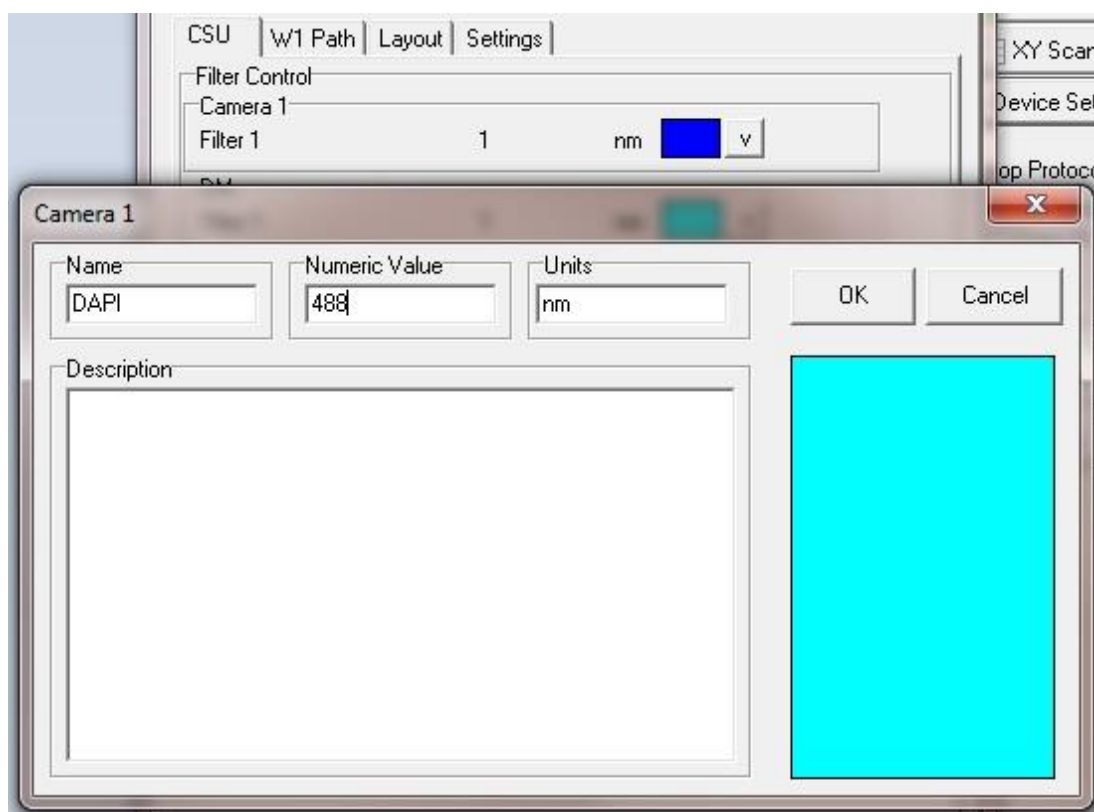

The name of the Filter represented by the selected position should be entered into the **Name** text box.

The numeric value (i.e. the wavelength) of the filter represented by the selected position should be entered into the **Numeric Value** text box.

The Units of the Filter should be entered into the **Units** text box (default is nm).

IMPORTANT NOTE:

You must give each filter position a *different* name and value to avoid confusion, as the controller uses these names to index the filter.

Descriptive text can be associated with each filter position, to display user information about the filter at the selected position. Simply type the required text into the Description text box.

Andor iQ USER GUIDE

Press **OK** to close the **Filter** dialogue, accepting any changes to the settings.

Press **Cancel** to exit the **Filter** dialogue, ignoring all changes.

Clicking in the lower right hand box of the **Filter** dialogue opens a colour palette.



Selecting a colour from the palette, or defining a custom colour, will display the selected filter position as a block of that colour in the filter dialogue.

A3.18.4 Editing parameter names

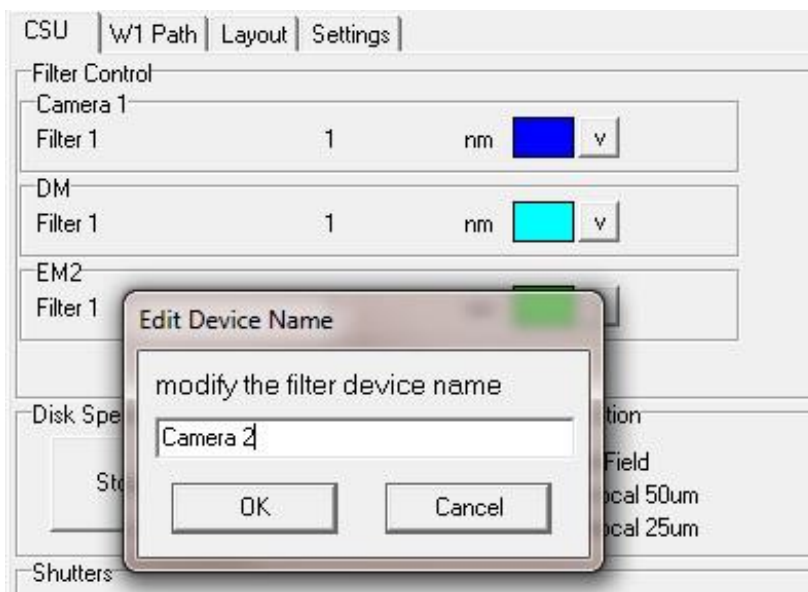

A right click on the parameter name will pop up an edit dialog as shown. Here we clicked on the name "EM2".

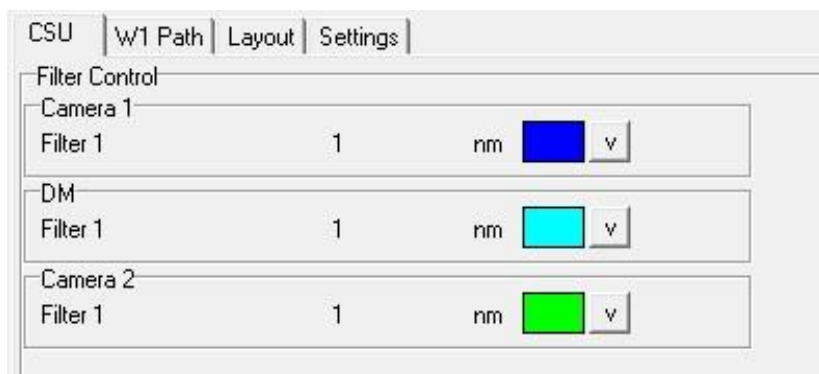

Enter the name as required.

In this example the filter wheel for the CSU-W1 is assigned to "Camera 2"



Parameter name after editing.

A3.18.5 CSU-X parameters

CSU		Layout	Settings
Filter Control			
EX			
Filter 1	1	nm	 v
DM			
Filter 1	1	nm	 v
BA			
Filter 1	1	nm	 v
Disk Speed		Disk Position	
rpm:	<input type="text" value="5000"/>	Actual:	5000
Delta:	<input type="text" value="100"/>	Sector Interval:	<input type="text" value="1.0000"/> ms
		<input type="radio"/> WideField <input checked="" type="radio"/> Confocal 50um	
Shutters			
<input type="checkbox"/> Master Shutter			

Excitation Filter wheel

Dichroic Mirror

Emission Filter Wheel

Disk speed

Bypass option (if available)

Master shutter

The excitation, emission and dichroic mirror behave in a manner as described in section A3.17.3 “Selecting and Editing parameters” above.

The shutter will open when the box is checked and close when it is unchecked.

Disk speed control is used to adjust the rotation speed of the confocal spinning disk and can be used to provide a best match for the exposure of the camera. To get the best image ensure that the exposure time is a multiple of the sector interval. For example, at 5000 rpm the corresponding exposure needs to be a multiple of 1ms. If the exposure and disk speed are mismatched then artifacts will be seen on the image. To adjust the disk speed either type in the edit box or use the up/down jog buttons. The delta control can be used to adjust the size of each step. The disk speed will be clamped at the limits of the device, for the CSU-X the upper/lower limits are 1500 and 5000 (or 10000 for the high-speed model) respectively.

A3.18.6 CSU-W1 parameters

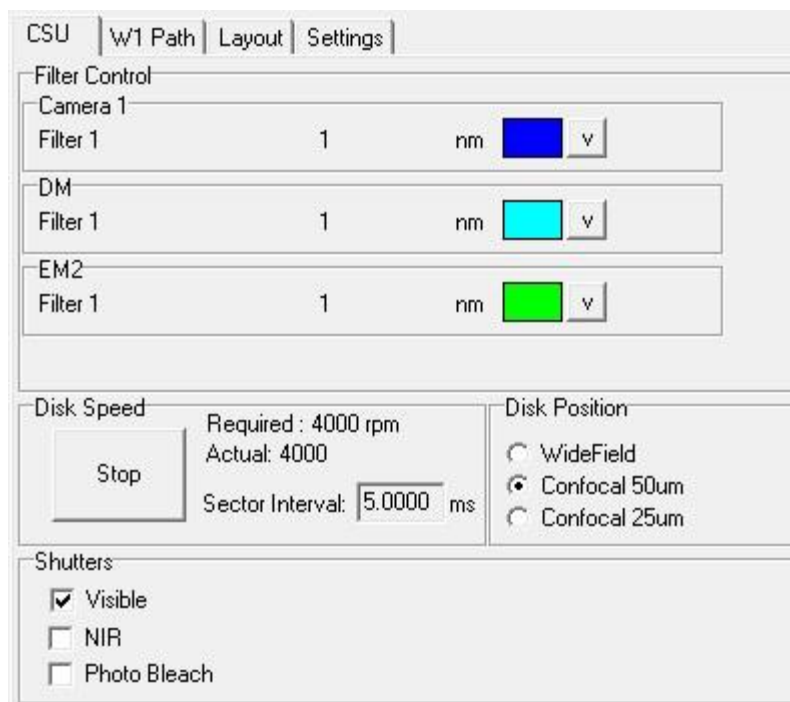







For the W1 models, filters and shutter will behave as in the previous section. For the Dual camera (T2) model it is suggested that the filter wheels be labeled appropriately. This will reduce any confusion during channel creation and editing. Here we label the first wheel “Camera 1”, as an alternative you could use the name of the camera. See section A3.17.4 “Editing parameter names”.

Disk Speed has been fixed at 4000 rpm, which will provide a sector interval of 5 ms. Therefore to get the best image ensure that the exposure time is a multiple of 5 ms.

The Stop/Start option provides the user with the ability to display the confocal disk pattern. This is useful for calibrating the dual camera (T2) and split view (T3) configurations within the field split plugin. Once calibrated, this plugin can be used to correct for any distortion that may exist between the two image paths. See 6.3 “Field Split Plugin” for detail.

The Disk Position will allow you to select between wide field, high contrast (50um) or high sectioning (25um) disks. Depending on the W1 model, you may have one or two confocal spinning disks. The option will be greyed out if it is not available. Note that when switching between disks, there is a possible delay of up to 15 seconds. This is required to ensure that the disk has moved into the optical path and has reached the required rotation speed.

CSU	W1 Path	Layout	Settings
Camera Port			
Dual Camera	3	nm  v	<input type="checkbox"/>
Aperture			
5	12.7	mm  v	<input type="checkbox"/>
Photo Bleach			
Filter 1	488	nm  v	<input checked="" type="checkbox"/>
Magnification Lens 1			
Mag 1	1	 v	<input type="checkbox"/>
Magnification Lens 2			
Mag 1	1	 v	<input type="checkbox"/>
NIR Dichroic Mirror			
NIR	690	nm  v	<input type="checkbox"/>

Channel Control :

NB select check box to allow property to be controlled within a channel

A second panel, “W1 Path”, will activate when the CSU-W1 option is selected. Controls are provided for the features which are unique to this W1 models.

The check box besides each feature will enable channel control.

Note that the Aperture values cannot be edited.

A3.19 Andor Mosaic Device

Introduction

The functionality of Mosaic 3 has been extended to provide programmable sequencing and external triggering.

Device Setup

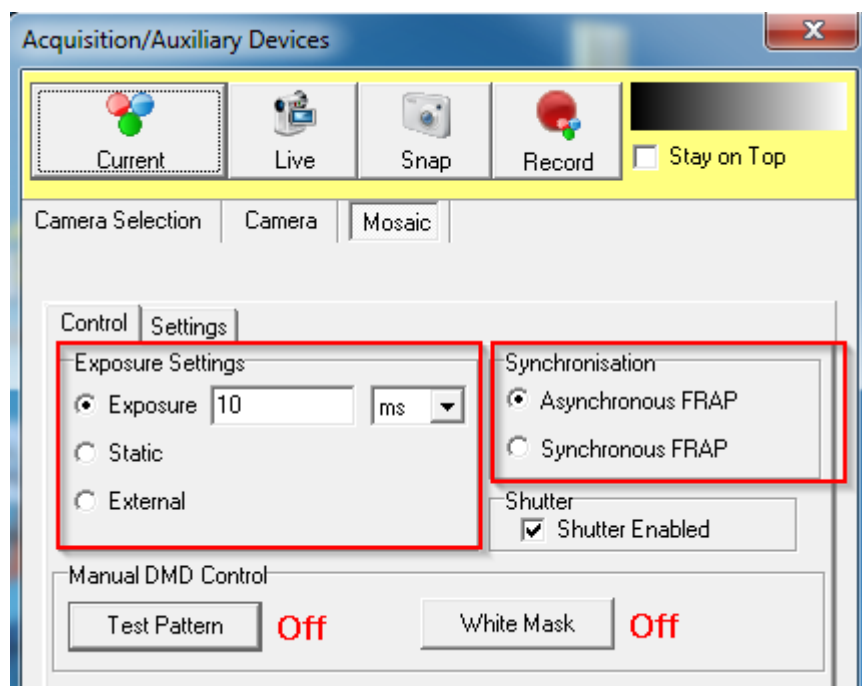

Exposure Setting	Description
Exposure Time	Sets how long the Frappa regions are illuminated for before they're switched off
Static	Illuminates Frappa regions until they're switched off
External (Bulb)	Frappa region illumination is controlled by external TTL signal: low = off, high = illuminated

Synchronisation	Description
Asynchronous FRAP	Region illumination and sequencing is started but not waited for completion
Synchronous FRAP	Region illumination and sequencing is started and waited for completion

Regions of Interest

Regions of Interest graphically define what areas of the sample will be illuminated by the Mosaic device. The regions can be illuminated manually or as part of a programmed sequence.

Two types are used:

Region Type	Description
_FRAPPA	Illumination is toggled between on and off.
_Imaging	Always illuminated during acquisition.

This example shows an acquired image with three _FRAPPA regions and one _Imaging region:

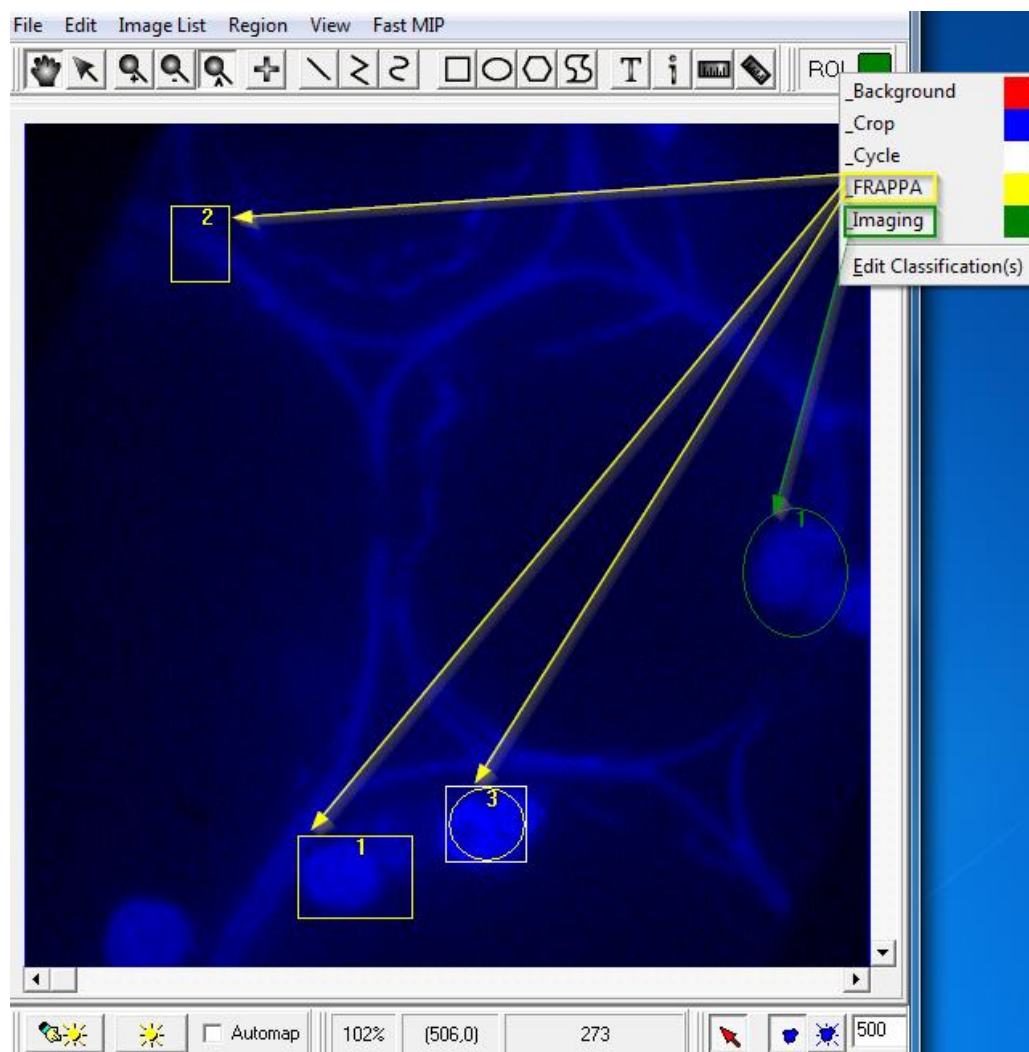

Sequencing

Regions can be illuminated by programmed sequences that are uploaded to and stored on the Mosaic 3 device. This means that triggering the sequences has very little latency since all frame graphics are already in device memory.

A **Sequence** consists of one or more **Time Slots** which define what Frappa and Imaging regions will be illuminated and for how long.

Sequencing is controlled from the **iQ Mosaic Region Sequencing** design dialog that is opened from the image window **Region | Mosaic Region Sequencing** menu:

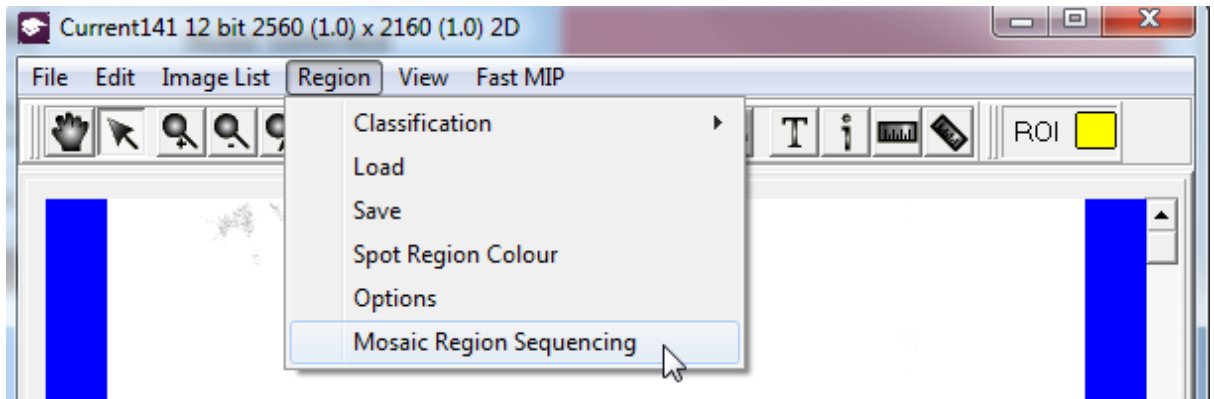

Andor iQ USER GUIDE

The workflow for sequencing is:

1. Generate a sequence
2. Optionally customize the sequence's time slots
3. Upload the sequence to the Mosaic device
4. Run the sequence either immediately or under external trigger control

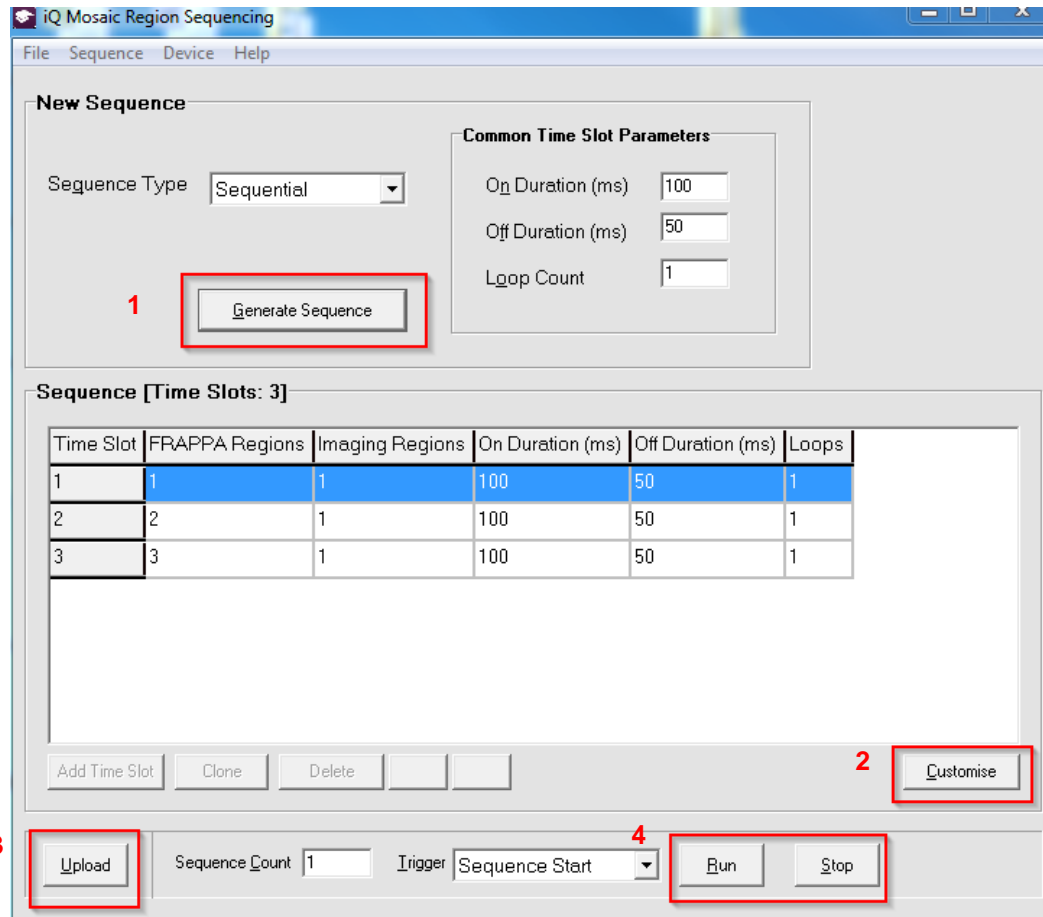

Note: if the following warning appears when a Sequence is generated then some Regions of Interest need to be created. The Sequence can then be re-generated.

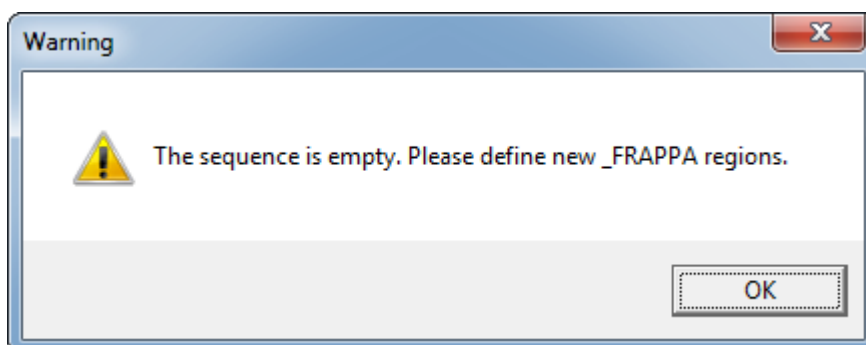

Sequence Types

Three different types of sequence that correspond to the most common illumination patterns can be generated:

Type	Frappa Region Illumination
Sequential	Individual regions in order
Cumulative	Expanding groups
Simultaneous	All regions at the same time

The sequence type is available in a drop-down control on the sequencing form:

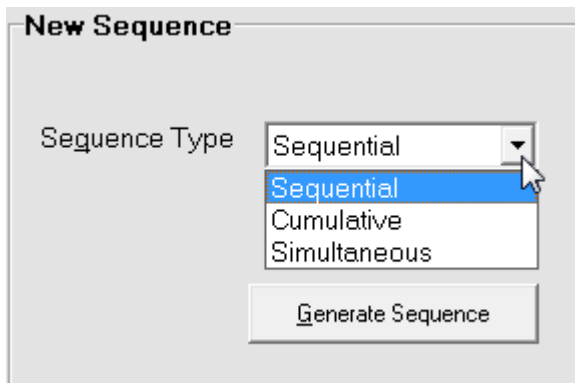

The following tables describe the patterns of the generated sequence types for three Frappa regions and when Imaging regions are absent and present.

Sequential Sequence Patterns











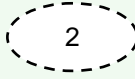
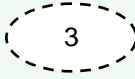

Time Slot	Slot State	Imaging Regions	FRAPPA Regions
1	On	None	  
	Off	None	  
2	On	None	  
	Off	None	  
3	On	None	  
	Off	None	  

Table 1 - Sequential sequence with no defined Imaging Regions



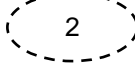
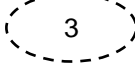



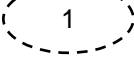
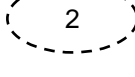
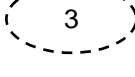





Time Slot	Slot State	Imaging Regions	FRAPPA Regions
1	On		  
	Off		  
2	On		  
	Off		  
3	On		  
	Off		  

Table 2 - Sequential sequence with a defined Imaging Region

Cumulative Sequence Patterns

Time Slot	Slot State	Imaging Regions	FRAPPA Regions
1	On	None	
	Off	None	
2	On	None	
	Off	None	
3	On	None	
	Off	None	

Table 3 - Cumulative sequence with no defined Imaging Regions

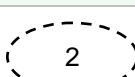
Time Slot	Slot State	Imaging Regions	FRAPPA Regions
1	On		
	Off		
2	On		
	Off		
3	On		
	Off		

Table 4 - Cumulative sequence with a defined Imaging Region

Simultaneous Sequence Patterns



Time Slot	Slot State	Imaging Regions	FRAPPA Regions
1	On	None	
	Off	None	

Table 5 - Simultaneous sequence with no defined Imaging Regions



Time Slot	Slot State	Imaging Regions	FRAPPA Regions
1	On		
	Off		

Table 6 - Simultaneous sequence with a defined Imaging Region

Andor iQ USER GUIDE

The **Common Time Slot Parameter** values are applied to all the Time Slots of any generated sequence.

Parameter	Definition
On Duration	How long the Frappa regions are illuminated in milliseconds
Off Duration	How long the Frappa regions are hidden in milliseconds
Loop Count	How many times the Time Step is used before continuing the sequence

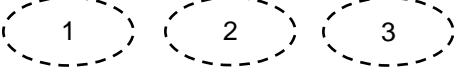
New Sequence

Sequence Type:

Common Time Slot Parameters

On Duration (ms):

Off Duration (ms):

Loop Count:

Sequence [Time Slots: 3]

Time Slot	FRAPPA Regions	Imaging Regions	On Duration (ms)	Off Duration (ms)	Loops
1	1	1	100	50	1
2	2	1	100	50	1
3	3	1	100	50	1

Customise

The three generated sequence types cover the most common illumination patterns but if specific patterns are required then the customization tools can be used.

To customize a generated sequence, click the **Customise** button:

Sequence [Time Slots: 4]

Time Slot	FRAPPA Regions	Imaging Regions	On Duration (ms)	Off Duration (ms)	Loops
1	1		100	50	1
2	2		100	50	1
3	3		100	50	1
4	4		100	50	1

Add Time Slot Clone Delete **Customise**

This unlocks the Time Slot grid cells for editing along with the customization controls:

Sequence [Time Slots: 4]

Time Slot	FRAPPA Regions	Imaging Regions	On Duration (ms)	Off Duration (ms)	Loops
1	1		100	50	1
2	2		100	50	1
3	3		100	50	1
4	4		100	50	1

Add Time Slot Clone Delete ▲ ▼ Customise

Control	Purpose
Add Time Slot	Appends a new time slot at the end of the sequence
Clone	Creates a copy of the selected time slot and appends it at the end of the sequence
Delete	Removes the selected time slot from the sequence
Move Time Slot Up/Down	Shifts the selected time slot up or down by one row

Upload

Sequence Count defines how many times the sequence is played on the device. The default is one time.

Trigger determines how the sequence is initiated and whether or not the time slots are stepped through automatically or under external TTL control.

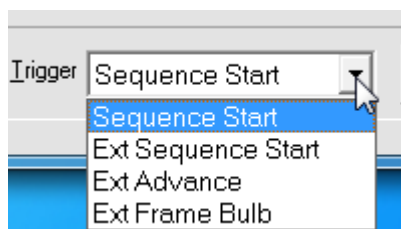

Sequences can be started or triggered in four ways:

Trigger Mode	Description
Sequence Start	The uploaded sequence begins executing immediately
Ext Sequence Start	The uploaded sequence begins executing when the external trigger TTL signal goes high
Ext Advance	The uploaded sequence steps through its Time Slots one at time under the control of the external TTL signal. The illuminated durations are set by the Sequence grid
Ext Frame Bulb	The uploaded sequence steps through its Time Slots one at time under the control of the external TTL signal. The illuminated durations are controlled by TTL high.

Stop

External TTL Trigger

Ext Advance and **Ext Frame Bulb** modes both control the advancement of the sequence time slots.

When Imaging Regions are **not defined** then **one** high-low trigger cycle is required per Sequence Time Slot.

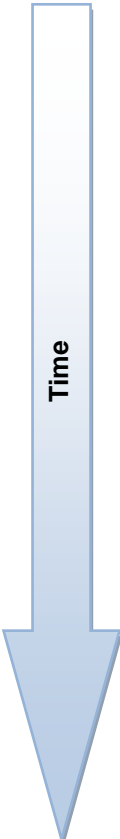







Trigger TTL State	Time Slot	Imaging Regions	FRAPPA Regions
High	1	None	
Low		None	
High	2	None	
Low		None	
High	3	None	
Low		None	

Table 7 - External trigger with no defined Imaging Regions

When Imaging Regions **are defined** then **two** high-low trigger cycles are required per Sequence Time Slot.





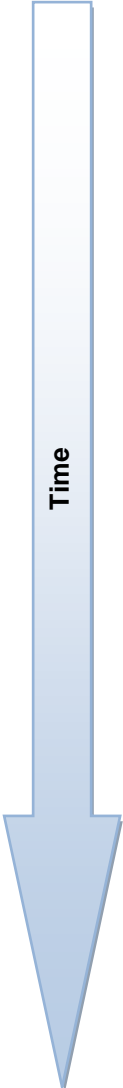









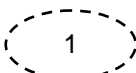
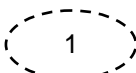

Trigger TTL State	Time Slot	Imaging Regions	FRAPPA Regions
High	1		
Low			
High			
Low			
High	2		
Low			
High			
Low			

Table 8 - External triggering with defined Imaging Regions

Protocol Control

The Sequence defined by the sequencing design form can be triggered from protocol control by using the **Frappa Sequence** node.

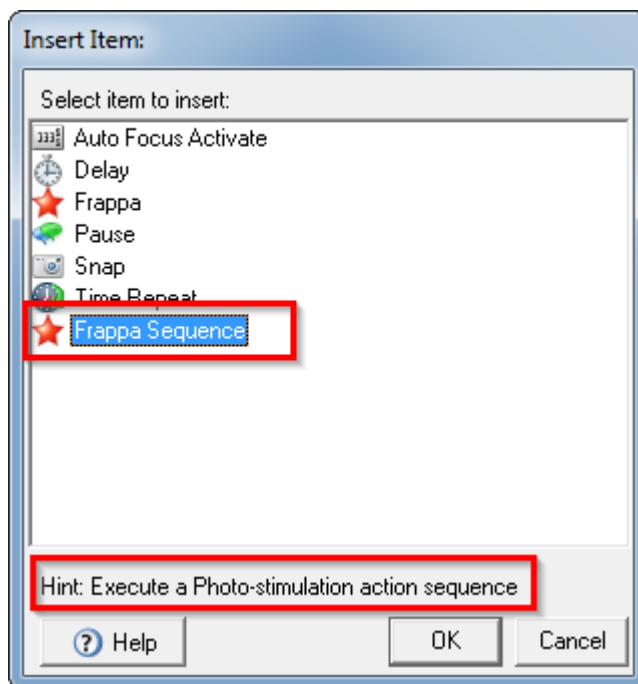
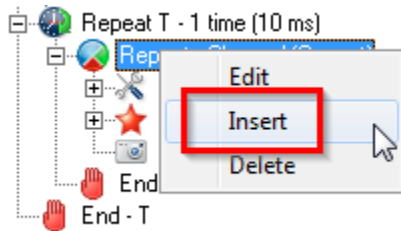

The options for triggering the sequence are set in this dialog:

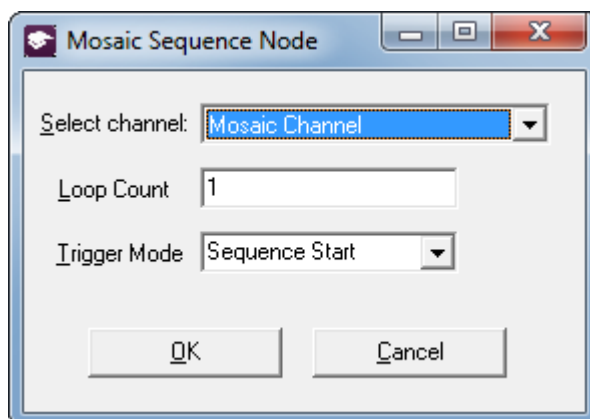

Andor iQ USER GUIDE

The same trigger modes from the sequencing design dialog are available in the protocol node.

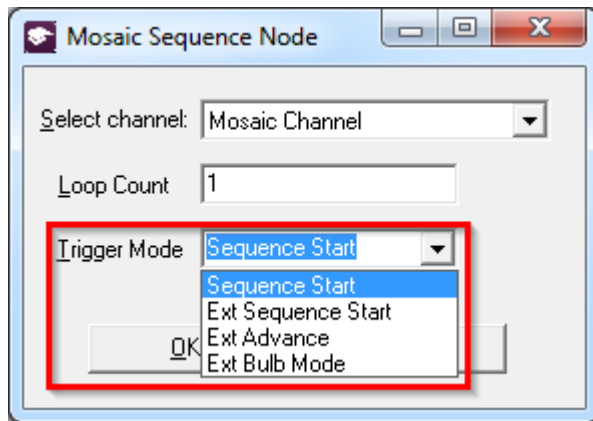

Once inserted, the node looks like this.

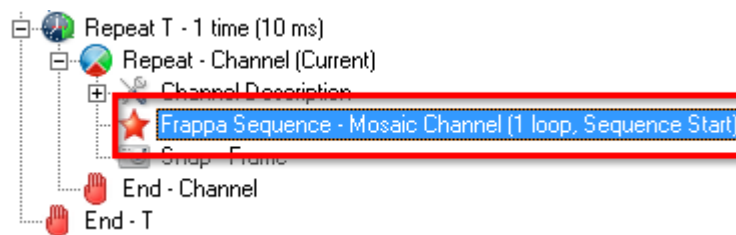

The synchronization option in the Control tab in the device setup form determines if the protocol execution waits for the sequence to complete (Synchronous) or not (Asynchronous).



Appendix 4 – Image Metadata

A4.1 iQ 1.X Image Headers and Metadata

A4.1.1 Introduction

This document presents the structure of iQ 1.10 image headers section by section. Examples will be provided when necessary. The header is constructed like a Windows “*.ini file”, which is managed via section headings and endings, denoted within square brackets e.g.

```
[section1]
```

```
...
```

```
[section1 end].
```

Within these sections we provide relevant information about the image, size, dimensionality, position data and acquisition conditions. Groups of values are usually separated by tabulations. Inside a group, commas are usually used to separate each element.

The beginning of the header contains the name of the image, its creation time and some global information on the image format (type, size in pixels, calibration, dimensions size).

[Created]

This section contains the date and time of the creation of the image.

[XYZScan]

This section contains a summary of the scan pattern.

ScanName: name of the scan pattern.

FileVersion: version number of the header file.

Centre: for internal use only. **Always false, used for backward compatibility only.**

Channel: for internal use only. **Deprecated, used for backward compatibility only.**

WellPattern: name of the well pattern used, only for multi well scans.

Density: density of systematic sampling (number of fields per well in systematic sampling mode), only for multi well systematic sampling scans.

Calibration: calibration (in μm per pixel) in use during the acquisition.

XYFields: the number of fields and their position (a montage section is not a considered as an XY field. See MontageOffsets for montage sections settings). A position is composed of X, Y and Z.

Then follows some settings regarding the Z scan for internal use only (6 letters and 1 number). **Y/N (deprecated, always Y, should refer to Z being centered or not), P/Z/B (P if Number of planes has been selected, Z if Delta Z has been selected, B if End position has been selected), "STEP0" kept for legacy, has no meaning anymore.**

For Z single field scans, no information is displayed here as we don't store the X,Y position of the scan.

(ex: 3 8594.656,12117.763,171.65,YPSTEP0
12211.789,12260.757,175.75,YPSTEP0
9979.865,14038.272,168.85,YPSTEP0)

ZScan: "STEP" followed by the size of a step then the number of steps. In Z single field scans, this is preceded by the center of the z range followed by settings regarding the Z scan (see XYFields) (ex: 189.99,YZSTEP0 STEP50 4).

Montage: the type of montage (Region, Edge, Linear) - "Overlap" followed by the overlap between montage sections in percent - "Width" followed by the width of a montage in μm - "Height" followed by the height of a montage in μm - "Units" followed by the unit used to define the montage in iQ (Fields or MM).

(ex: Region Overlap 5 Width 582.32 Height 581.16 Units Fields)

Plates: the number of plates and a description of each plate. Each plate contains the following information: X and Y of the top-left edge of the top-left well, X and Y of the top-left edge of the second well of the first row, rejection list inside square brackets (the first well's ID is 1, wells are separated by comma), a boolean for the rejection list (1 if it is a rejection list, 0 if it is an inclusion list).

MontageOffsets: the number tiles in a montage and the respective offsets of each tile in the following format: X,Y,Z.

[Region Info (Fields) Field]

This section contains the width and height of a field in μm .

[Region Info (Fields)]

This section contains the position of all fields (including montage sections for

montage scans). All values are separated by a tabulation.

The first line contains the number of fields, the number of columns of the following table, the version number of the data set and the date and time of when the file was written.

The second line contains the titles of each column of the table.

The following lines describe the fields of the acquisition.

[Environment]

This section contains the user name and the iQ configuration name.

[Protocol Description]

This section contains an exact representation of the nD protocol tree.

[Grab Parameters]

This section contains some camera information.

Camera: camera type ("Andor" for Andor cameras).

Window Left: left of the area of the camera chip containing the result image.

Window Top: top of the area of the camera chip containing the result image.

Window Right: right of the area of the camera chip containing the result image.

Window Bottom: bottom of the area of the camera chip containing the result image.

Window Width: width of the area of the camera chip in pixel used for the result image.

Window Height: height of the area of the camera chip in pixel used for the result image.

BinningX: binning of the X axis.

BinningY: binning of the Y axis.

Exposure: exposure time in us.

All sections which name starts with **Tab** contain camera settings from the device setup window.

[Image Info]

This section contains information relative to the camera's chip settings (redundant with most of the fields from the Grab Parameters section).

[Image Bits]

This section is for internal use only.

[First Frame]

This section contains one field “SavedTime” containing the time stamp of the first frame.

[Comments]

This section contains any comment added through the Image Manager. To add user-defined content, select the **Edit Comments** menu item in the Image Manager dialog.

A4.1.2 Examples

1. The example is shown below for a 6 by 4 multi-well image with 5 fields per well set in systematic sampling mode. The wells 9, 10, 15 and 16 have been rejected.

```
Name : TL 3Ch MF24      08/01/2010      10:06:01 AM

Type : 14 bit grey/pseudo
Intensity : 1.000000 lux
x : 1004 * 0.196078 : um
y : 1002 * 0.211172 : um
XY : 5
Well : 20

[Created]
Date=08/01/2010
Time=9:57:08 AM

[Created End]

[XYZScan]
ScanName=Multi Well 6x4 5SysSampling
FileVersion=2
Centre=False
Channel=
WellPattern=6x4 2mm-2.5mm plate
Density=5
Calibration=Manual
XYFields=100      8691,15017,124.83 9165,15017,124.83 8691,15724,124.83 9165,15724,124.83
9639,15724,124.83 11190.2140559637,14954.3174468164,124.83
11664.2140559637,14954.3174468164,95.67      11190.2140559637,15661.3174468164,95.67
11664.2140559637,15661.3174468164,95.67      12138.2140559637,15661.3174468164,95.67
13689.4281119273,14891.6348936329,120.67      14163.4281119273,14891.6348936329,120.67
13689.4281119273,15598.6348936329,120.67      14163.4281119273,15598.6348936329,120.67
14637.4281119273,15598.6348936329,120.67      16188.642167891,14828.9523404493,104
16662.642167891,14828.9523404493,116.5      16188.642167891,15535.8523404493,120.67
16662.642167891,15535.8523404493,119.32      17136.642167891,15535.8523404493,87.34
18687.8562238547,14766.2697872658,116.5      19161.8562238547,14766.2697872658,116.5
18687.8562238547,15473.2697872658,116.5      19161.8562238547,15473.2697872658,116.5
19635.8562238547,15473.2697872658,116.5      21187.0702798184,14703.5872340822,112.34
21661.0702798184,14703.5872340822,112.34      21187.0702798184,15410.5872340822,112.34
21661.0702798184,15410.5872340822,112.34      22135.0702798184,15410.5872340822,112.34
8753.68255318356,17516.2140559637,133.17      9227.68255318356,17516.2140559637,133.17
8753.68255318356,18223.2140559637,133.17      9227.68255318356,18223.2140559637,133.17
```

```

9701.68255318356,18223.2140559637,133.17 11252.8966091472,17453.5315027801,133.17
11726.8966091472,17453.5315027801,133.17 11252.8966091472,18160.5315027801,133.17
11726.8966091472,18160.5315027801,133.17 12200.8966091472,18160.5315027801,133.17
18750.5387770383,17265.4838432294,120.67 19224.5387770383,17265.4838432294,120.67
18750.5387770383,17972.4838432294,120.67 19224.5387770383,17972.4838432294,120.67
19698.5387770383,17972.4838432294,120.67 21249.7528330019,17202.8012900459,120.67
21723.7528330019,17202.8012900459,116.5 21249.7528330019,17909.8012900459,116.5
21723.7528330019,17909.8012900459,116.5 22197.7528330019,17909.8012900459,116.5
8816.36510636712,20015.4281119273,137.33 9290.36510636712,20015.4281119273,137.33
8816.36510636712,20722.4281119273,137.33 9290.36510636712,20722.4281119273,137.33
9764.36510636712,20722.4281119273,141.5 11315.5791623308,19952.7455587438,137.33
11789.5791623308,19952.7455587438,137.33 11315.5791623308,20659.7455587438,137.33
11789.5791623308,20659.7455587438,137.33 12263.5791623308,20659.7455587438,137.33
18813.2213302218,19764.6978991931,129 19287.2213302218,19764.6978991931,129
18813.2213302218,20471.6978991931,129 19287.2213302218,20471.6978991931,129
19761.2213302218,20471.6978991931,129 21312.4353861855,19702.0153460095,124.83
21786.4353861855,19702.0153460095,124.83 21312.4353861855,20409.0153460095,124.83
21786.4353861855,20409.0153460095,124.83 22260.4353861855,20409.0153460095,124.83
8879.04765955069,22514.642167891,124.83 9353.04765955069,22514.642167891,124.83
8879.04765955069,23221.642167891,129 9353.04765955069,23221.642167891,129
9827.04765955069,23221.642167891,129 11378.2617155144,22451.9596147075,120.67
11852.2617155144,22451.9596147075,120.67 11378.2617155144,23158.9596147075,145.67
11852.2617155144,23158.9596147075,145.67 12326.2617155144,23158.9596147075,120.67
13877.475771478,22389.2770615239,112.34 14351.475771478,22389.2770615239,112.34
13877.475771478,23096.2770615239,116.5 14351.475771478,23096.2770615239,112.34
14825.475771478,23096.2770615239,112.34 16376.6898274417,22326.5945083403,108.17
16850.6898274417,22326.5945083403,108.17 16376.6898274417,23033.5945083403,108.17
16850.6898274417,23033.5945083403,108.17 17324.6898274417,23033.5945083403,108.17
18875.8038834054,22263.9119551568,104 19349.9038834054,22263.9119551568,104
18875.8038834054,22970.9119551568,104 19349.9038834054,22970.9119551568,104
19823.9038834054,22970.9119551568,104 21375.107939369,22201.2294019732,137.33
21849.117939369,22201.2294019732,129.79 21375.107939369,22908.2294019732,137.33
21849.117939369,22908.2294019732,137.33 22323.117939369,22908.2294019732,137.33

ZScan=

Montage=

Plates=1 7998,14489.1,8121.6,14486,[9,10,15,16],1

MontageOffsets=

[XYZScan End]

[Region Info (Fields) Field]

Width=196.862745

Height=211.594005

[Region Info (Fields) Field End]

[Region Info (Fields)]

100 5 RegionData6.0 08/01/2010 9:58:14 AM

Class Name Class Colour Position X Position Y Position Z

Fields 32768 8691.000000 15017.000000

124.830000

Fields 32768 9165.000000 15017.000000

124.830000

Fields 32768 8691.000000 15724.000000

124.830000

Fields 32768 9165.000000 15724.000000

124.830000

```

Andor iQ USER GUIDE

Fields	32768	9639.000000	15724.000000
124.830000			
Fields	32768	11190.214056	14954.317447
124.830000			
Fields	32768	11664.214056	14954.317447
95.670000			
Fields	32768	11190.214056	15661.317447
95.670000			
Fields	32768	11664.214056	15661.317447
95.670000			
Fields	32768	12138.214056	15661.317447
95.670000			
Fields	32768	13689.428112	14891.634894
120.670000			
Fields	32768	14163.428112	14891.634894
120.670000			
Fields	32768	13689.428112	15598.634894
120.670000			
Fields	32768	14163.428112	15598.634894
120.670000			
Fields	32768	14637.428112	15598.634894
120.670000			
Fields	32768	16188.642168	14828.952340
104.000000			
Fields	32768	16662.642168	14828.952340
116.500000			
Fields	32768	16188.642168	15535.852340
120.670000			
Fields	32768	16662.642168	15535.852340
119.320000			
Fields	32768	17136.642168	15535.852340
87.340000			
Fields	32768	18687.856224	14766.269787
116.500000			
Fields	32768	19161.856224	14766.269787
116.500000			

Andor iQ USER GUIDE

Fields	32768	18687.856224	15473.269787
116.500000			
Fields	32768	19161.856224	15473.269787
116.500000			
Fields	32768	19635.856224	15473.269787
116.500000			
Fields	32768	21187.070280	14703.587234
112.340000			
Fields	32768	21661.070280	14703.587234
112.340000			
Fields	32768	21187.070280	15410.587234
112.340000			
Fields	32768	21661.070280	15410.587234
112.340000			
Fields	32768	22135.070280	15410.587234
112.340000			
Fields	32768	8753.682553	17516.214056
133.170000			
Fields	32768	9227.682553	17516.214056
133.170000			
Fields	32768	8753.682553	18223.214056
133.170000			
Fields	32768	9227.682553	18223.214056
133.170000			
Fields	32768	9701.682553	18223.214056
133.170000			
Fields	32768	11252.896609	17453.531503
133.170000			
Fields	32768	11726.896609	17453.531503
133.170000			
Fields	32768	11252.896609	18160.531503
133.170000			
Fields	32768	11726.896609	18160.531503
133.170000			
Fields	32768	12200.896609	18160.531503
133.170000			

Andor iQ USER GUIDE

Fields	32768	18750.538777	17265.483843
120.670000			
Fields	32768	19224.538777	17265.483843
120.670000			
Fields	32768	18750.538777	17972.483843
120.670000			
Fields	32768	19224.538777	17972.483843
120.670000			
Fields	32768	19698.538777	17972.483843
120.670000			
Fields	32768	21249.752833	17202.801290
120.670000			
Fields	32768	21723.752833	17202.801290
116.500000			
Fields	32768	21249.752833	17909.801290
116.500000			
Fields	32768	21723.752833	17909.801290
116.500000			
Fields	32768	22197.752833	17909.801290
116.500000			
Fields	32768	8816.365106	20015.428112
137.330000			
Fields	32768	9290.365106	20015.428112
137.330000			
Fields	32768	8816.365106	20722.428112
137.330000			
Fields	32768	9290.365106	20722.428112
137.330000			
Fields	32768	9764.365106	20722.428112
141.500000			
Fields	32768	11315.579162	19952.745559
137.330000			
Fields	32768	11789.579162	19952.745559
137.330000			
Fields	32768	11315.579162	20659.745559
137.330000			

Andor iQ USER GUIDE

Fields	32768	11789.579162	20659.745559
137.330000			
Fields	32768	12263.579162	20659.745559
137.330000			
Fields	32768	18813.221330	19764.697899
129.000000			
Fields	32768	19287.221330	19764.697899
129.000000			
Fields	32768	18813.221330	20471.697899
129.000000			
Fields	32768	19287.221330	20471.697899
129.000000			
Fields	32768	19761.221330	20471.697899
129.000000			
Fields	32768	21312.435386	19702.015346
124.830000			
Fields	32768	21786.435386	19702.015346
124.830000			
Fields	32768	21312.435386	20409.015346
124.830000			
Fields	32768	21786.435386	20409.015346
124.830000			
Fields	32768	22260.435386	20409.015346
124.830000			
Fields	32768	8879.047660	22514.642168
124.830000			
Fields	32768	9353.047660	22514.642168
124.830000			
Fields	32768	8879.047660	23221.642168
129.000000			
Fields	32768	9353.047660	23221.642168
129.000000			
Fields	32768	9827.047660	23221.642168
129.000000			
Fields	32768	11378.261716	22451.959615
120.670000			

Andor iQ USER GUIDE

Fields	32768	11852.261716	22451.959615
120.670000			
Fields	32768	11378.261716	23158.959615
145.670000			
Fields	32768	11852.261716	23158.959615
145.670000			
Fields	32768	12326.261716	23158.959615
120.670000			
Fields	32768	13877.475771	22389.277062
112.340000			
Fields	32768	14351.475771	22389.277062
112.340000			
Fields	32768	13877.475771	23096.277062
116.500000			
Fields	32768	14351.475771	23096.277062
112.340000			
Fields	32768	14825.475771	23096.277062
112.340000			
Fields	32768	16376.689827	22326.594508
108.170000			
Fields	32768	16850.689827	22326.594508
108.170000			
Fields	32768	16376.689827	23033.594508
108.170000			
Fields	32768	16850.689827	23033.594508
108.170000			
Fields	32768	17324.689827	23033.594508
108.170000			
Fields	32768	18875.803883	22263.911955
104.000000			
Fields	32768	19349.903883	22263.911955
104.000000			
Fields	32768	18875.803883	22970.911955
104.000000			
Fields	32768	19349.903883	22970.911955
104.000000			

Fields	32768	19823.903883	22970.911955
104.000000			
Fields	32768	21375.107939	22201.229402
137.330000			
Fields	32768	21849.117939	22201.229402
129.790000			
Fields	32768	21375.107939	22908.229402
137.330000			
Fields	32768	21849.117939	22908.229402
137.330000			
Fields	32768	22323.117939	22908.229402
137.330000			
[Region Info (Fields) End]			
[Environment]			
User=iQ User			
Configuration=iMic-Luca			
[Environment End]			
[Protocol Description]			
Protocol - TL 3Ch MF			
Image - TL 3Ch MF			
Protocol Type - Time Series			
Camera Binning - Use Current			
Wait Allocation - Off			
Camera Selection - Use Current			
Events			
Keyboard Events - On			
Default name - Spacebar			
Scan - Multi Well 6x4 5SysSampling			
Pause - Click OK to start protocol			
Interval - 0 ms (fastest)			
Repeat - 1 times			
Repeat - Well			
Repeat - XY			
Sampling Density - 5			
Scan Pattern - 6x4 2mm-2.5mm plate			

Well 1	
	XY 1 - (8691,15017,124.83)
	XY 2 - (9165,15017,124.83)
	XY 3 - (8691,15724,124.83)
	XY 4 - (9165,15724,124.83)
	XY 5 - (9639,15724,124.83)
Well 2	
	XY 1 - (11190.214,14954.316,124.83)
	XY 2 - (11664.214,14954.316,95.67)
	XY 3 - (11190.214,15661.316,95.67)
	XY 4 - (11664.214,15661.316,95.67)
	XY 5 - (12138.214,15661.316,95.67)
Well 3	
	XY 1 - (13689.428,14891.635,120.67)
	XY 2 - (14163.428,14891.635,120.67)
	XY 3 - (13689.428,15598.635,120.67)
	XY 4 - (14163.428,15598.635,120.67)
	XY 5 - (14637.428,15598.635,120.67)
Well 4	
	XY 1 - (16188.642,14828.951,104)
	XY 2 - (16662.642,14828.951,116.5)
	XY 3 - (16188.642,15535.851,120.67)
	XY 4 - (16662.642,15535.851,119.31)
	XY 5 - (17136.642,15535.851,87.34)
Well 5	
	XY 1 - (18687.856,14766.27,116.5)
	XY 2 - (19161.856,14766.27,116.5)
	XY 3 - (18687.856,15473.27,116.5)
	XY 4 - (19161.856,15473.27,116.5)
	XY 5 - (19635.856,15473.27,116.5)
Well 6	
	XY 1 - (21187.07,14703.587,112.34)
	XY 2 - (21661.07,14703.587,112.34)
	XY 3 - (21187.07,15410.587,112.34)
	XY 4 - (21661.07,15410.587,112.34)
	XY 5 - (22135.07,15410.587,112.34)

Well 7	
	XY 1 - (8753.683,17516.214,133.16)
	XY 2 - (9227.683,17516.214,133.16)
	XY 3 - (8753.683,18223.214,133.16)
	XY 4 - (9227.683,18223.214,133.16)
	XY 5 - (9701.683,18223.214,133.16)
Well 8	
	XY 1 - (11252.897,17453.532,133.16)
	XY 2 - (11726.897,17453.532,133.16)
	XY 3 - (11252.897,18160.532,133.16)
	XY 4 - (11726.897,18160.532,133.16)
	XY 5 - (12200.897,18160.532,133.16)
Well 11	
	XY 1 - (18750.539,17265.484,120.67)
	XY 2 - (19224.539,17265.484,120.67)
	XY 3 - (18750.539,17972.484,120.67)
	XY 4 - (19224.539,17972.484,120.67)
	XY 5 - (19698.539,17972.484,120.67)
Well 12	
	XY 1 - (21249.753,17202.801,120.67)
	XY 2 - (21723.753,17202.801,116.5)
	XY 3 - (21249.753,17909.801,116.5)
	XY 4 - (21723.753,17909.801,116.5)
	XY 5 - (22197.753,17909.801,116.5)
Well 13	
	XY 1 - (8816.365,20015.428,137.33)
	XY 2 - (9290.365,20015.428,137.33)
	XY 3 - (8816.365,20722.428,137.33)
	XY 4 - (9290.365,20722.428,137.33)
	XY 5 - (9764.365,20722.428,141.5)
Well 14	
	XY 1 - (11315.579,19952.746,137.33)
	XY 2 - (11789.579,19952.746,137.33)
	XY 3 - (11315.579,20659.746,137.33)
	XY 4 - (11789.579,20659.746,137.33)
	XY 5 - (12263.579,20659.746,137.33)

Well 17

- XY 1 - (18813.221,19764.698,129)
- XY 2 - (19287.221,19764.698,129)
- XY 3 - (18813.221,20471.698,129)
- XY 4 - (19287.221,20471.698,129)
- XY 5 - (19761.221,20471.698,129)

Well 18

- XY 1 - (21312.435,19702.015,124.83)
- XY 2 - (21786.435,19702.015,124.83)
- XY 3 - (21312.435,20409.015,124.83)
- XY 4 - (21786.435,20409.015,124.83)
- XY 5 - (22260.435,20409.015,124.83)

Well 19

- XY 1 - (8879.048,22514.642,124.83)
- XY 2 - (9353.048,22514.642,124.83)
- XY 3 - (8879.048,23221.642,129)
- XY 4 - (9353.048,23221.642,129)
- XY 5 - (9827.048,23221.642,129)

Well 20

- XY 1 - (11378.262,22451.96,120.67)
- XY 2 - (11852.262,22451.96,120.67)
- XY 3 - (11378.262,23158.96,145.66)
- XY 4 - (11852.262,23158.96,145.66)
- XY 5 - (12326.262,23158.96,120.67)

Well 21

- XY 1 - (13877.476,22389.276,112.34)
- XY 2 - (14351.476,22389.276,112.34)
- XY 3 - (13877.476,23096.276,116.5)
- XY 4 - (14351.476,23096.276,112.34)
- XY 5 - (14825.476,23096.276,112.34)

Well 22

- XY 1 - (16376.69,22326.595,108.17)
- XY 2 - (16850.69,22326.595,108.17)
- XY 3 - (16376.69,23033.595,108.17)
- XY 4 - (16850.69,23033.595,108.17)
- XY 5 - (17324.69,23033.595,108.17)

```
Well 23
    XY 1 - (18875.804,22263.912,104)
    XY 2 - (19349.904,22263.912,104)
    XY 3 - (18875.804,22970.912,104)
    XY 4 - (19349.904,22970.912,104)
    XY 5 - (19823.904,22970.912,104)

Well 24
    XY 1 - (21375.107,22201.229,137.33)
    XY 2 - (21849.117,22201.229,129.78)
    XY 3 - (21375.107,22908.229,137.33)
    XY 4 - (21849.117,22908.229,137.33)
    XY 5 - (22323.117,22908.229,137.33)

Channel - Current
    Camera EM Gain - Current
    Camera Binning X - Current
    Camera Binning Y - Current
    Camera Exposure Time (s) - Current
    LUT - Current
    Map Min - Current
    Map Max - Current
    iMIC Filter Wheel 1 - Current
    iMIC Filter Wheel 2 - Current
    iMIC LED Shutter - Current
    iMIC Piezo Z Motor - Current
    iMIC TIRF Angle - Current

Snap
    End - XY
    End - Well
    End

[Protocol Description End]
[Grab Parameters]
Camera=Andor
Window Left=0
Window Top=0
Window Right=1003
```

Window Bottom=1001

Window Width=1004

Window Height=1002

BinningX=1

BinningY=1

Image Width=1004

Image Height=1002

Exposure=20000

[Grab Parameters End]

[Tab Device Info]

Camera=Luc285_MONO 574

ControllerCard=

DriverVersion=2.86.30001.0

CofVersion=0

VxDVersion=0.0

SoftwareTrigger=Supported

BitDepth=14

FPGA_Version=16.1

Ocx_Version=5.1.1.19

Ocx_Time=15:08:50 Dec 10 2009

Ocx_File=C:\PROGRA~1\ANDORB~1\COMMON~1\KIDAND~1.OCX

[Tab Device Info End]

[Tab Exposure]

Window=1004 : 1002

Shutter=Open

Binning=1x1

Temperature - Actual =-20

Display Control - Fastest=Checked

Display Control - Display Rate=1

Gains - Pre-Amp-Gain=1.00

EM Gain - Enabled=Unchecked

Gains - EMGain=21

Exposure Time - Frame Transfer=Unchecked

Exposure Time - unit=ms

Exposure Time - exposure value=20.00

Exposure Time - Actual=20.000ms
Exposure Time - Readout in ms=80.644
Experiment Control - FLZ=Unchecked
Experiment Control - Trig Mode=Free Run
Experiment Control - Ext Start=Unchecked
Use Frame averaging=Unchecked
Frames to be averaged=1
Fastest Grab=Unchecked
Available memory=1476

[Tab Exposure End]

[Tab Temperature/Shutter]

Temperature Setting=-20
Actual Temperature=-20
Cooling=Steady
Fan=Full
TTL High Open=Checked
Shutter Open Transfer Time=60
Shutter Close Transfer Time=80

[Tab Temperature/Shutter End]

[Tab Speed/Amplifier]

Horizontal Readout=12.500
Vertical Readout time=0.889
ADC Channel=0
Vertical Clock Voltage=Normal
Output Amplifier=EM Port
Baseline Clamp=Unchecked

[Tab Speed/Amplifier End]

[Tab Image Orientation]

Flip=Vertical
Rotation in Degrees=None

[Tab Image Orientation End]

[Image Info]

Window Left=0
Window Top=0
Window Right=1003
Window Bottom=1001

```
Window Width=1004
Window Height=1002
Window BinningX=1
Window BinningY=1
[Image Info End]
[Image Bits]
14 Bit Data=TRUE
[Image Bits End]
[First Frame]
SavedTime=1/8/2010 9:57:09 AM.15
[First Frame End]
```

2. This example contains the header of a 2 fields, 3 by 3 montage image with 10 z steps per montage tile.

```
Name : TL 3Ch MF26      08/01/2010      10:44:23 AM

Type : 14 bit grey/pseudo
Intensity : 1.000000 lux
x : 1004 * 0.196078 : um
y : 1002 * 0.211172 : um
Z : 10
Montage : 9
XY : 2

[Created]
Date=08/01/2010
Time=10:35:35 AM
[Created End]
[XYZScan]
ScanName=3MFMontageZScan
FileVersion=2
Centre=False
```

```

Channel=
WellPattern=
Density=0
Calibration=
XYFields=2      16168.142,16935.022,116.66,YZSTEP0  15499.316,15636.097,112.5,YZSTEP0
ZScan=STEP6.02  10
Montage=Region  Overlap 5 Width 570.901960784314  Height 613.622615803816  Units Fields
Plates=
MontageOffsets=9  -187.019607843137,-201.014305177112,0      0,-201.014305177112,0
                  187.019607843137,-201.014305177112,0      -187.019607843137,0,0      0,0,0
                  187.019607843137,0,0      -187.019607843137,201.014305177112,0      0,201.014305177112,0
                  187.019607843137,201.014305177112,0
[XYZScan End]
[Region Info (Fields) Field]
Width=196.862745
Height=211.594005
[Region Info (Fields) Field End]
[Region Info (Fields)]
18      5      RegionData6.0      08/01/2010      10:43:13 AM
Class Name      Class Colour      Position X Position Y Position Z
Fields  32768  15981.122392      16734.007695
116.660000
Fields  32768  16161.945921      16720.915052
116.660000
Fields  32768  16355.161608      16734.007695
116.660000
Fields  32768  15981.122392      16935.022000
116.660000
Fields  32768  16168.142000      16935.022000
116.660000
Fields  32768  16355.161608      16935.022000
116.660000
Fields  32768  15981.122392      17136.036305
116.660000
Fields  32768  16168.142000      17136.036305
116.660000
Fields  32768  16355.161608      17136.036305
    
```

116.660000			
Fields	32768	15312.296392	15435.082695
112.500000			
Fields	32768	15499.316000	15435.082695
112.500000			
Fields	32768	15686.335608	15435.082695
112.500000			
Fields	32768	15312.296392	15636.097000
112.500000			
Fields	32768	15499.316000	15636.097000
112.500000			
Fields	32768	15686.335608	15636.097000
112.500000			
Fields	32768	15312.296392	15837.111305
112.500000			
Fields	32768	15499.316000	15837.111305
112.500000			
Fields	32768	15686.335608	15837.111305
112.500000			
[Region Info (Fields) End]			
[Environment]			
User=iQ User			
Configuration=iMic-Luca			
[Environment End]			
[Protocol Description]			
Protocol - TL 3Ch MF			
Image - TL 3Ch MF			
Protocol Type - Time Series			
Camera Binning - Use Current			
Wait Allocation - Off			
Camera Selection - Use Current			
Events			
Keyboard Events - On			
Default name - Spacebar			

```
Scan - 3MFMontageZScan
Montage Acquisition - XYZ ()
Centre on Registration - XYZ ()
Pause - Click OK to start protocol
Interval - 0 ms (fastest)
Repeat - 1 times
    Repeat - XY
        Repeat - Montage
            Repeat - Z
                Z - 54.18 um in 10 planes
                Montage Positions (9 ( 3 by 3 ))
                XY Positions (2)
                    XY 1 - (16168.142,16935.022,116.66)
                    XY 2 - (15499.316,15636.097,112.5)
                Channel - Current
                    Camera EM Gain - Current
                    Camera Binning X - Current
                    Camera Binning Y - Current
                    Camera Exposure Time (s) - Current
                    LUT - Current
                    Map Min - Current
                    Map Max - Current
                    iMIC Filter Wheel 1 - Current
                    iMIC Filter Wheel 2 - Current
                    iMIC LED Shutter - Current
                    iMIC Piezo Z Motor - Current
                    iMIC TIRF Angle - Current
            Snap
        End - Z
    End - Montage
End - XY
End
```

[Protocol Description End]

[Grab Parameters]

```
Camera=Andor
Window Left=0
Window Top=0
Window Right=1003
Window Bottom=1001
Window Width=1004
Window Height=1002
BinningX=1
BinningY=1
Image Width=1004
Image Height=1002
Exposure=20000
[Grab Parameters End]
[Tab Device Info]
Camera=Luc285_MONO 574
ControllerCard=
DriverVersion=2.86.30001.0
CofVersion=0
VxDVersion=0.0
SoftwareTrigger=Supported
BitDepth=14
FPGA_Version=16.1
Ocx_Version=5.1.1.19
Ocx_Time=15:08:50 Dec 10 2009
Ocx_File=C:\PROGRA~1\ANDORB~1\COMMON~1\KIDAND~1.OCX
[Tab Device Info End]
[Tab Exposure]
Window=1004 : 1002
Shutter=Open
Binning=1x1
Temperature - Actual =-20
Display Control - Fastest=Checked
Display Control - Display Rate=1
Gains - Pre-Amp-Gain=1.00
```

EM Gain - Enabled=Unchecked
Gains - EMGain=21
Exposure Time - Frame Transfer=Unchecked
Exposure Time - unit=ms
Exposure Time - exposure value=20.00
Exposure Time - Actual=20.000ms
Exposure Time - Readout in ms=80.644
Experiment Control - FLZ=Unchecked
Experiment Control - Trig Mode=Free Run
Experiment Control - Ext Start=Unchecked
Use Frame averaging=Unchecked
Frames to be averaged=1
Fastest Grab=Unchecked
Available memory=1459
[Tab Exposure End]
[Tab Temperature/Shutter]
Temperature Setting=-20
Actual Temperature=-20
Cooling=Steady
Fan=Full
TTL High Open=Checked
Shutter Open Transfer Time=60
Shutter Close Transfer Time=80
[Tab Temperature/Shutter End]
[Tab Speed/Amplifier]
Horizontal Readout=12.500
Vertical Readout time=0.889
ADC Channel=0
Vertical Clock Voltage=Normal

Output Amplifier=EM Port
Baseline Clamp=Unchecked
[Tab Speed/Amplifier End]
[Tab Image Orientation]
Flip=Vertical

Rotation in Degrees=None

[Tab Image Orientation End]

[Image Info]

Window Left=0

Window Top=0

Window Right=1003

Window Bottom=1001

Window Width=1004

Window Height=1002

Window BinningX=1

Window BinningY=1

[Image Info End]

[Image Bits]

14 Bit Data=TRUE

[Image Bits End]

[First Frame]

SavedTime=1/8/2010 10:35:36 AM.31

[First Frame End]

[Montage]

Adjusted=true

[Montage End]



Appendix 5 – How To Documents

A5.1. How to Set Up a Channel

1. Select **Channels** from the Wizards menu or from the Acquisition tab click the **Channel button** to open the Channel Manager.



2. Select **New** to create a new Channel.

3. Enter a name for the new Channel and Press **Next** to continue.

4. Select the appropriate Filter Wheel and Shutter positions and press **Next** to continue.

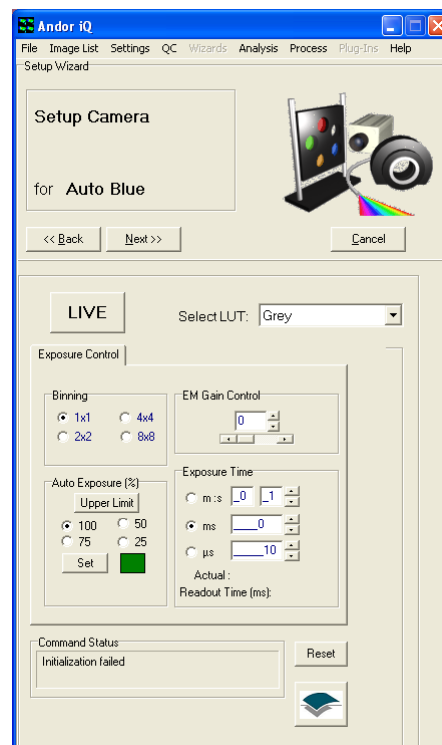
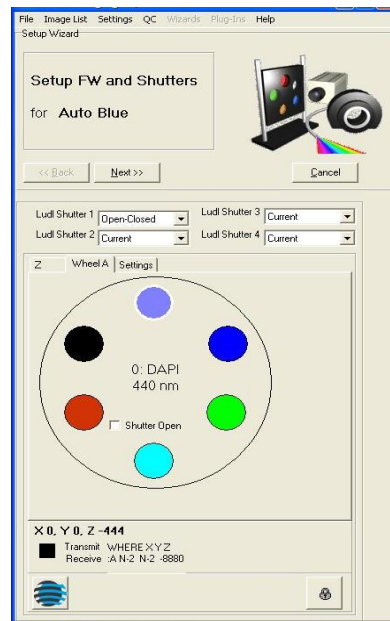

5. Set up the Camera settings by choosing the Look up Table (LUT) associated with the Channel.

6. Select the Binning and Auto Exposure then adjust the Gain Control until the desired image quality has been reached.

Press **Next** to continue.

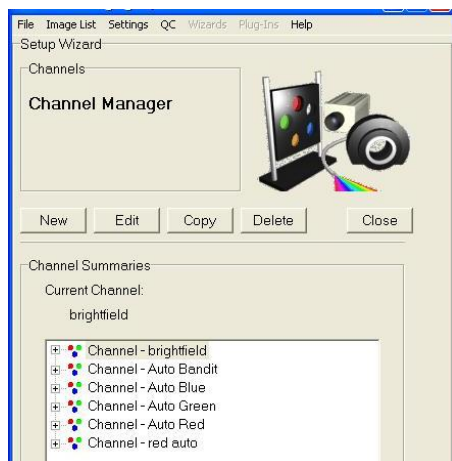

The new Channel will be listed in the Channel Summaries and available for use in Protocol setup.

Press **Close** to exit the Channel Manager.

A5.2. How to Set Up a Multi-field Scan

1. Select Scan from the Acquisition Tab or the File Menu to open the Scan Manager.

2. Select New to create a new scan. Enter a name for the new scan.

3. Select Multi-field Scan option.

4. Check centre on Registration Point if you need to use a reference point on the slide/well.

Press Next to continue.



5. Select Channel to go live with for Scan setup.

Press **Next** to continue.

6. Type the desired Number of Fields into the text box.

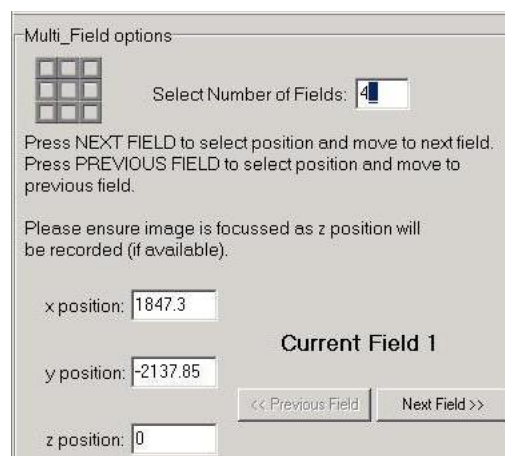

7. Set up Multi-Field Options by moving stage to desired location and selecting **Next Field**. Continue until all fields have been selected.

Next Field will change to **Finish** for the last Field Setting.



8. New Scan is then added to the list under Scan Manager and can be selected in setting up protocols.

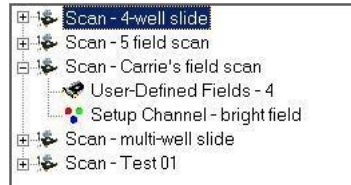

A5.3. How to Set Up a Z Series Scan

1. Select **Scan** from the Acquisition Tab or the File Menu to open the Scan Manager.

2. Select **New** to create a new scan.

3. Select **Z Series Scan** option.

4. Enter a name for the new scan.

Press **Next** to continue.

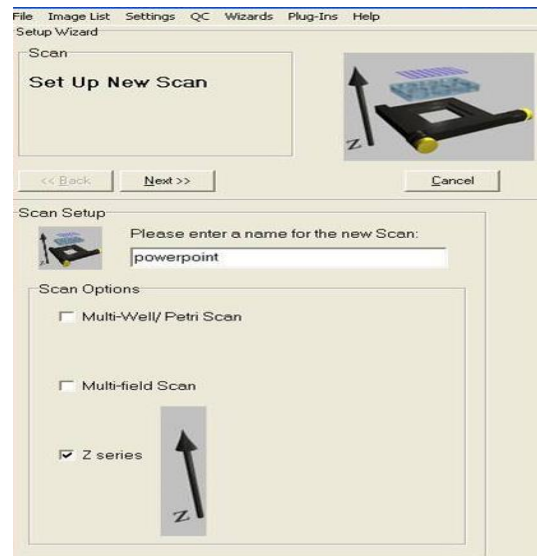

5. Select Channel to go live with for Scan setup. iQ will use the Last Channel in use.

Press **Next** to continue.

6. Under the Z Series options Select the Start and End point for the Z scan. Also, choose one of the Stack Definition parameters - ΔZ , Number of planes, or End Position.

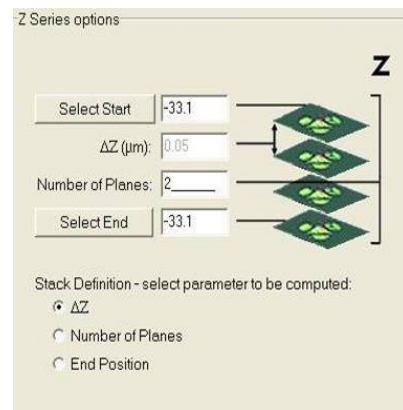

Press **Next** to continue

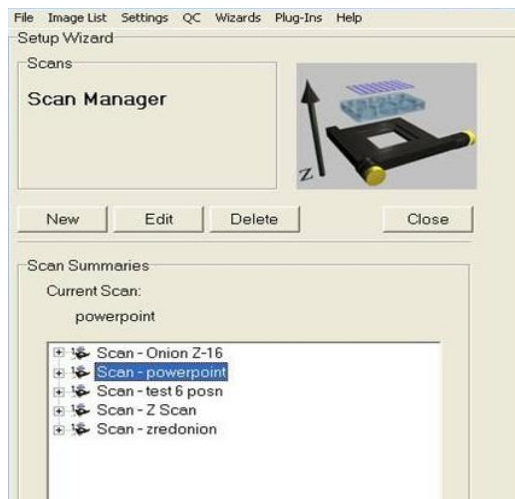

New Scan is then added to the list under Scan Manager and can be selected in setting up protocols.

A5.4. How to Set Up a Prototype Protocol

1. Select **Protocols** from the Wizards menu or from the Acquisition tab click the **Protocol button** to open the Protocol Manager.

2. Select **New** to create a new Protocol.

3. Enter a name for the new Protocol.

4. Choose the **Fast** option if you plan to use the Protocol with **Fast LZ** or with Fast Time (single Channel streaming)



5. When you Click OK the Prototype Protocol will be generated and you can then Edit with the right mouse menu options.

6. Right Mouse allows you to Insert Channels and Scans and Edit Repeat and Interval options.

Try the right mouse on all Protocol entries for a full range of options.

A5.5. How to Change the Sampling Rate on the Fly

1. When Protocol has been selected and the **Run** button has been pressed, the nD Protocol tree will appear under the Acquisition Tab in the Control Window.

2. Make sure the Tree is expanded and Right Click on **Interval**. In the picture the Interval is currently reading 500 ms.

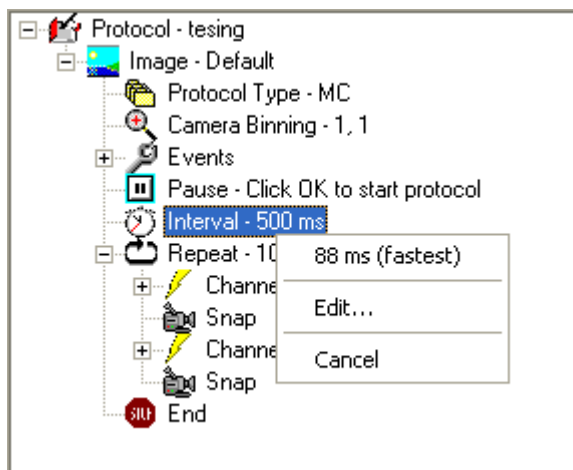

3. The right mouse click brings up the Menu on the right. Please note that acquisition will **PAUSE** during this process.

4. The first option is **88 ms (fastest)**. This is the fastest possible speed the protocol can run with the existing hardware configuration.

5. The Second option is **Edit...** This brings up the Edit interval length: Type in what you would like to change the interval to and select the unit of measure from the drop down list.

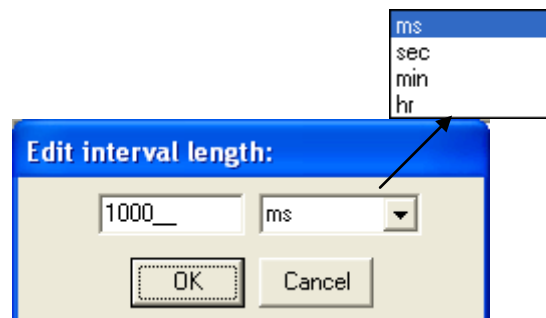

Andor iQ How To Documents

6. Select **Cancel** to exit and allow Acquisition to continue.

7. The new Interval Setting will now appear in the nD Protocol Tree and Acquisition will resume.

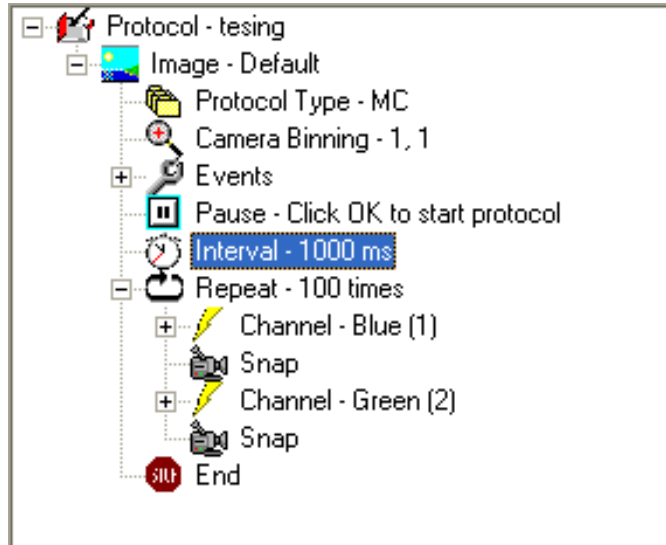

A5.6. How to Use “Load a Protocol”

1. Select the Protocol. Make sure the nD Protocol Tree is expanded in the Acquisition Tab of the Control Window.

2. Right Click End at the bottom of the nD Protocol Tree and the Insert button will appear.

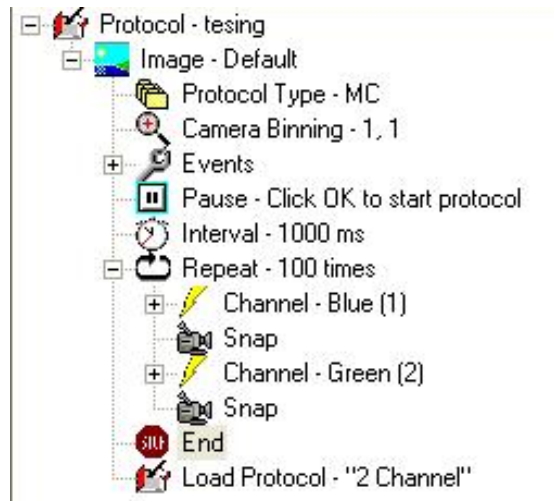

3. After selecting Insert, the Insert Item Window will appear. Select Load Protocol from the List and press the OK button. Press Cancel to exit at any time.

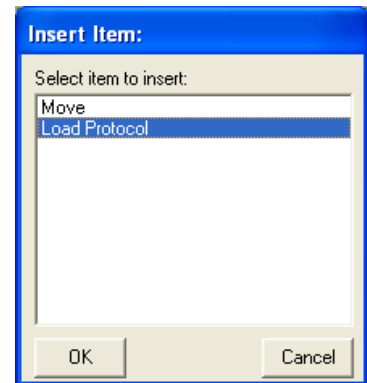

4. After Selecting OK, the Select Protocol window will open. All available protocols will appear in the list. Use the + button to expand the details of the protocol.

Highlight the protocol you wish to use and press Select. Press Cancel at any time to exit.

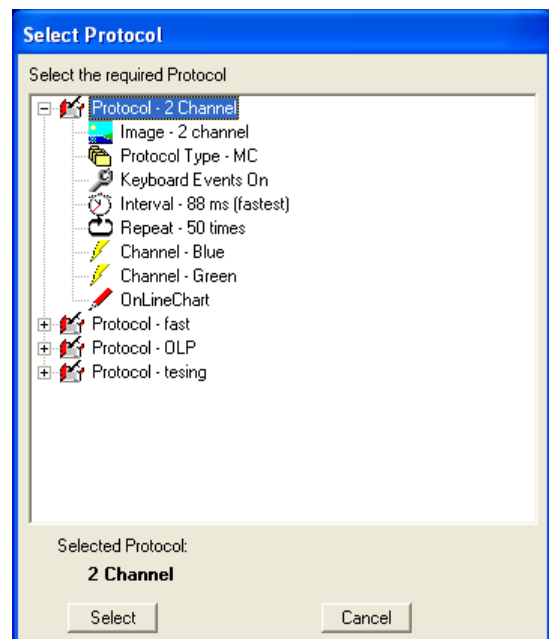

Note: The Protocol you want to run must be set up through the Protocol Wizard prior to trying to insert and load into another protocol.

5. Once selected, Load Protocol along with the name of the Protocol will be added to the nD Protocol Tree under the Acquisition Tab (see example on the left).

A5.7. How to On-Line Chart During Acquisition

1. Insert an OnLineChart node into the nD protocol tree. OnLineChart node can only be inserted on a Snap node.

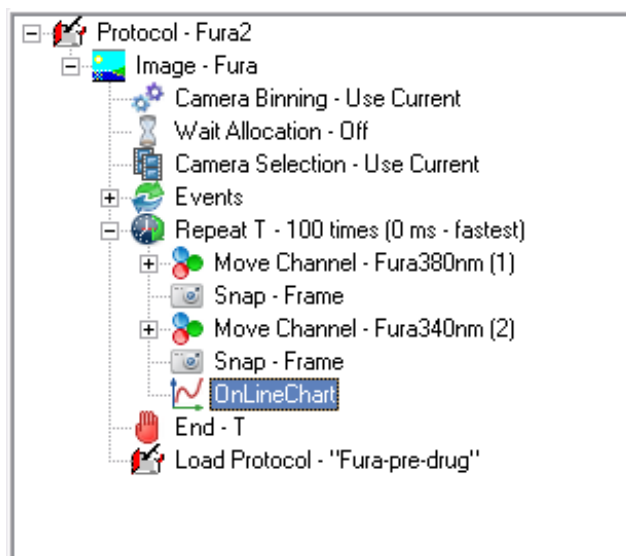

2. The Chart Options window will appear allowing you to select which channel you want to be displayed on the chart.

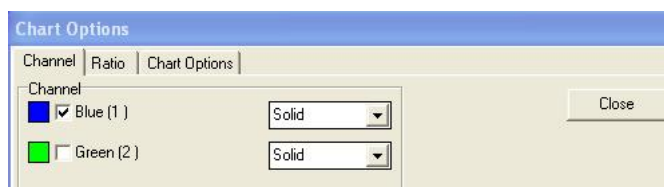

The chart can display a ratio of the channels if you run a multi channel experiment. Use the Ratio tab to select which channel to use as denominator and numerator.

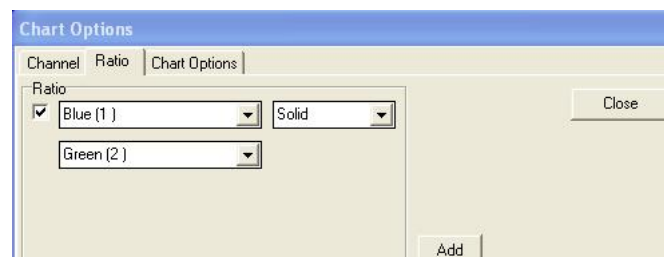

The **Add** button allows you to choose different types of ratios.

Additional settings are available on the third tab as shown here.

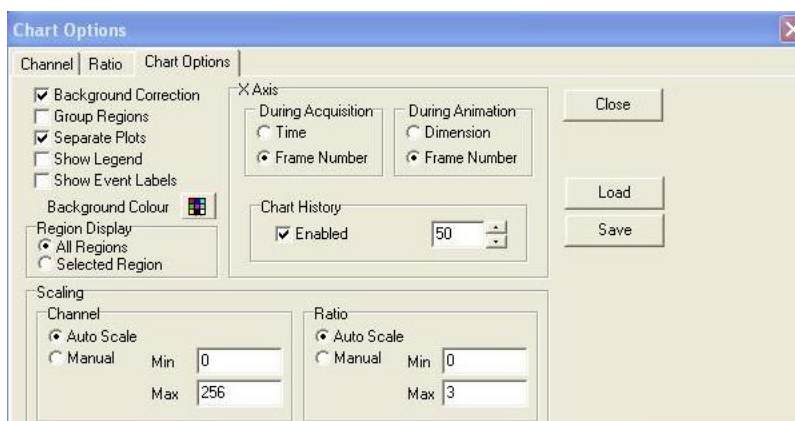

3. Press the Close button once you have finished setting the Chart. You can come back to those settings later on by right-clicking the OnLineChart node in the tree and selecting **Edit**. Settings will be saved with the protocol.

Note: Do not use the Chart Image plug-in (available from the View menu) to update the On-line Chart settings. Those settings won't be used during experiment.

4. Run the experiment. The Chart will be shown and display the curves automatically.

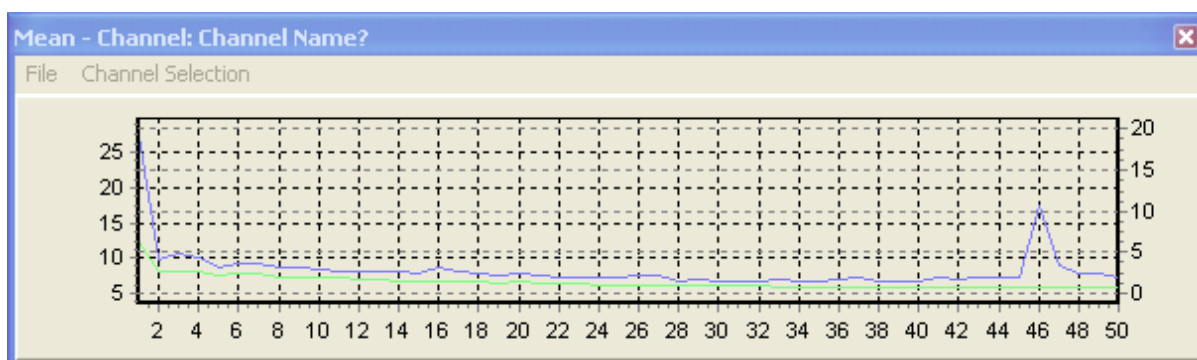

Note: Once the experiment is finished, using the navigator at the bottom of the Image View to explore the acquired data set will automatically add new data points to the chart.

A5.8. How to Open an Image (TIFF)

1. Select **Open Image** from the File menu in either the iQ control window or the image window.

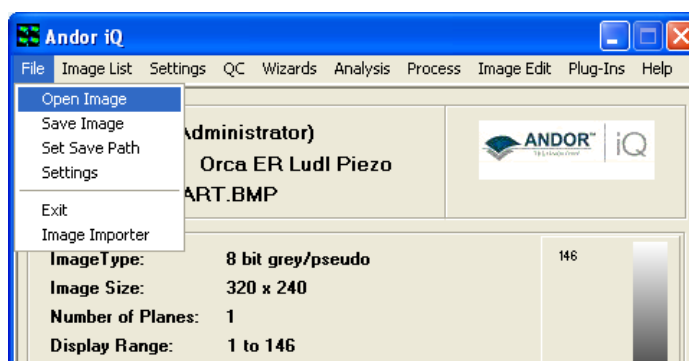

2. This will open the File Browser window. Select the drive and folder in which the images are located. By default, iQ will look for TIFF files. If you wish to open images of a different type, use the dropdown menu **Files of type**.

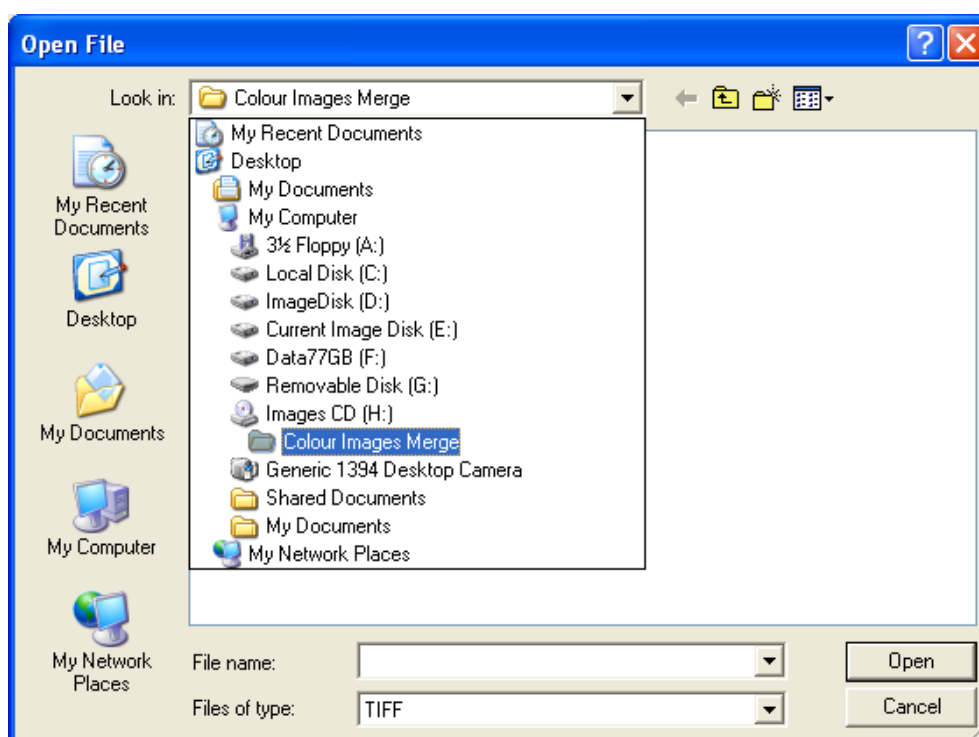

3. Select the file and click the **Open** button. The image will appear in the iQ Image Window and also the ImageDisk.

A5.9. How to Import Multi-dimensional Images Part 1

1. If the files to be opened have a unique, identifiable naming system for each dimension (specifically, a numerical system, `_z` to indicate z dimension, `_w` to indicate wavelength or `_t` to indicate time), select **Open Image** from the File menu in either the iQ control window or the image window.

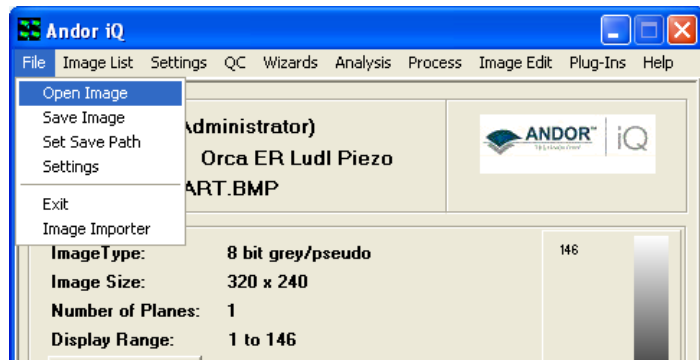

2. This will open the File Browser window. Select the drive and folder in which the images are located. By default, iQ will look for TIFF files. Select **Multi-Load (*.*)** from the dropdown menu **Files of type**.

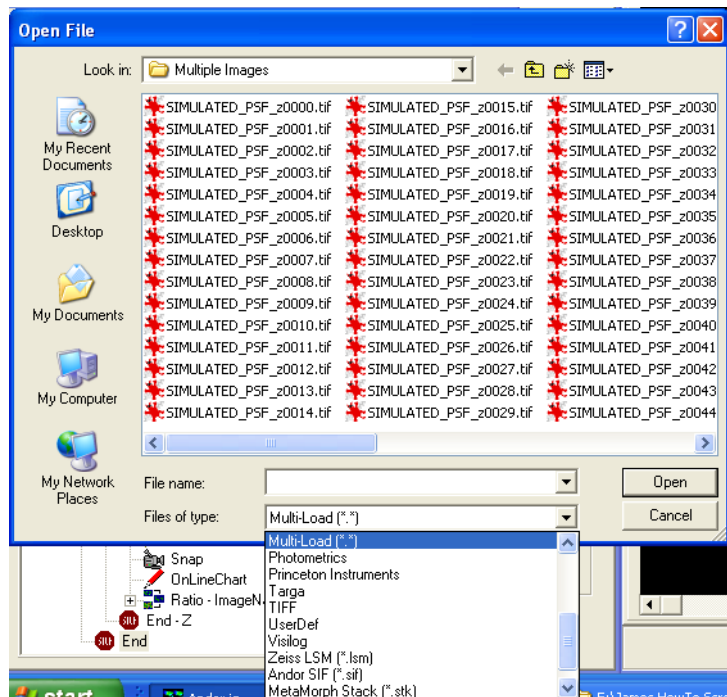

3. Select the first file in the series, in this case `SIMULATED_PSF_z0000.tif`, and click **Open**.

4. The files will be opened as a multi-dimensional image in iQ.

5. If the files to be opened do not have a naming system outlined above, but do have a common name, it may be possible for them to be imported more interactively using the **Image Importer Wizard**.

A5.10. How to Import Multi-dimensional Images Part 2

1. Select **Image Importer** from the File menu.

2. Using the  button, browse to the drive and directory of the files to be imported.

3. Enter a name that is common to all the files to be imported. Click **Next**.

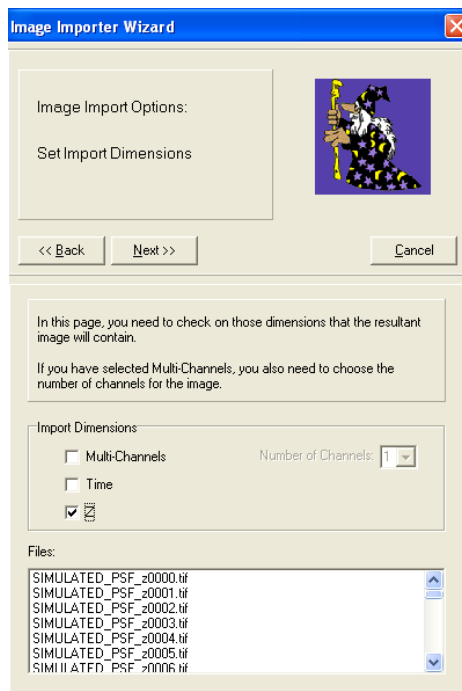
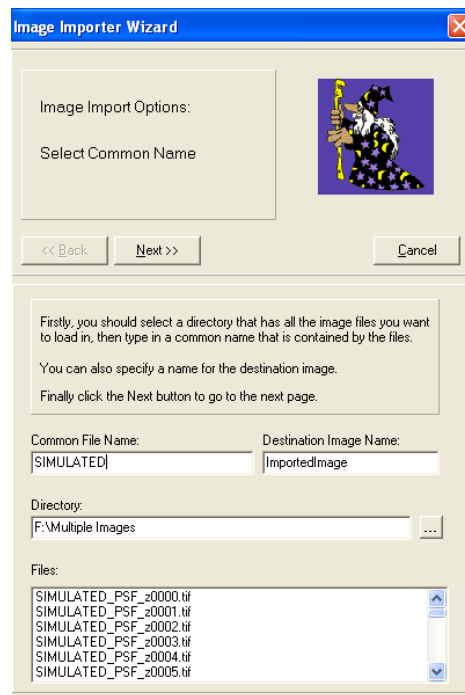

4. Now the dimensions of the imported

image must be specified. In this case, the image consists of only a Z dimension. Click **Next**.

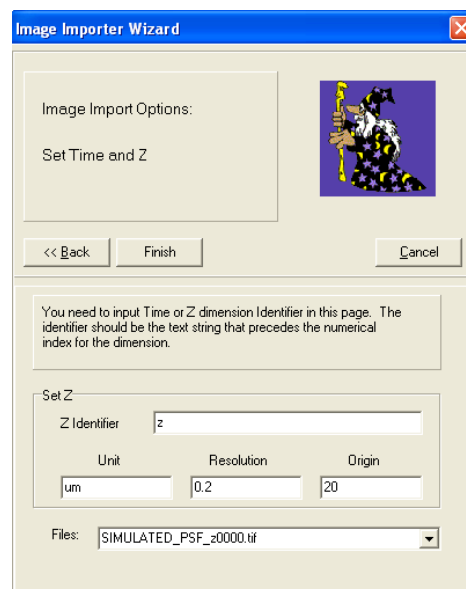

5. To complete the process, enter the unique dimension identifier for each dimension. In this case, 'z' will suffice because this is unique to the z dimension. The units, resolution and origin may also be specified, although this is not necessary to import the image. Click **Finish**.

A5.11. How to Adjust the File Size Limit

1. Select **Settings** from the File menu in the iQ Control Window.

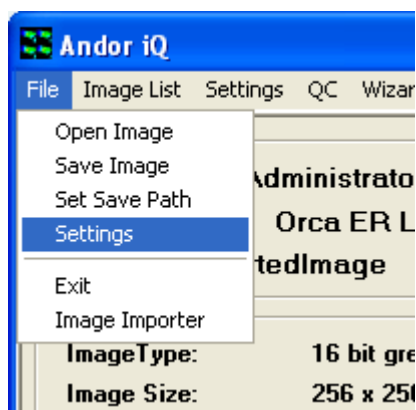

2. The following dialogue box will appear:

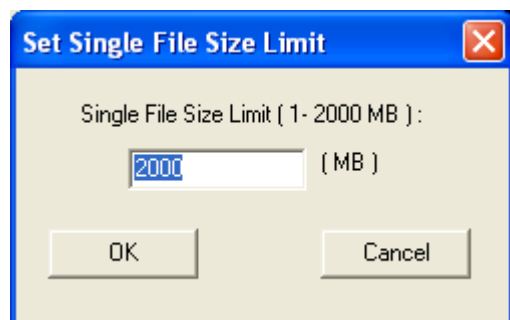

3. Enter a new maximum file size and click **OK**. Click **Cancel** to close the window without making any changes.

The maximum single file size supported by iQ under Windows (32 bit versions) is 2000 MB. This is for performance reasons. Should you wish to write images to a CD easily, for example, this file limit can be changed to 700 MB (for 80 minute CDs) or 650 MB (for 74 minute CDs). iQ will automatically split files saved out from the ImageDisk into files up to the specified single file size limit.

There are practical limitations with too small a limit, for example each single image from a camera could be over 1MB in size.

A5.12. Saving Multiple Images from the ImageDisk

1. Select ImageDisk from either the iQ Control Window, or the Image Window.

2. The Image Manager window will appear.

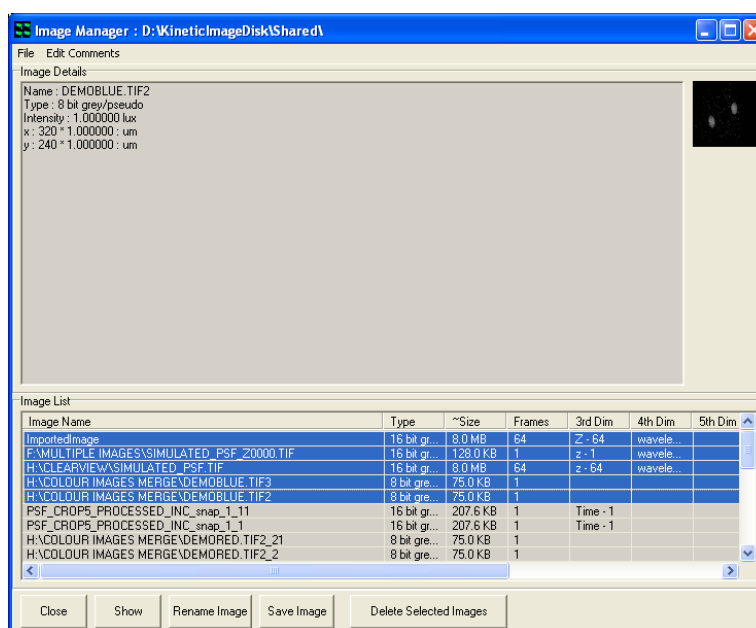

3. Highlight a file you wish to save by clicking on its name.

To highlight more than one file, hold CTRL on the keyboard and click on another file to highlight both files. To select a block of

contiguous files, select the first file, then hold SHIFT and click the last file in the block.

3. Click Save Image.

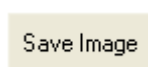

4. The Multiple File Save window will be displayed, asking if you wish for files to be deleted from the ImageDisk once they have been saved. Clicking

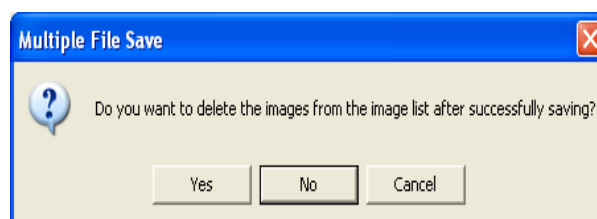

No to this dialogue would mean they remain in the ImageDisk AND are saved out to another directory. Clicking Yes would be a good way of ensuring the ImageDisk does not become too full over time.

Andor iQ How To Documents

5. Clicking Yes or No will produce a File Browser window, in which the destination drive and folder is selected. Once the destination has been chosen, clicking OK will complete the saving of the files from the ImageDisk. The files will be saved in TIFF format.

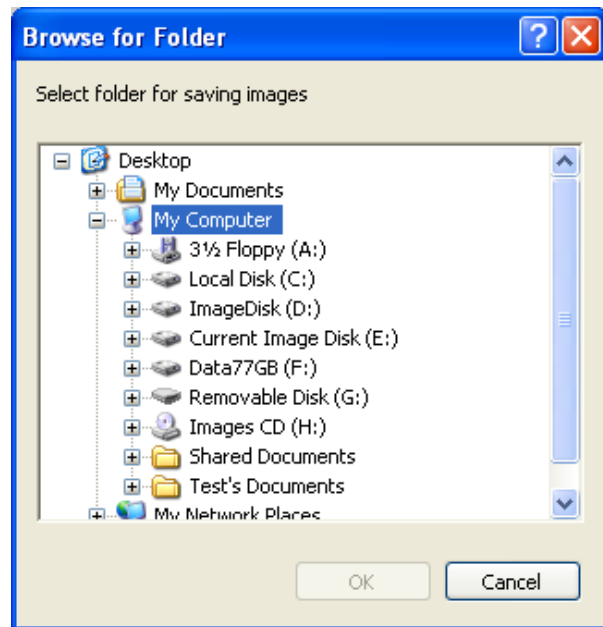

A5.13. How to Save JPEG or BMP Images

1. To save the currently loaded image, select **Save Display (JPEG or BMP)** from the File menu in the Image Window.

2. There are four options: **Region**, **Highlight**, **Image** and **All**.

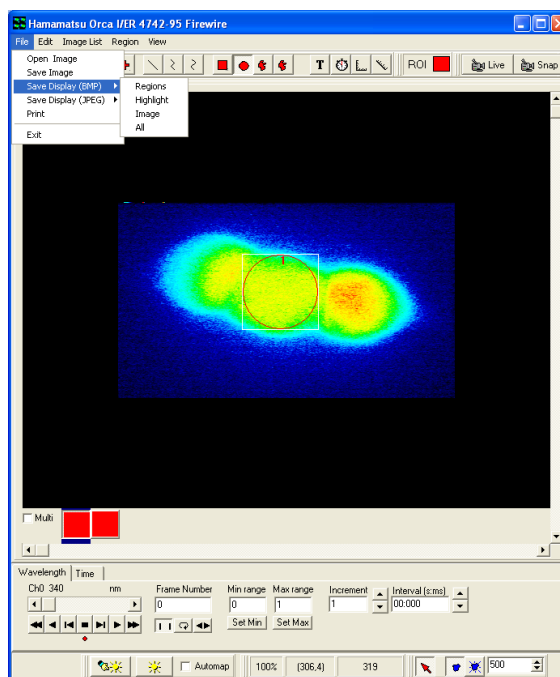
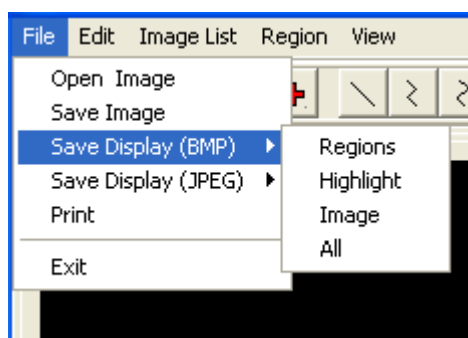

3. To save only the region outlines, choose **Region**. The resulting image in this case would look like this:

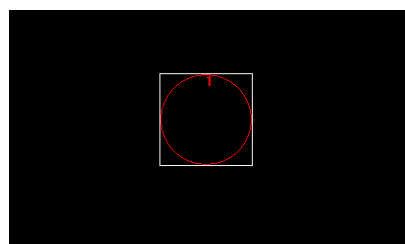

4. To save the highlight produced, for example, by the **Threshold** option in through-series analysis, choose **Highlight**. An example of this is:

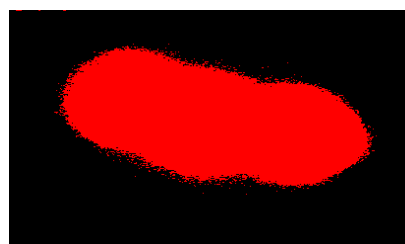

Andor iQ How To Documents

5. To save only the image itself, choose the **Image** option:

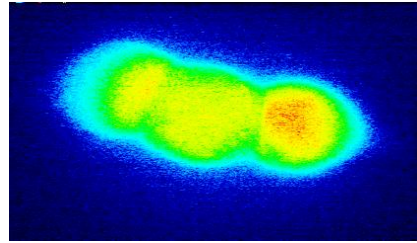

6. To save image plus ROIs and Highlights seen in the Image Window, choose **All**:

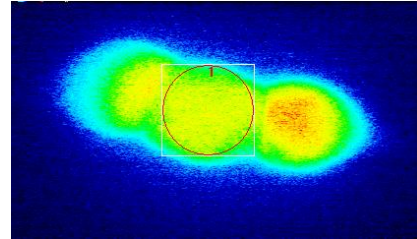

7. Both **JPG** and **BMP** options will show a File Browser window, where the destination drive and folder for the image are selected and a name for the destination image can be entered..

8. If you selected **JPG**, a **JPEG Compression Quality** window will be displayed. The default value is 75, giving a good compromise between image quality and file size. A smaller value will decrease both the image quality and the file size.

A5.14. How to Copy Images to the Clipboard

1. To copy an image to the Windows Clipboard for use in other programs, select **Edit** from the Andor iQ Image Window, then **Copy to Clipboard**.

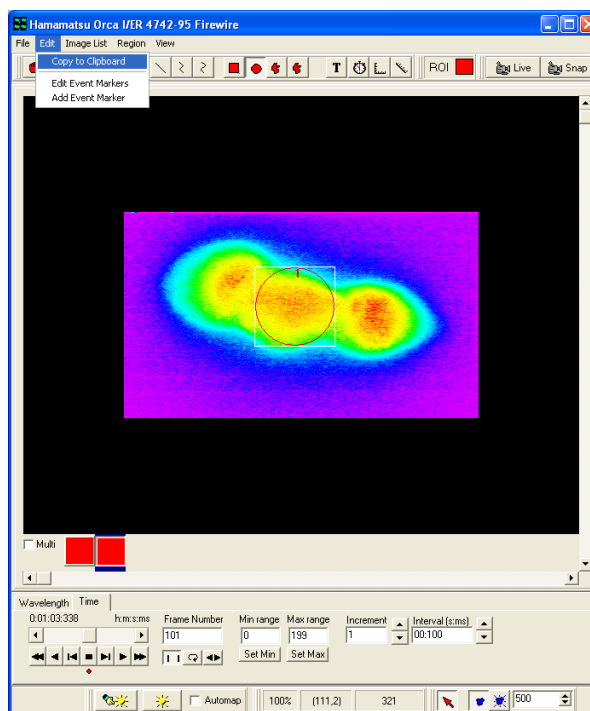
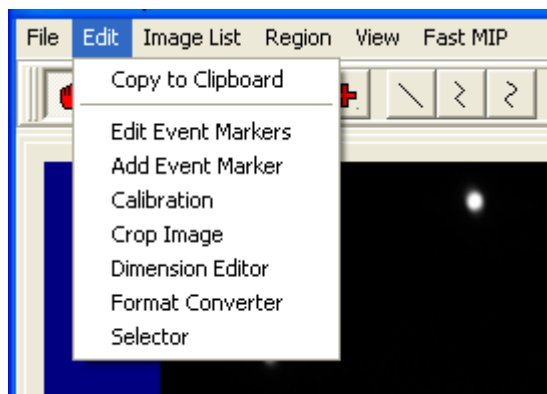

2. This is a standard Windows function, allowing **Pasting** of objects in the clipboard into other programs, for example word processing, presentation or image editing programs.

3. The method of pasting images into other programs will vary, but is typically accessed from the **Edit, Paste** menu. Again, depending on the program being used, there is also a standard Windows shortcut assigned to pasting; **CTRL + V**. Please refer to the program's documentation as to how to copy, paste and cut objects to and from the clipboard.

A5.15. How to Share and Backup Protocols

1. To **share Protocols** (and Channels) between users and systems using Andor iQ, the users and/or systems must have the same hardware configurations established, otherwise the hardware settings will be inconsistent and iQ will reject the Protocol and show an error message.

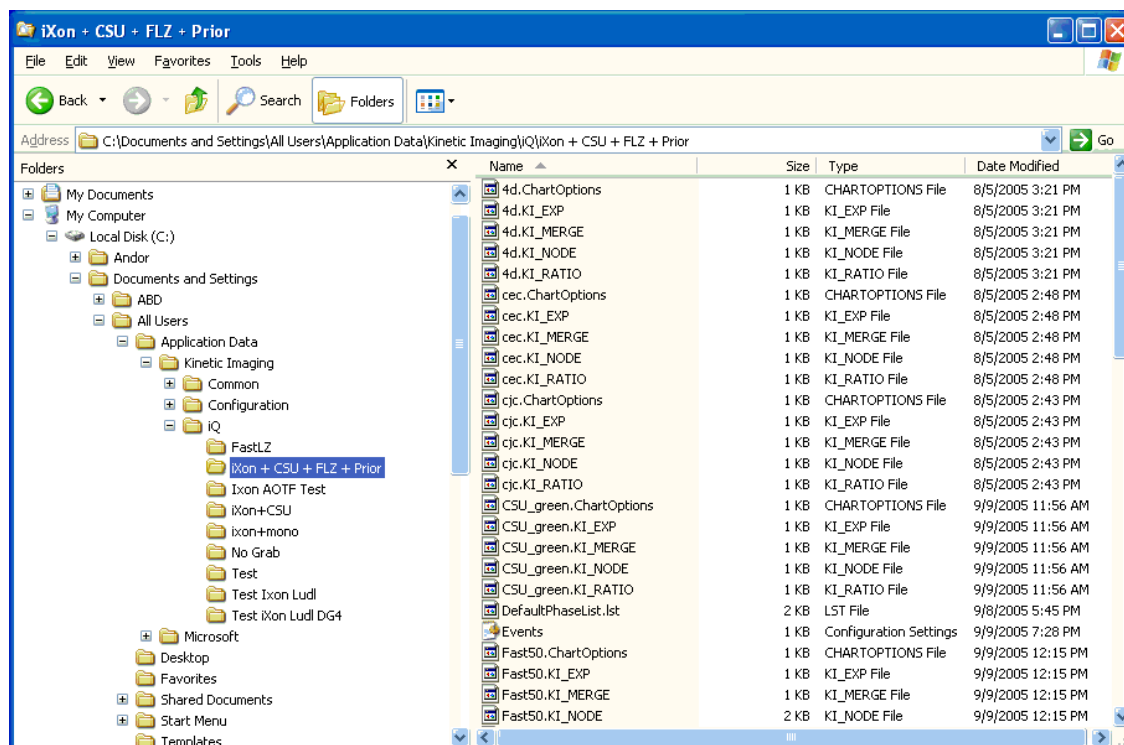

2. Protocols (and Channels) are stored in Hidden Folders, which can be revealed in Explorer under the Menubar "Tools\Folder Options\View" provided you have permission for this action on the PC. The folder, which stores the Protocols is named C:\Documents and Settings\All Users\Application Data\Kinetic Imaging\iQ\Configuration", where "Configuration" is the chosen name of the configuration, as shown in the figure below. This name does not have to be the same between machines or users, but **MUST** have "exactly" the same devices selected.

3. Once you have identified the correct folder(s), you will notice that the folder(s) contain several groups of files with the same name, but different extensions e.g. Fast50.ChartOptions, Fast50.KI_EXP, Fast50.KI_MERGE, Fast50.KI_NODE,

Andor iQ How To Documents

Fast50.KI_RATIO. To share the selected Protocol(s) with another user on a different system, you simply copy all files with the same name and transport them to the other computer e.g. by email. You can create a ZIP file using WinZip and send a ZIP package.

4. Once the files are available on the second system, then locate the equivalent Configuration folder (remember this will be a Hidden Folder) and simply copy all the files into that folder. Note iQ MUST be Closed during this operation. If you sent a Zip file, the Extract operation may find the folder automatically if the Configurations on source and destination machines have the same name.

5. When you next start iQ and select the appropriate Configuration, you will the new Protocols will appear in the Protocol Manager.

6. To **Backup Protocols** (and Channels) simply make a copy of the Configuration folder at our chosen location e.g. C:\Documents and Settings\All Users\Application Data\Kinetic Imaging\iQ\Backup and then, if you get a problem or a user makes undesirable changes you can revert the configuraiton folder to the Default setup form the back up folder.

A5.16. Setting FLZ - Frame Transfer (FT) Blanking

In FLZ mode we use TTL trigger signals from the PCU to keep the hardware tightly synchronized. Therefore the PCU is a key component to this module's functionality. FLZ has 3 acquisition settings and the figure below shows the connections you need to make between the camera, PCU and FRAPPA hardware to support these modes.

Revolution-
New FLZ and FRAPPA/MPU
PCU Connections

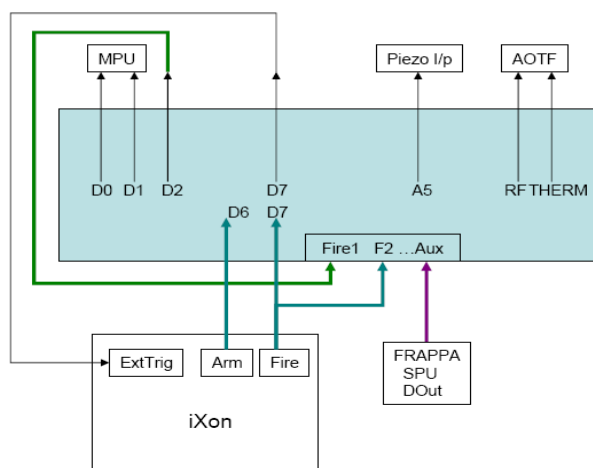

1. Standard FLZ in which the (wavelength and Piezo) devices are set and then the camera is triggered. The simplest mode just requires that DO7 is connected to the Camera Ext Trig input.
2. FLZ Fast Scan, in which additional PCU TTL lines are used to sense the camera status (Fire and Arm) and change the (wavelength and Piezo) devices during camera readout to reduce settling delays. In this case connect Arm to DI6 and Fire to DI7.
3. Frame Transfer mode, where the camera overlaps readout and exposure to maximize performance. In this mode settling times are not used and the camera Fire pulse is truncated to the vertical shift time. Because of this we have programmed PCU output DO2 to be "TTL 1" during the exposure. So **connect DO2 to an Active Blanking input** for proper operation as shown in the figure above.

Note: that we recommend you only run FLZ-FT mode if you have a fast multi-core processor to minimize software latencies which have an impact on exposure time. Exposure time in this mode depends on the interval between trigger pulses, so small variation in software timing can have an impact. Despite this effect FLZ-FT provides the highest frame rate available.

A5.17. How to Configure Triggered Looping with FLZ

In this note we show how to synchronize with an external device via TTL and acquire a series of episodes or events. In this case the user wanted to acquire a series of stimulus-response signals using the iQ system. To get TTL signals in and out of the computer an effective solution is to use the Andor **PCU**. A low budget solution can make use of the Andor **Break out Box** and a **PCI DIO** card, shown below.



The card delivers 24 TTL signals, but we make use of 8 inputs and 8 outputs.

1. To install the card with iQ you can follow instructions in Appendix 3e.

2. Then create a **Configuration** in which the **Kinetic Trigger Device** and **FLZ** camera drivers are loaded.

3. Start iQ, select this Configuration and then in the Device Setup dialog shown above, go to the Trigger device Settings tab and make sure that the Control Board is connected, as shown above. If not selected, use the drop down to select the board.

4. On the Trigger tab you see **Input and Output tabs**, with corresponding input and output TTL signals shown.



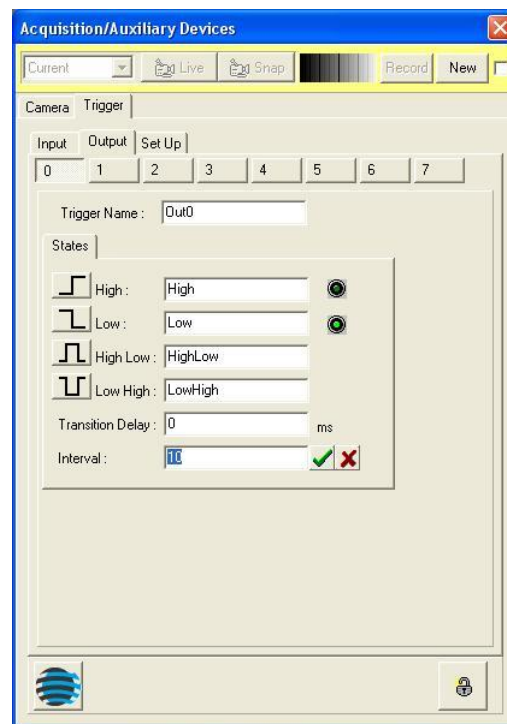
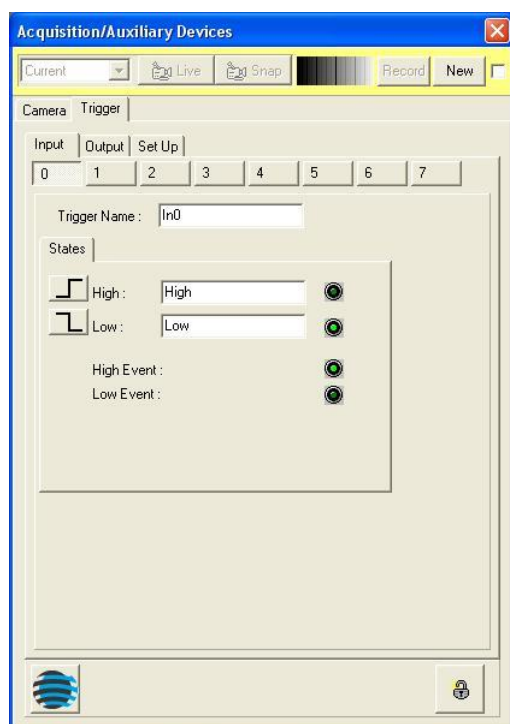

5. Depending on which TTL signals you intend to use, 0 thru 7 for Input and Output, you can monitor or set their status on these tabs. The 8 buttons along the top of each tab switch the user interface to reflect the current state of the relevant inputs and outputs.

Inputs sense **TTL levels** so that input signals must remain in the defined state long enough for iQ to sense while other actions are taking place (this depends on other actions, but a minimum of 100ms is a good starting point).

Outputs are used to send **TTL levels or pulses** as indicated above.

On the Output Tab, **Transition delay** is measure of the response time of an external device if it needs to follow the Output state. **Interval** defines for how long the pulse state will be held.

E.g. 1 if you want to send a pulse of 10 ms duration, select the pulse polarity, set Interval = 10 ms, Transition delay = 0.

E.g. 2 if you want to open an external shutter for 50 ms and it takes 15 ms to open (and close) fully then set Transition Delay = 15 ms and Interval = 50 ms.

6. Now we are ready to create an FLZ Protocol and insert Trigger actions to control the start of a capture Burst, send a TTL pulse after each Burst, send a TTL pulse after each Burst and then wait for the next TTL sequence to start the next Burst cycle. To do this create a New Protocol and select the Fast Option as shown right.

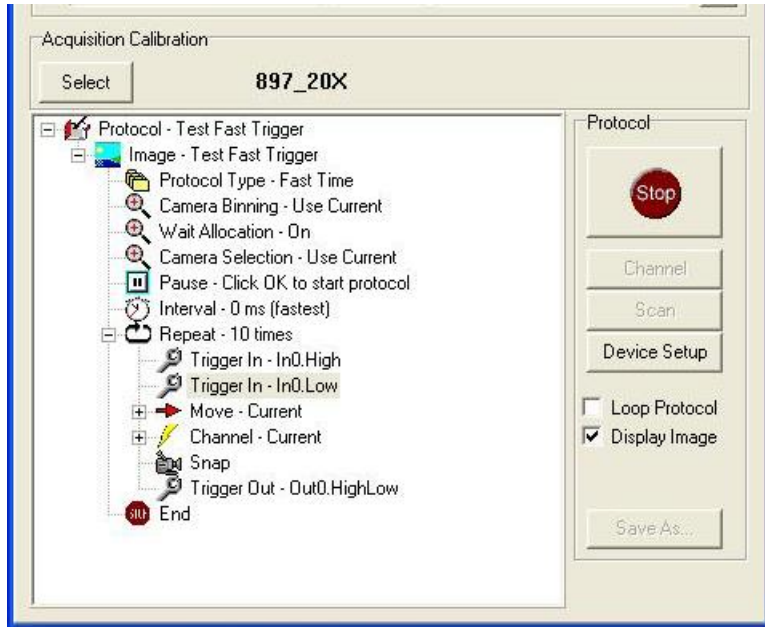

Note: we use the default Channel “Current” here so that we can adjust the camera settings without having to Record them in a separate channel. But if you want to use a specific Channel then you can do so.

7. We can edit the Protocol to Set Repeat = 10 FLZ sequences or Bursts. To Insert the Triggers and the required states simply use the Right mouse Insert at the required point in the Protocol sequence. In the case above we wait for Input 0 to go Hi (TTL=1) and then Lo (TTL=0) again to start the Burst. We use **Move To** make sure the devices are in position before we enter FLZ and when the FLZ Burst is complete we return to the Protocol and iQ sends a pulse (High-Lo) from Trigger Out 0. The pulse width was set to 10 ms above.

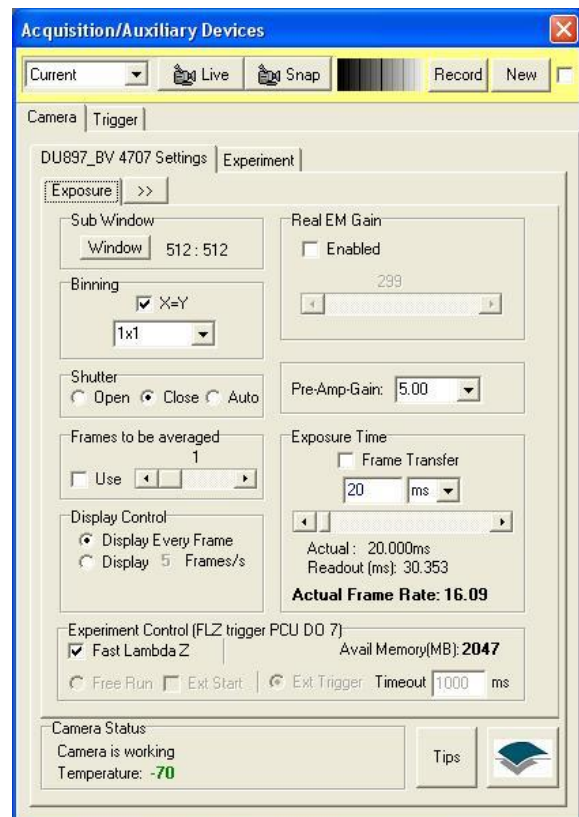

8. In this case the Camera (above) is set to Fast LambdaZ mode. Because we use the Current channel all the settings in the Device Setup dialog are used for imaging.

9. Now let's take a look at the FLZ Experiment tabs to see what happens in the FLZ Burst as shown below. Using the Burst control Edit settings allows us to specify the number of Bursts = 100 and the Burst interval to be zero.

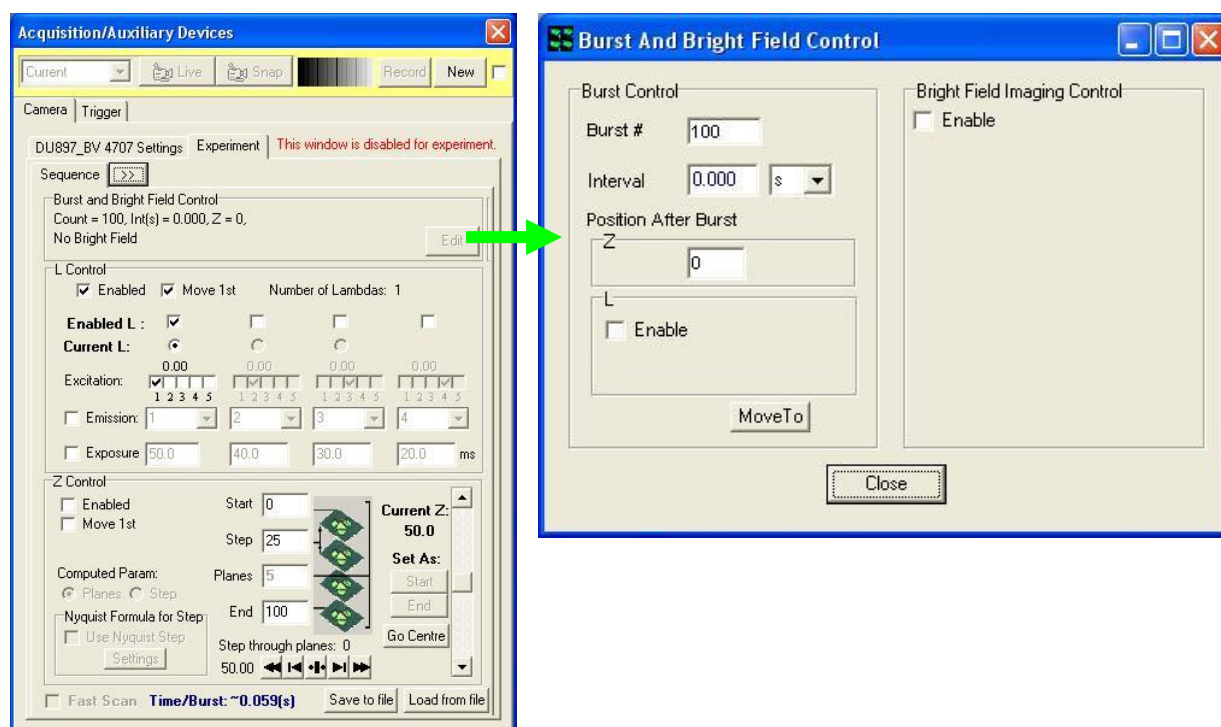

10. Note that the Sequence tab above shows only a single wavelength (L) for capture, so this is a single acquisition with excitation, exposure and emission settings as indicated on the interface. If Exposure is not set on Sequence tab, then it uses the value set in the Current channel – (20 ms on the previous page).

11. Now everything is setup to run a series of 10 Bursts with 100 frames per Burst i.e. 1000 frames will be acquired, but the system will require Trigger Input 0 to show a Lo, followed by a Hi TTL level before each Burst. At the end of each Burst iQ will issue a 10 ms pulse indicating to the external hardware that it should initiate the next Burst when ready.

12. On the last page (over) the iQ Control Window shows the Protocol being executed and at a synchronization step after the first Burst has been captured. The Protocol Status shows iQ is waiting for the **Trigger Input 0 High** signal to start the next synchronized acquisition Burst. It also shows that iQ has captured 100 frames, or one Burst and the elapsed time is 6.172 seconds since the start of the Protocol.

13. Hopefully it will be apparent how to adjust these settings for your own specific requirements.

14. Please contact Andor technical support team if you have further questions or suggestions.

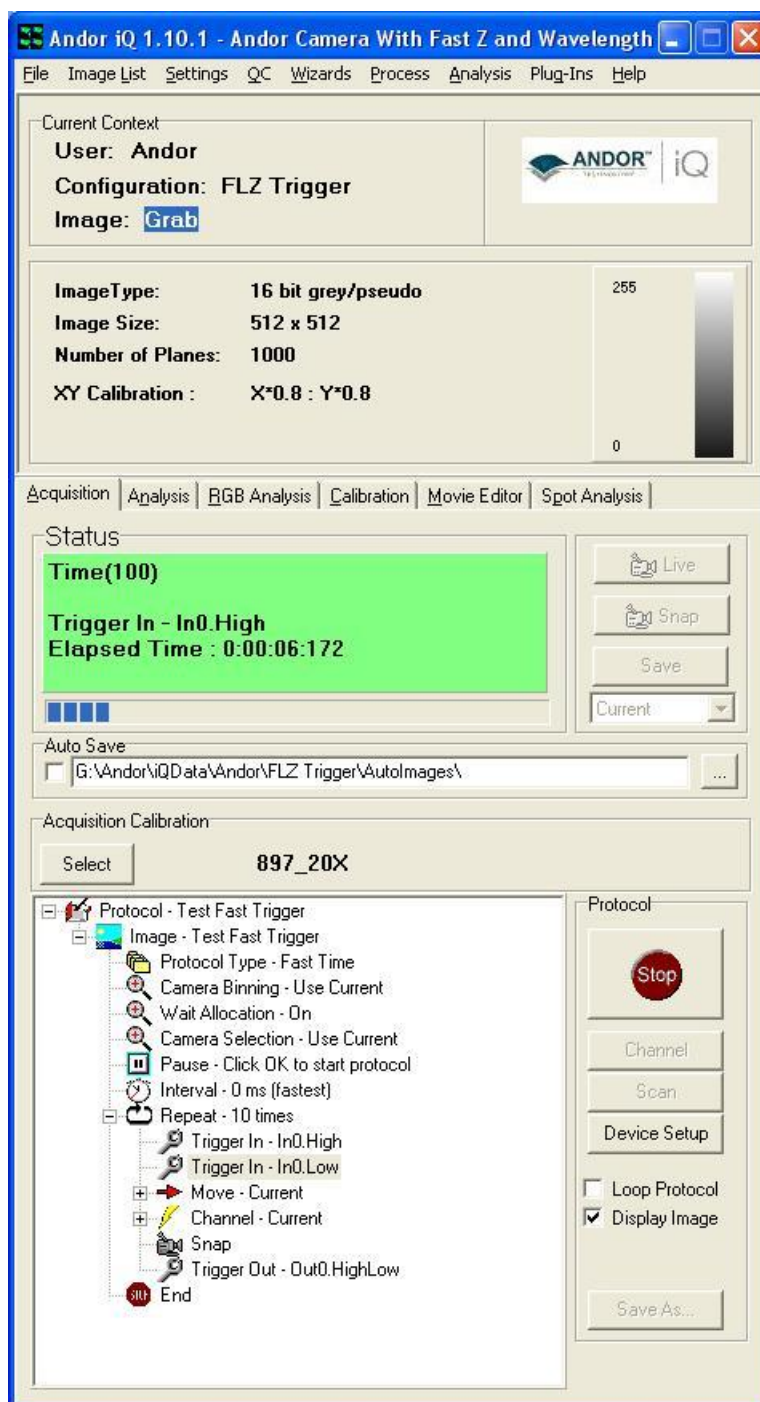

A5.18. How to Troubleshoot DSD Calibration

If DSD fails to run the calibration procedure, there could be several reasons, but a common cause is that the filter turret dichroics are slightly misaligned. This can result in offset in CCD camera images. Try Calibration several times to be sure that a repeatable problem exists. If you need to troubleshoot further, set the DSD processing module of iQ into Debug Mode to get more instrument control. Follow these steps.

1. Close iQ, open the File Manager Go to the folder “drive:\Documents and Settings\All Users\Application Data\Kinetic Imaging\Common”. Drive will normally be C:, the system drive, but may differ in multi-boot systems. In the Common folder you will find two files as shown below.

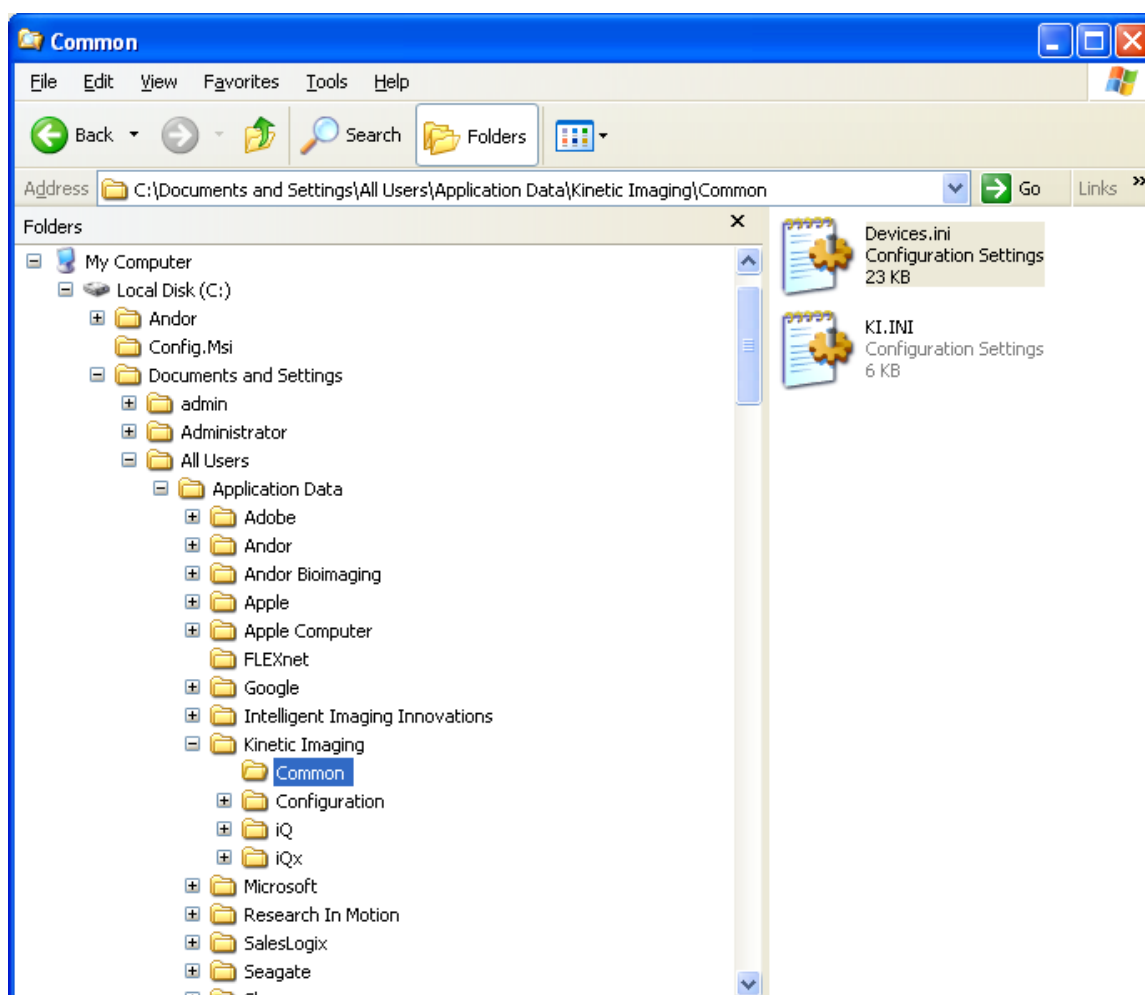

2. Open Devices.ini for editing with Notepad.

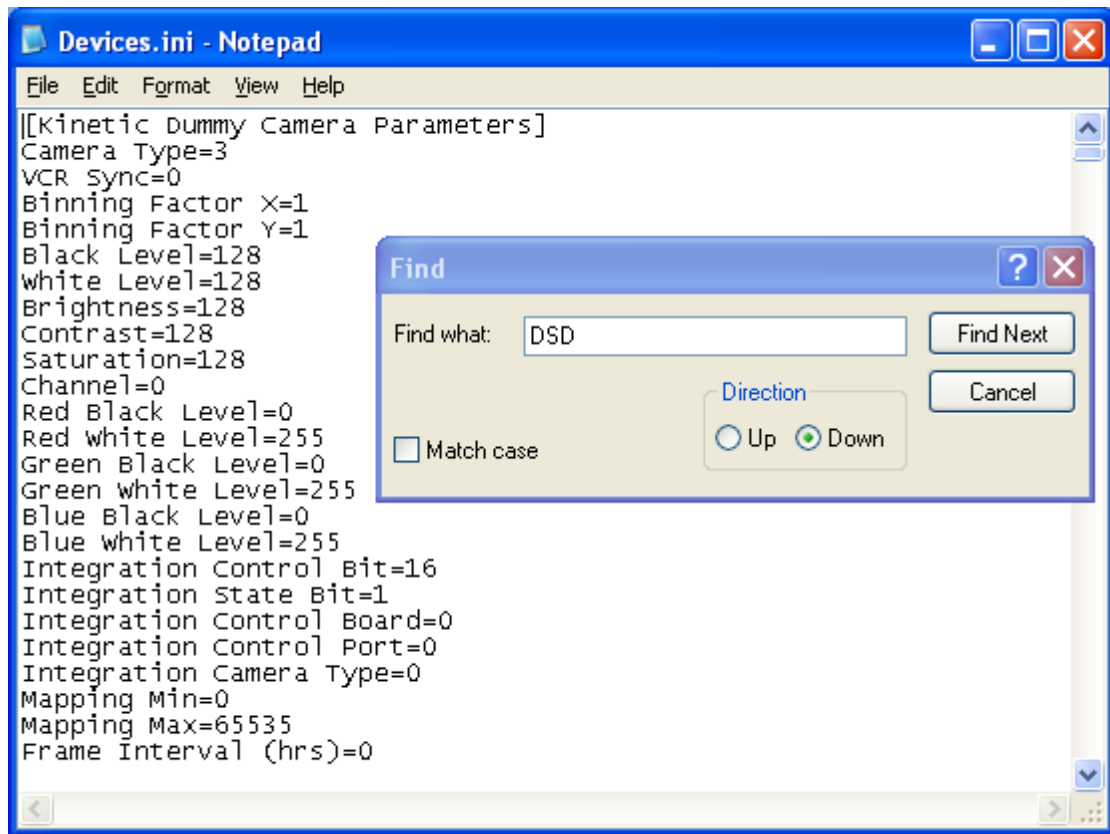

3.

3. Search for the string "DSD" you may find more than one entry, but you need to select the one entry which matches your current iQ Configuration.

4. Change the Debug Options = 0 to Debug Options = 1.

5. Save and Close the file.

6. Open iQ with the same Configuration

7. Show the Device Setup dialog and when you switch to the DSD processing page you will see a series of tabs on the bottom of the dialog. The DSD control tab allows you to "Toggle Penrose" on and off. When you do this you will see the registration pattern and you will be able to gauge or measure whether it is centered by checking the location of its axis of symmetry - see the figure below.

8. The center of the CCD chip is at column 696 of the camera chip. If the axis of symmetry is more than 20 pixels in either direction then you will need to adjust the relative position of the camera and DSD. To do this, feel the tension between the stage and the DSD C-mount clamping screw and adjust and lock them in alternating steps, while maintaining a center of symmetry close to column 696.

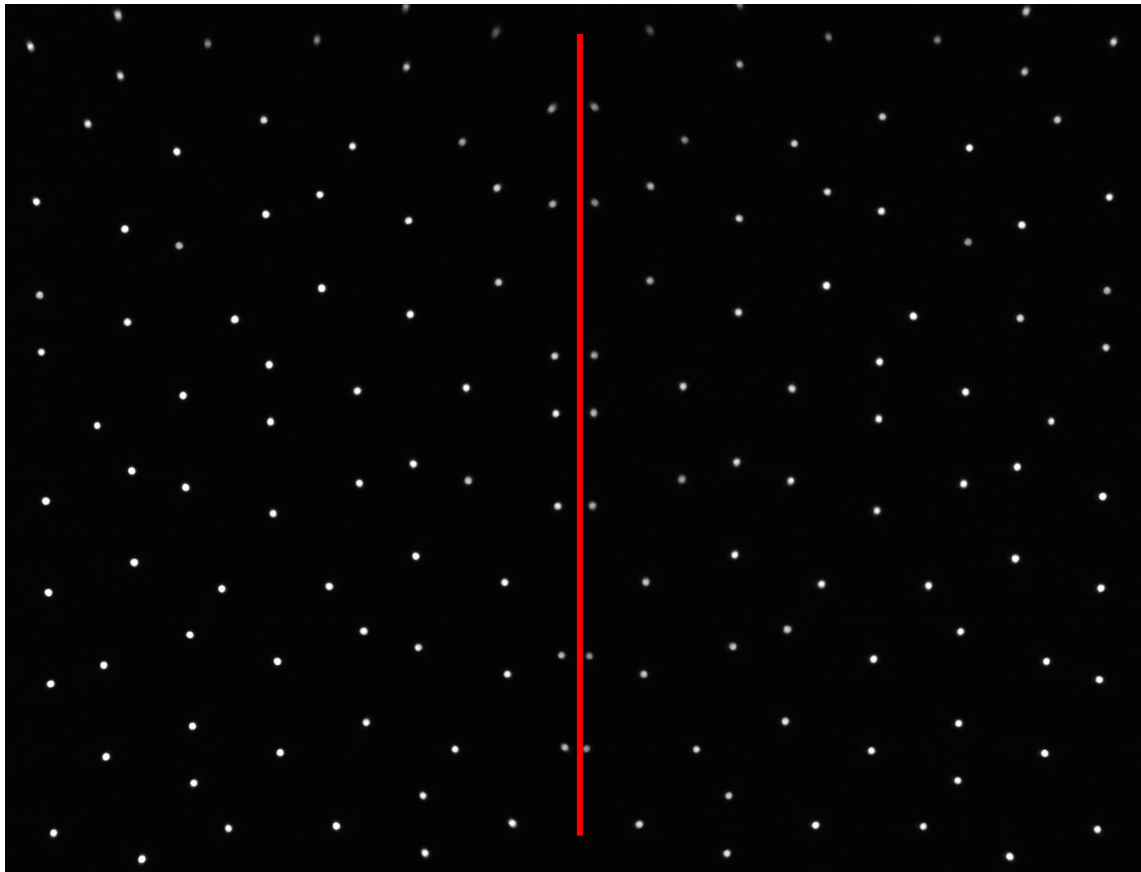

A Penrose mask is used for alignment. To achieve alignment the camera must be shifted left-right relative to the DSD.

9. You can also check the focus of the Mask. This is unlikely to need adjustment, but if you are concerned about it please contact an Andor product support specialist for more information.

10. Once the problem has been resolved you can reset the Debug Options = 0 via the same Devices.ini file.

11. If the system continues to fail in iQ alignment calibration, then you can run the land marking procedure detailed below.

12. **Land marking** is required for consistent and accurate registration of adjacent conjugate calibration patterns created as an intermediate step by the DSD Revolution system.

13. Once the system is mechanically aligned, run an alignment calibration to completion. (Don't worry if the calibration fails, just continue to the next step)

Andor iQ How To Documents

14. Navigate to 'C:\Program Files\Andor Bioimaging\Common Files\DSDProcessing\ImageJ' and double click ImageJ.exe to open the application

15. From the ImageJ Plugins pull down menu choose: Andor | Landmark Calibration as shown below.

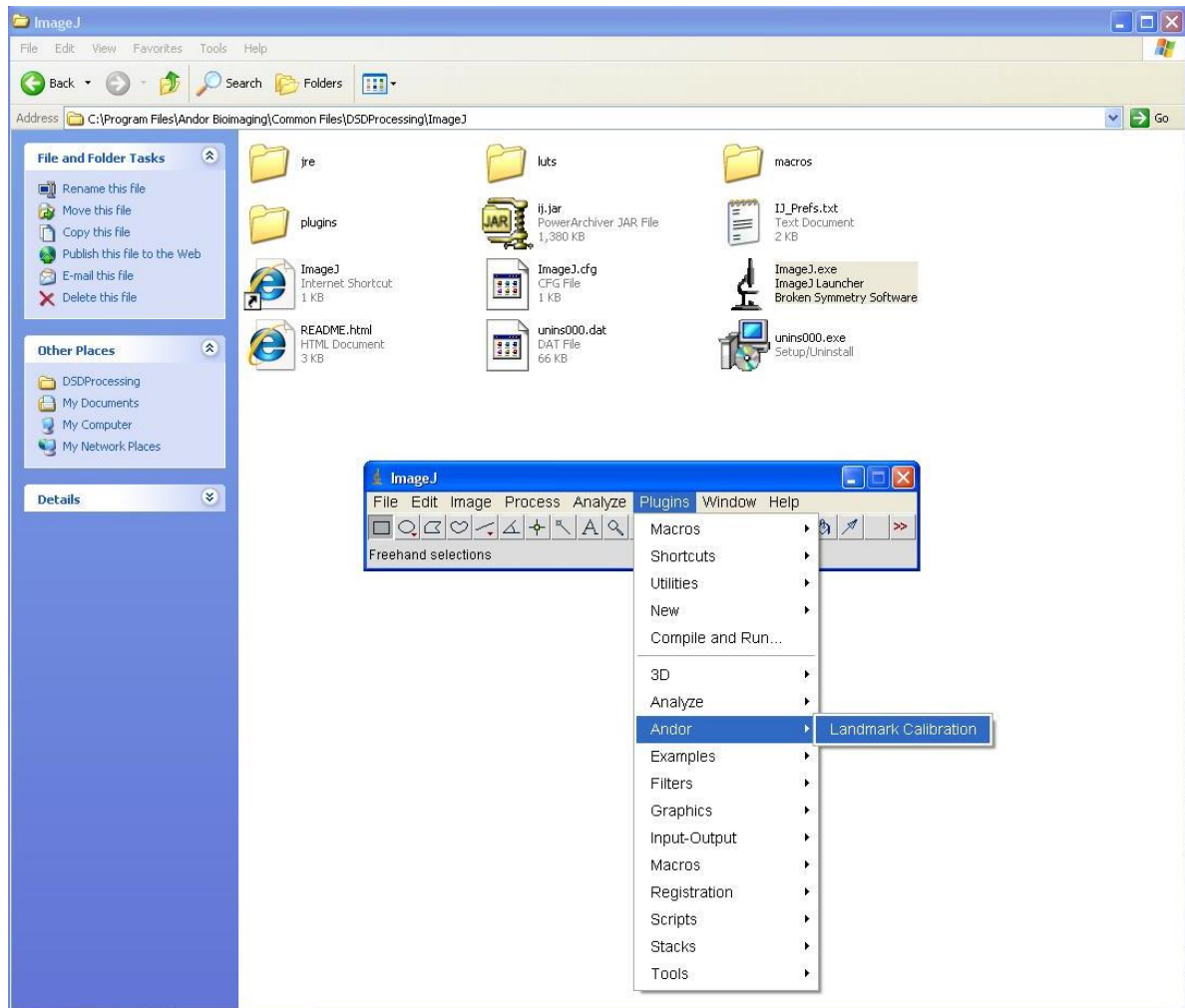

Andor iQ How To Documents

16. The two images opened should show corresponding Penrose dot patterns created at the two locations on the left and right sides of the camera sensor as shown below.

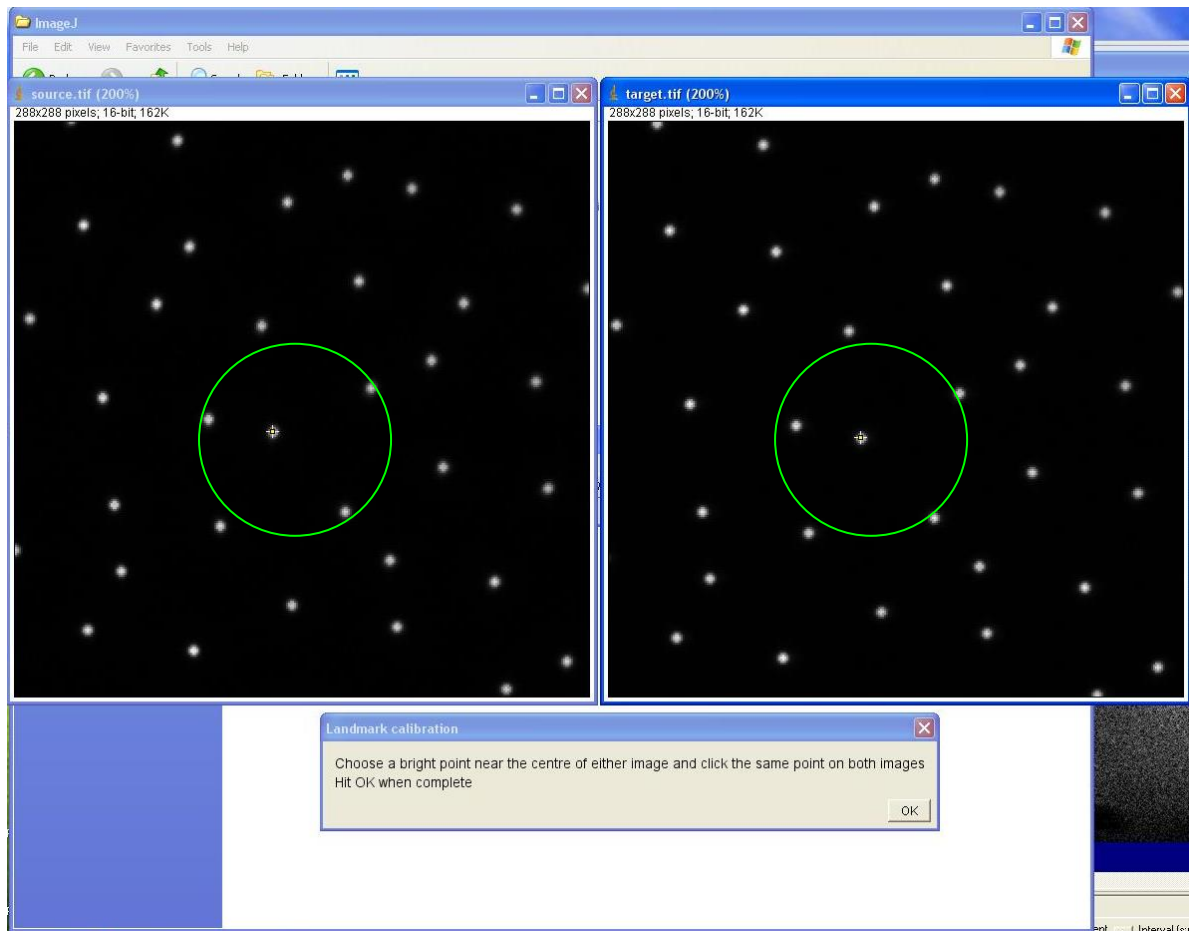

17. Click on a corresponding dot in the two images as requested, as near to the centre of the images as possible, then hit OK.

18. If successful, a Calibration Completed message should be seen.

19. Restart iQ and run again the DSD calibration alignment process and this time you should have success.

20. If either the Land marking or subsequent alignment calibration in iQ does not succeed then you need to contact Andor support for further assistance.

A5.19. How to Setup MicroPoint for Uncaging

MicroPoint is an extremely flexible tool for photo-stimulation, delivering precisely positioned laser pulses over a wide wavelength and energy range. Depending on energy and wavelength setting, the device can be used to perform the following (in order of decreasing energy):

- ablate cells and organelles
- bleach fluorophores
- activate photo-switchable fluorophores
- release caged compounds - breaking molecular bonds

The Micropoint 1 system is driven by a pulsed nitrogen dye laser. This laser has some patented features that allow it to deliver about 25 different wavelengths determined by the contents of a dye cell resonator. The dye cell contains various mixtures of mainly coumarin dyes, which fluoresce strongly and in combination with the resonator provide a tunable pulse delivery system. The nitrogen laser provides driving energy in 70 uJ, 3ns pulses at 337 nm and at 10Hz. These pulses are converted in the various dye cells to wavelengths in the range 365-650 nm with duration of about 4ns. The energy delivered to the specimen can be varied from about 50 uJ down to pJ levels.

When using the system at visible wavelengths, where microscope optics are well-corrected and transmit strongly, the selection of optical components is not too critical, though alignment and focus must be handled with care.

But the system can be used for photo-bleaching at wavelengths suitable for whole cells, organelles, or individual filaments such as actin and microtubules; and at even lower energy levels.

For uncaging, focus is critical because it is typically done at energy levels below bleaching. You must account for the cover slip and any medium in which the specimen exists. The following are the steps to find the best focus setting:

1. Take a slide in which you can identify single microtubules or actin filaments or similar and with a DAPI cube in place and mercury lamp, illuminate the specimen –

the UV cube should be transmitting 365-400 nm –mercury has a 365 and 405 nm line. Get an idea of how long the filaments take to bleach to 50% intensity – a camera helps. This time will give you an idea of how long you may need to pulse the 365 nm MicroPoint for similar effect.

2. Turn the 365 nm energy level down below the damage threshold and try the same thing with the MicroPoint – pulsing continuously for several seconds if needed. Make note of how long this takes – again it will depend on the energy setting, but also on the objective transmission and the focus of the MicroPoint.

3. Spot one of the filaments and trigger the MicroPoint to output 5-10 pulses. You should see some bleaching if not increase the power a little until you do. Now continue this process, changing the focus in between bleaching actions, reducing energy when possible at each step. You should be able to get to the point of bleaching a single filament with a resultant spot in the order of the diffraction limit of the objective.

4. When you go to the cell culture, you may have to correct again by a similar approach to 3 above because you are now in “water” or thereabouts and focus will again be shifted.

Once you have setup MicroPoint for a given objective and specimen you should note the setting for later recall.

A5.20. How to Create a Protocol Template

Protocol templates provide an easy and convenient way for users to create protocols. A template defines a basic skeleton that describes an acquisition patterns. A template does not contain channel or scan information, the user is responsible for adding channels and scan files. It does however provide time repeat loops (both nested and sequential), Z scan loops, place holders for Frappa events and online processing. Andor provides several templates with the iQ installation but the more advanced user may wish to generate their own.

An iQ protocol is defined by several files, Protocol, Channel, Ratio and Camera settings. A template is basically a Protocol file that is located in a special location. By default when a protocol is created, the Channel, Ratio and Camera settings are added using the current state, the user is responsible for modifying these as required.

The steps for adding a template are

1. Create a protocol and give it a name that will represent the acquisition pattern
i.e. MyTemplate

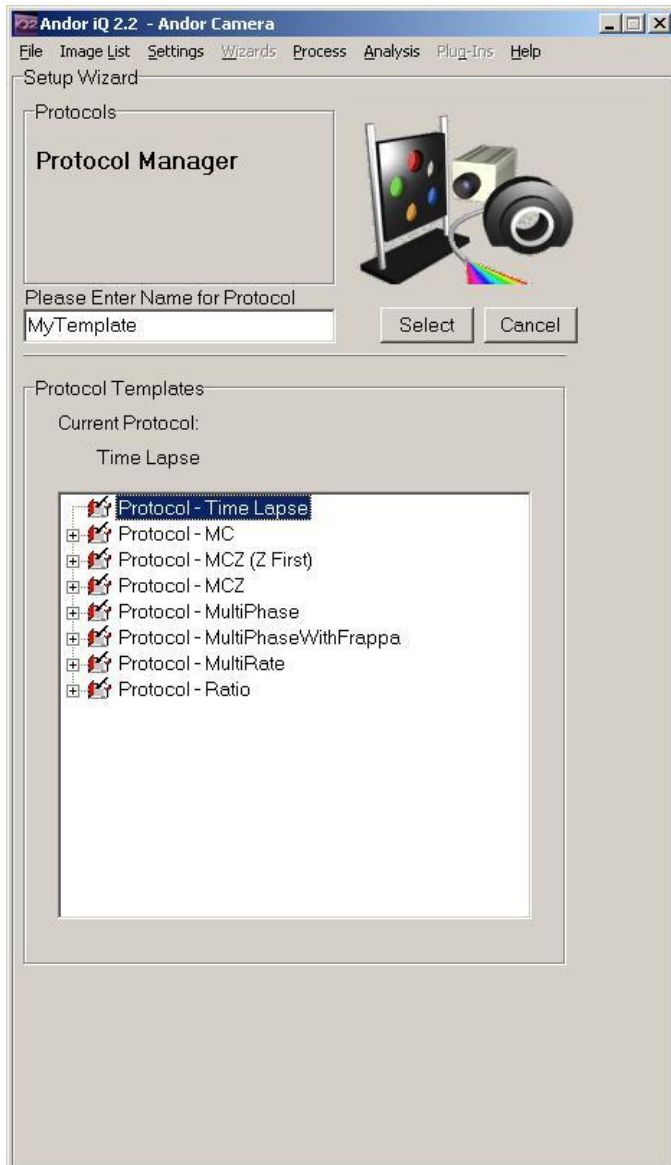

2. Build a protocol with the basic pattern that you require.
i.e. Three sequential time loops with a frappa event in between each repeat loop, one frapping the nuclear regions, the other frapping the cytoplasm regions. This is just an illustration of the tree and does not necessarily constitute a sensible experiment.

Andor iQ How To Documents

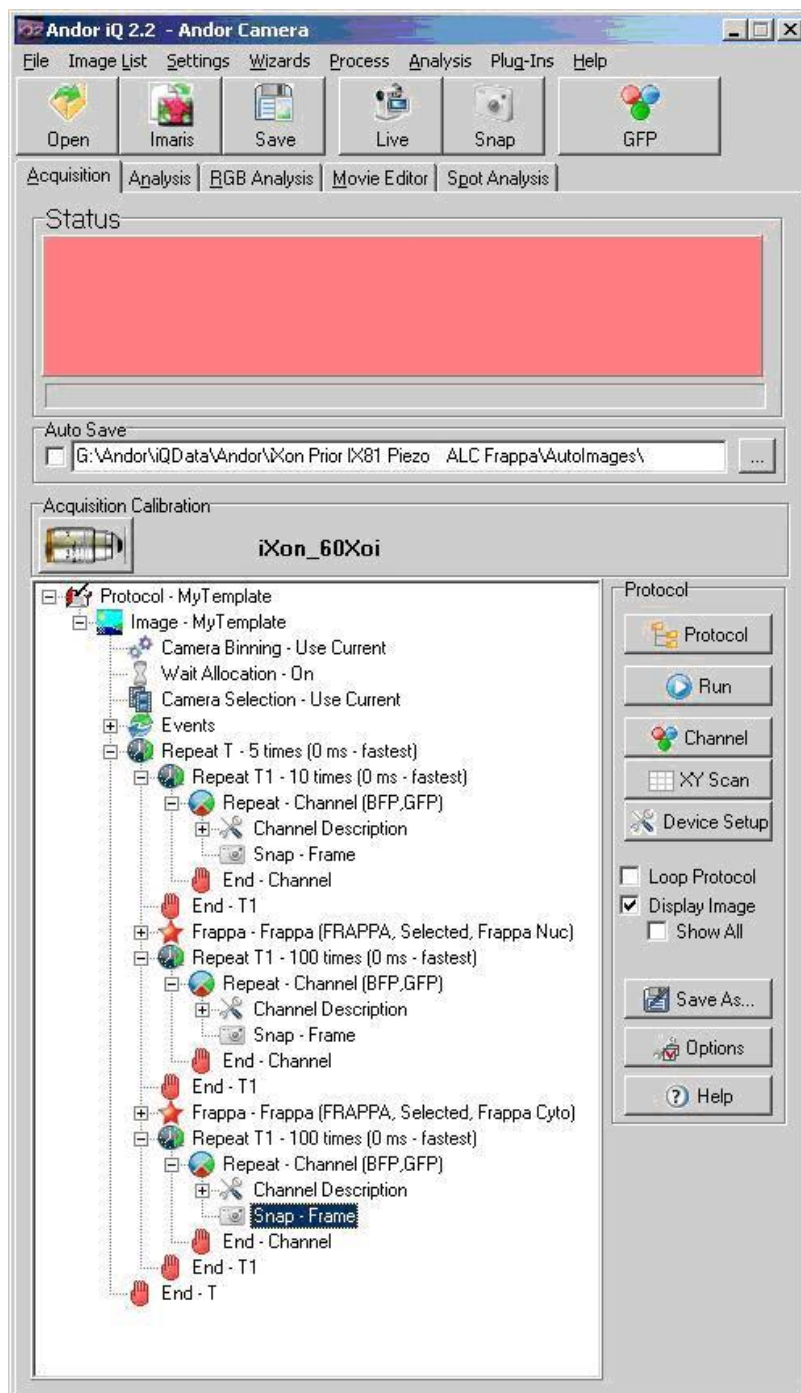

3. Click Protocol and reselect MyTemplate, this will make sure that the protocol files are saved to disk.
4. Using explorer navigate to
C:\Documents and Settings\All Users\Application Data\Kinetic Imaging\iQx, or the equivalent for your installation of Windows.
5. Select the folder with the name of the current configuration
i.e. iXon Prior IX81 Piezo ALC Frappa (see image)

Andor iQ How To Documents

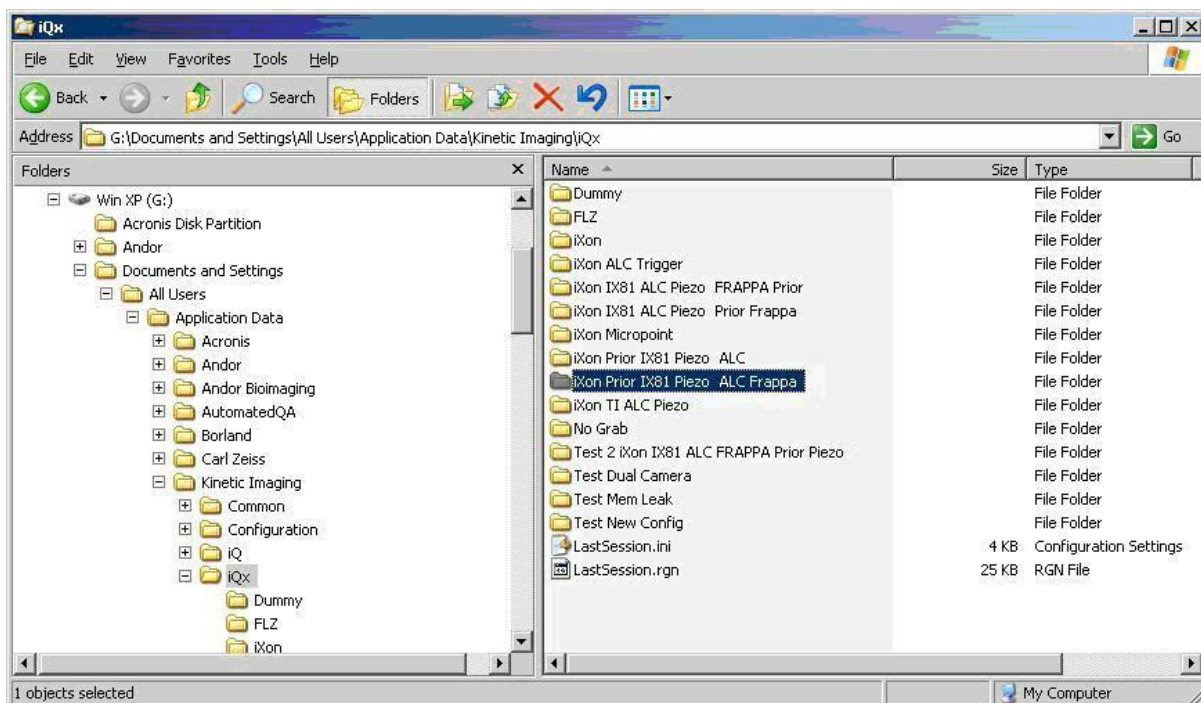

6. Select sort by date, find the latest files and look for the file MyTemplate.KI_EXP and copy to the clipboard. You may need to activate the file extension in windows explorer, see Windows help for details.

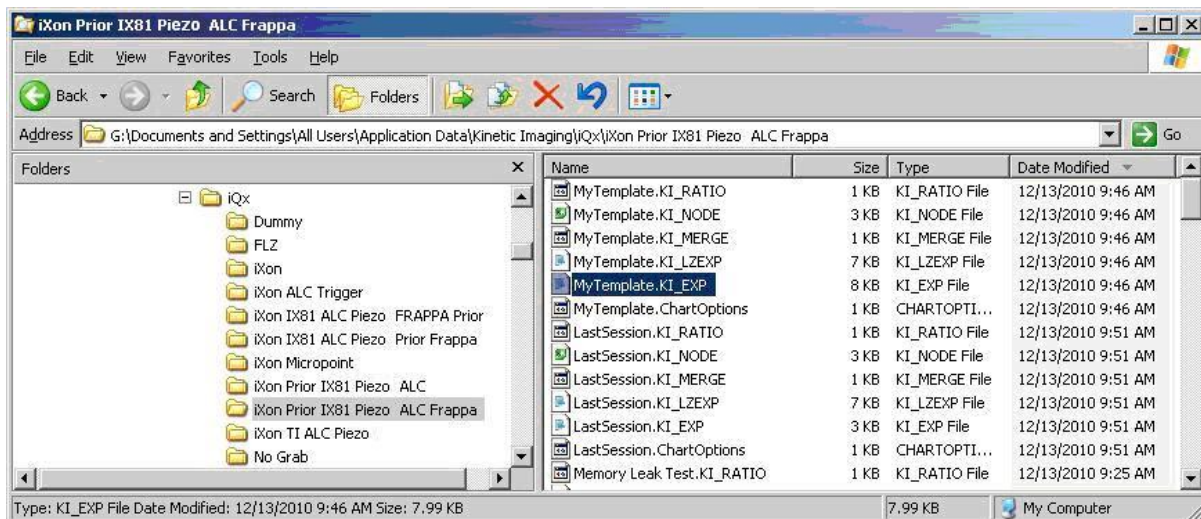

Andor iQ How To Documents

- Using explorer navigate to
C:\Program Files\Andor Bioimaging\Common Files\Templates, or the
equivalent for your installation of iQ
- Paste the file

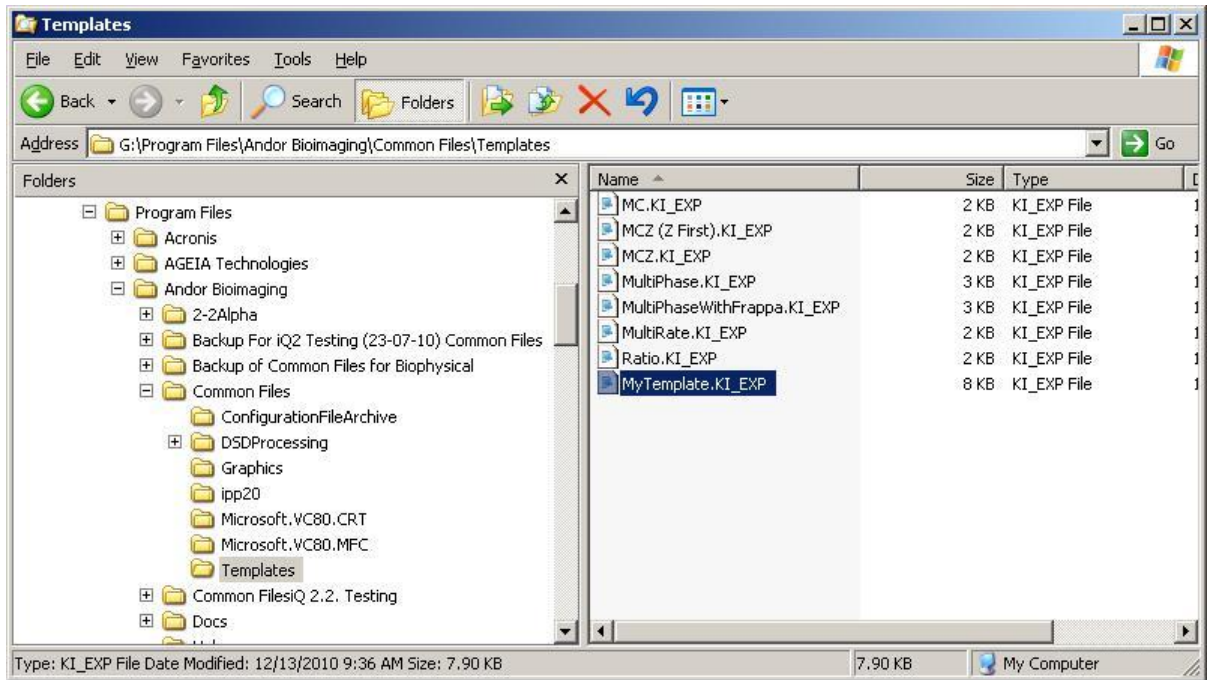

Andor iQ How To Documents

Now when you attempt to create a protocol a new item will be present in the template list.

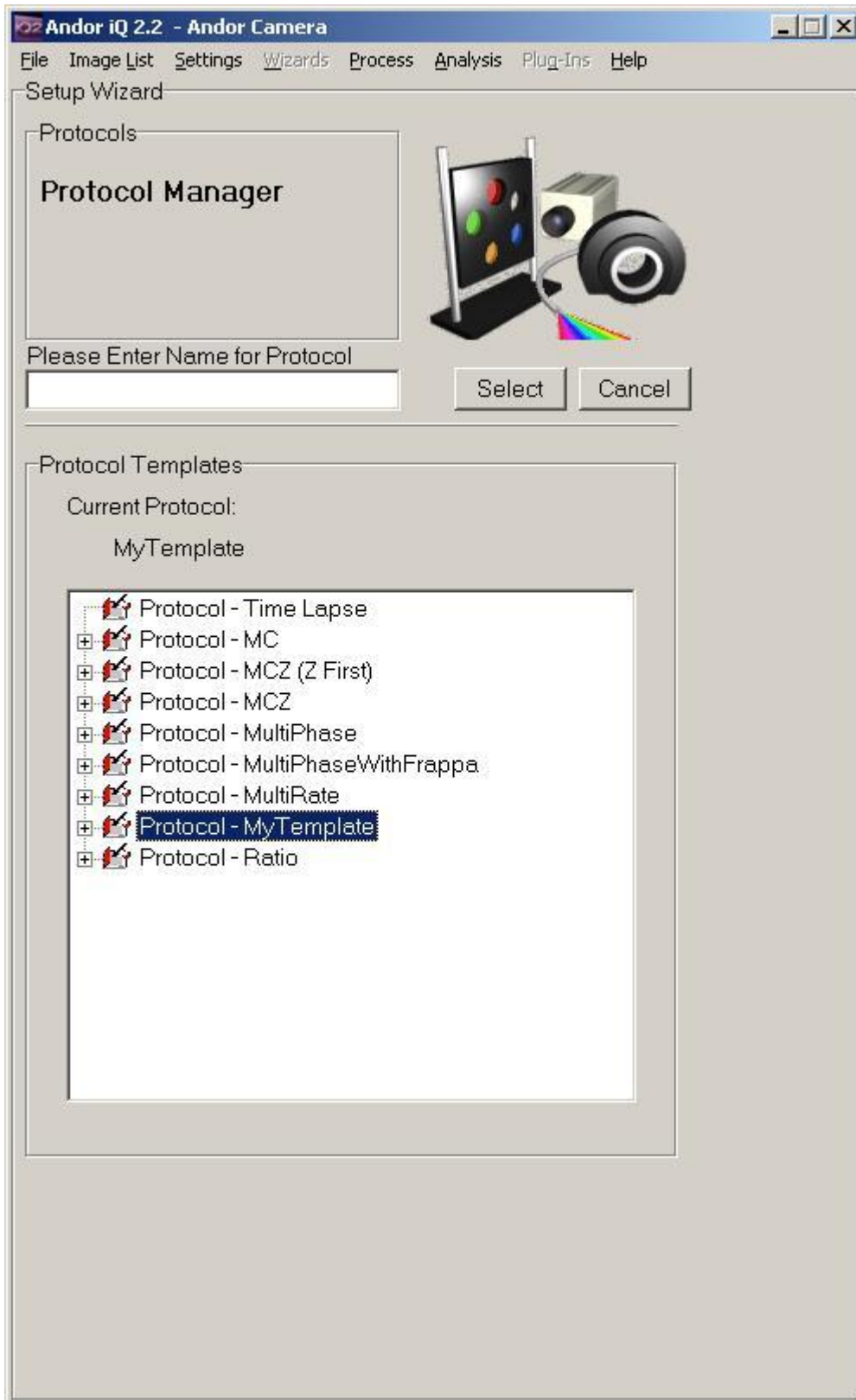

A5.21. Configure iQ with Lumencor Light Engine

The Lumencor Light Engine (LLE) is a high performance solid state multi-line light source, which uses LEDs to pump luminescence in doped crystals. It can be considered as a super-luminous source. The emitted radiation covers up to 7 spectral bands in the near UV-Vis-NIR regions of the electromagnetic spectrum as shown in the figure below. By selection of integrated filters the emission spectra can be tailored to fluorophores used with fixed and live cell specimens.

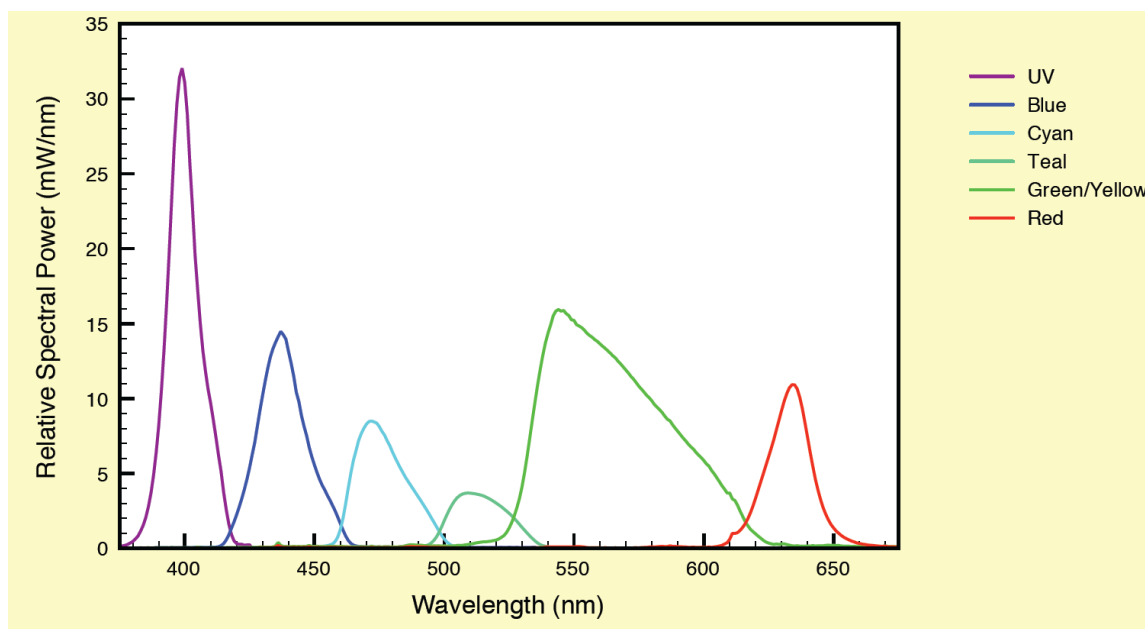

LED light pumps enable high speed modulation (currently 5 kHz) with rise and fall times of $<10 \mu\text{s}$, with typical power stability $<1\%$ of peak. Since LEDs are extinguished whenever a channel is “OFF”, there is no leakage of UV light which can be highly damaging to live cell specimens. LLE has a typical lifetime of 10k hours, ensuring a low cost of ownership. The source geometry leads to highest brightness at the center of the luminescent crystal core and when coupled into a 1mm 0.22 NA silica fiber, LLE delivers up to 5 X power into a given etendue than a conventional arc lamp e.g. metal halide. The combination of these qualities makes the LLE a desirable source for many applications in fluorescence microscopy where specimen longevity and data quality are key factors.

You can control the LLE in iQ with a simple configuration of either the **Generic**

Shutter or the **Trigger and Event** device controller. The sequence that follows shows how to setup the Generic Shutter and how to configure for use with Andor's DSD, but the average user should be able to extrapolate this to his/her specific setup.

1. Build a Configuration (or add to your existing configuration the Generic Shutter device adapter when you work with the LPT interfaces above. If you have a PCU or a BOB device from Andor with free lines for control, then include the Trigger and Event interface in the configuration. The control interface to both adapters is similar, so we use the Generic Shutter as the example here.

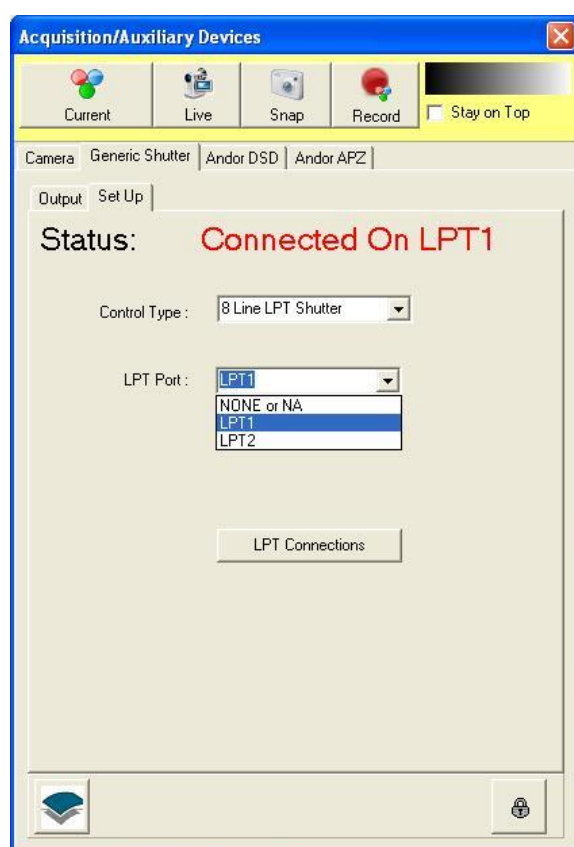

2. Start iQ and you will see the Generic Shutter in the Device Setup dialog. **Unlock** the dialog control (padlock) and Select **8 Line LPT Shutter** and **LPT1 or LPT2**. Note LPT2 is used for PCI or PCIe boards. Then switch to the **Output** tab and setup TTL to LLE wavelengths as shown below.

- When you switch to the output tab you will see the 8 outputs labeled generically. As shown on the right you can edit the Trigger Name and Actions. The LLE logic defaults to TTL Low for ON and TTL High for OFF, so you can rename High, Low and High-Low actions (pulse actions) appropriately. Set the Trigger Name to the LLE channel color and/or wavelength as shown.

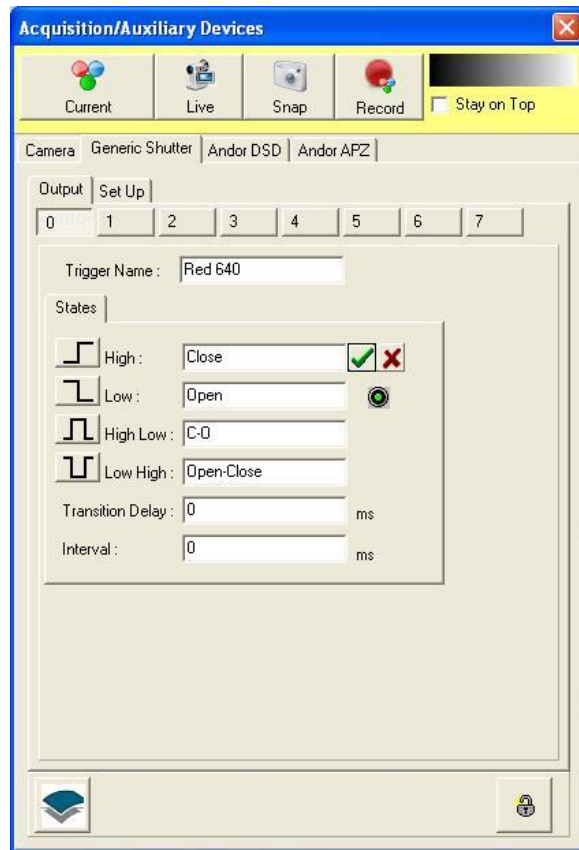

Note: there are two user-defined delay settings. **Transition delay** is the time iQ allows for a shutter to open or close, e.g. wait before acquire frame. In general the LLE is so fast you can set Transition Delay = 0 ms. **Note** that because the Green/Yellow channels use a mechanical switch to select wavelengths that a **Transition Delay = 100 ms** setting should be used for output 7 (see paragraph 6 “Test your device” below). This will ensure proper synchronisation between LLE illumination and camera exposure. Other output Transition Delays can be left at their default values of zero. **Interval** is the duration of a pulse which is used with High-Low or Low High and defines the interval for which the TTL level is asserted High or Low respectively. Pulses can be used for various functions e.g. synchronization.

4. The LLE product can be sourced in various configurations with **3 to 7 wavelengths**. The Table right shows how Wavelengths (colors) map to Generic Shutter digital lines, D0-D6. The mapping is invariant between models i.e. Red is always controlled by D0 in the LPT port and so on. Note that Yellow and Green share a source and D1 must be set in conjunction with D7 to switch Green or Yellow On.

D0	Red
D1	Green/Yellow
D2	Cyan
D3	UV
D4	Teal
D5	Blue
D6	Reserved
D7	G/Y! Low -> Green High -> Yellow

5. Rename the rest of the Shutter outputs as necessary depending on your LLE configuration.

6. **Test your device** - make sure the LLE is in External control mode. Toggle the TTL output by clicking the buttons shown on the left side of the dialog below. Clicking on Low will set D2 (Cyan) to On, while clicking High will set it High and switch it off. Set an Interval to e.g. 1000 ms and when you click on Low-High the Cyan source should pulse on for 1 second.

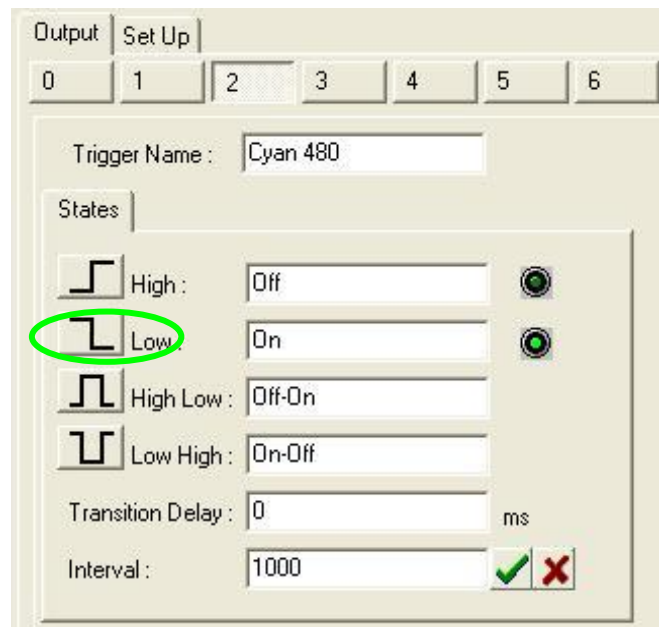

7. If all is working move on, otherwise check hardware connections and state in Device Manager. If there is a problem highlighted with an explanation mark, then check with the hardware manufacturer website for driver updates or known issues.

8. With the control working you now setup Channels for imaging. Setup Channels through the Channel Manager as usual and you will see the Generic Shutter tab as the first in sequence. It will start with all the settings showing Current. Select the appropriate line by left click on the Shutter number and then right click and options will appear in a pop-up menu as follows.



9. In the Pre Frame Action select the Shutter action required immediately before a frame is triggered. In this case the (Green/Yellow) Gr/Yel source will be switched ON. Then in the Post Frame Action select the Gr/Yel.Off action, which will switch OFF the source immediately the frame has finished exposing. Since the LLE uses negative logic and GS TTL control uses positive logic and defaults its outputs Low, you will need to make sure that the other TTL outputs are set to OFF (as shown) to ensure that only the Gr/Yel Source is ON during the frame acquisition.

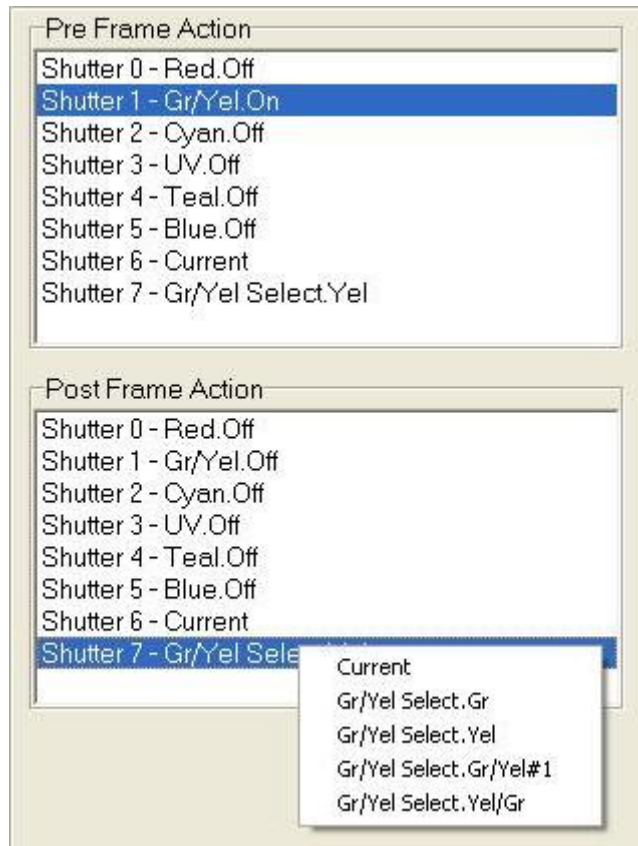

10. Note that the Green and Yellow LLE channels require control of 2 lines. The screen shot of the Channel Manager above illustrates how to select the Green/Yellow source on and off with D7 labeled as Yellow for ease of interpretation.

11. Proceed with creating the Channel in normal way selecting the correct settings for the DSD and then on to camera exposure, gain, LUT etc. Note that in TTL mode the LLE will deliver full power by default, so your primary control of specimen exposure is exposure time, which can be set with high precision in the camera.

12. Once you have setup the desired Channels you can proceed to build the Protocols you wish. An example right shows a time-lapse Z-series with 3 Channels. This appears identical to a Protocol in any other iQ configuration.

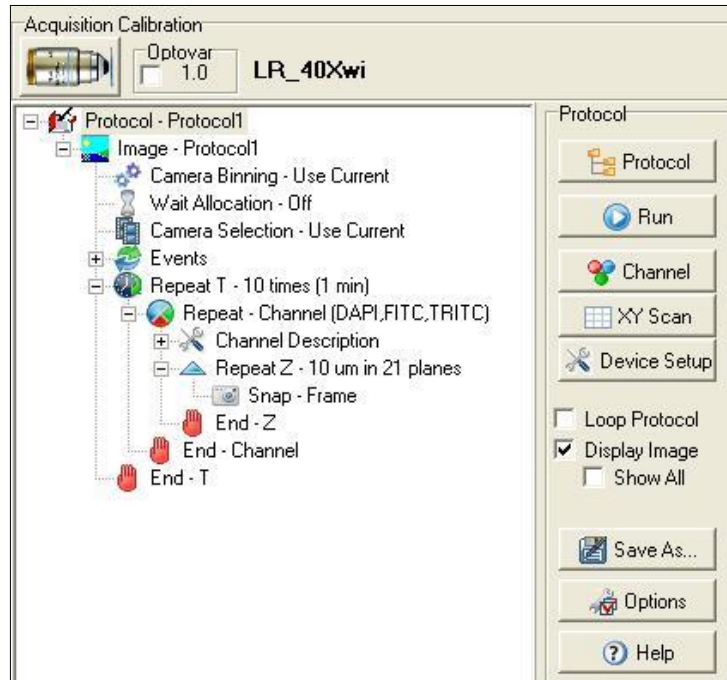

A5.22. Configure iQ with Lumen Dynamics X-CITE XLED1

The Lumen Dynamics XLED is a high performance solid state multi-line light source, which uses LEDs to pump luminescence in doped crystals. It can be considered as a super-luminous source. The emitted radiation covers up to 11 spectral bands in the near UV-Vis-NIR regions of the electromagnetic spectrum as shown in the figure below. By selection of integrated filters the emission spectra can be tailored to fluorophores used with fixed and live cell specimens.

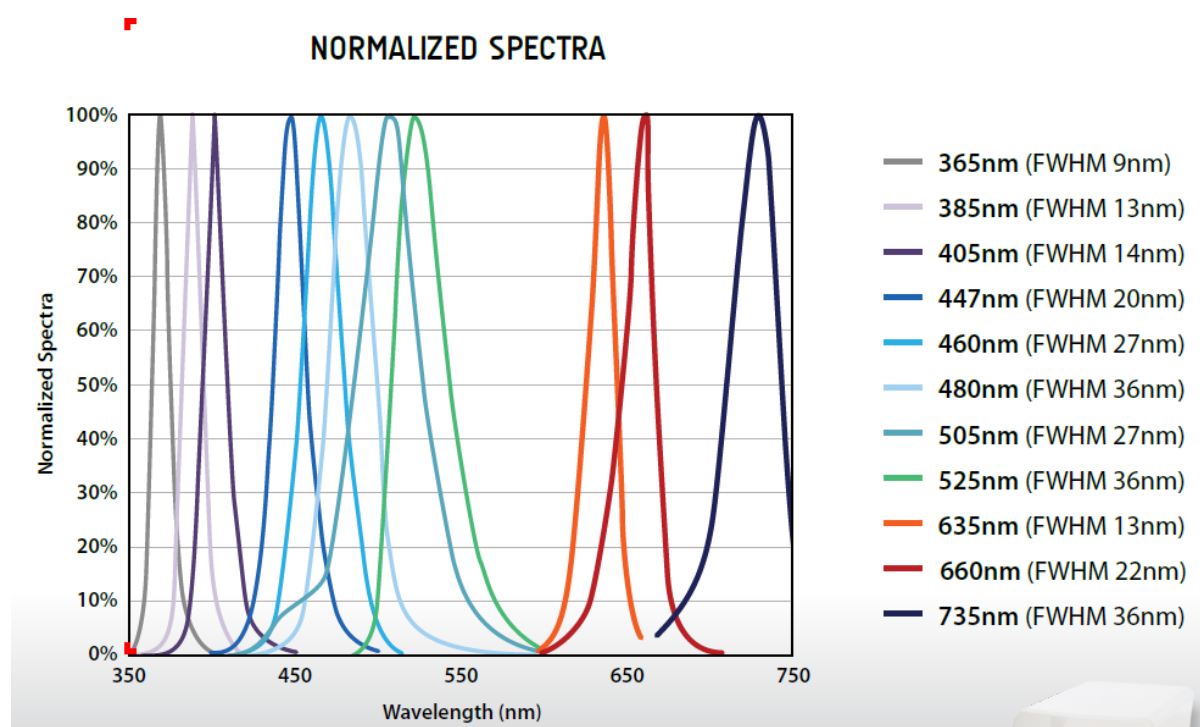

LED light pumps enable high speed modulation (currently 5 kHz) with rise and fall times of $<10 \mu\text{s}$, with typical power stability $<1\%$ of peak. Since LEDs are extinguished whenever a channel is “OFF”, there is no leakage of UV light which can be highly damaging to live cell specimens. LLE has a typical lifetime of 10k hours, ensuring a low cost of ownership. The source geometry leads to highest brightness at the center of the luminescent crystal core and when coupled into a 1mm 0.22 NA silica fiber, XLED delivers up to 5 X power into a given etendue than a conventional arc lamp e.g. metal halide. The combination of these qualities makes the XLED a desirable source for many applications in fluorescence microscopy where specimen longevity and data quality are key factors.

You can control the XLED in iQ with a simple configuration of either the **Generic Shutter** or the **Trigger and Event** device controller. The sequence that follows shows how to setup the Generic Shutter and how to configure for use with Andor's DSD, but the average user should be able to extrapolate this to his/her specific setup.

1. Build a Configuration (or add to your existing configuration the Generic Shutter device adapter when you work with the LPT interfaces above. If you have a PCU or a BOB device from Andor with free lines for control, then include the Trigger and Event interface in the configuration. The control interface to both adapters is similar, so we use the Generic Shutter as the example here.

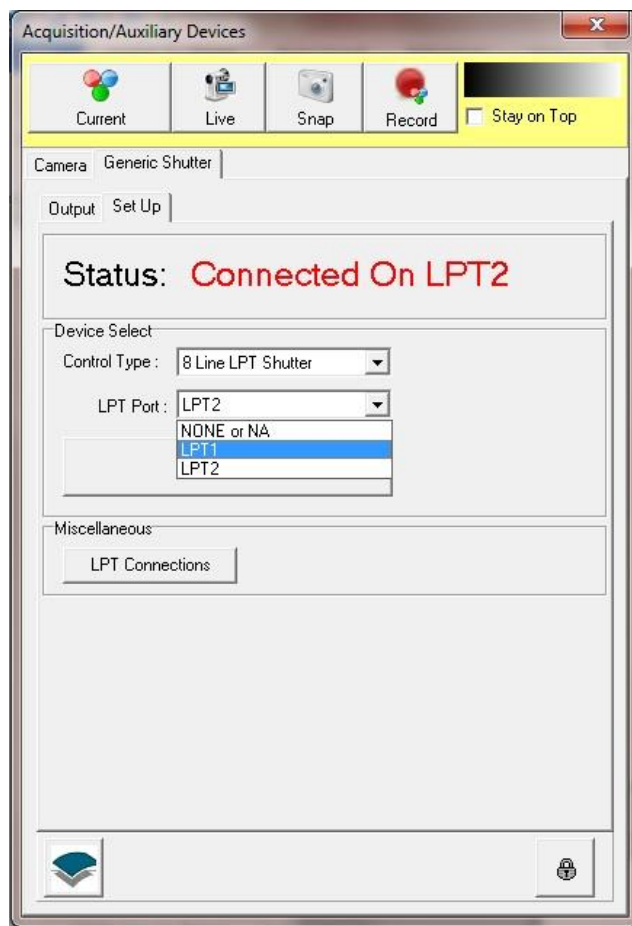

2. Start iQ and you will see the Generic Shutter in the Device Setup dialog. **Unlock** the dialog control (padlock) and Select **8 Line LPT Shutter** and **LPT1 or LPT2**. Note LPT2 is used for PCI or PCIe boards. Then switch to the **Output** tab and setup TTL to XLED wavelengths as shown below.

- When you switch to the output tab you will see the 8 outputs labeled generically. As shown on the right you can edit the Trigger Name and Actions. The XLED logic defaults to TTL high for ON and TTL Low for OFF, so you can rename High, Low and High-Low actions (pulse actions) appropriately. Set the Trigger Name to the XLED channel color and/or wavelength as shown.

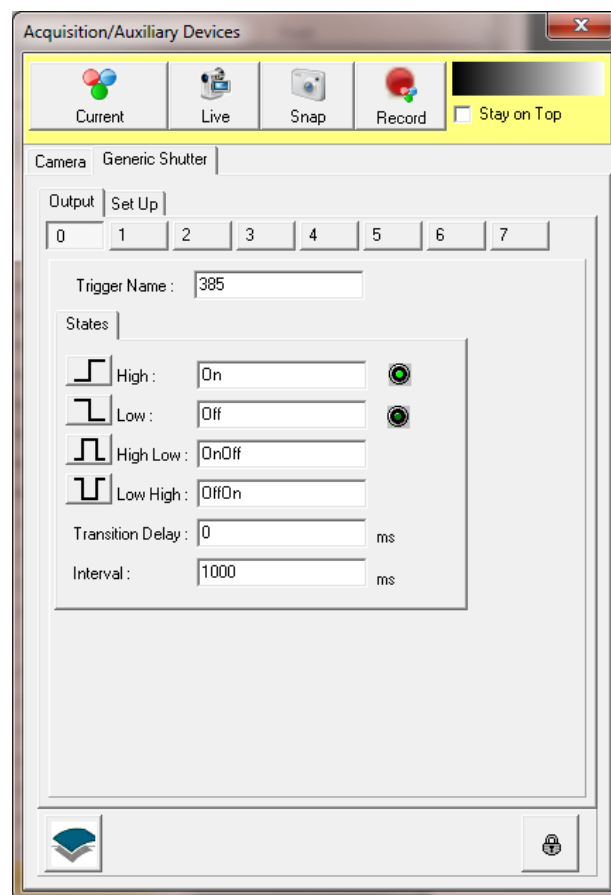

Note: there are two user-defined delay settings. **Transition delay** is the time iQ allows for a shutter to open or close, e.g. wait before acquire frame. In general the LLE is so fast you can set Transition Delay = 0 ms, if required you may adjust this setting to ensure proper synchronisation between LLE illumination and camera exposure. **Interval** is the duration of a pulse which is used with High-Low or Low High and defines the interval for which the TTL level is asserted High or Low respectively. Pulses can be used for various functions e.g. synchronization.

4. The XLED product can be sourced in various configurations with up to **4 wavelengths**. The Table right shows how the BNC Connector (colors) of the XLED maps to the Generic Shutter digital lines, D0-D3. The mapping

Shutter Line	XLED BNC connector	XLED line
D0	Red	1 st LED
D1	Green	2 nd LED
D2	Blue	3 rd LED
D3	White	4 th LED
D4	N/C	N/C
D5	N/C	N/C
D6	N/C	N/C
D7	N/C	N/C

is invariant between models i.e. Red is always controlled by D0 in the LPT port and so on. Note that actual wavelengths will depend on the actual LEDs installed in the unit. For the unit illustrated below this is 385nm, 460nm, 565nm and 635nm. Red cable will control the 1st LED (385nm), White will control the 4th (635).



5. Rename the rest of the Shutter outputs as necessary depending on your XLED configuration.
6. Start the XLED software. This is used to ensure that the unit is in TTL mode and will accept the TTL signals generated by iQ. Select the Trigger Panel to configure the trigger state for each LED, ensure each is set to Ext.



Click Start to enter External trigger mode



Return to main LED Screen

Andor iQ How To Documents



The main LED panel allows you to control the intensity of the individual LEDs. The software must be kept open while iQ is being used for XLED control.

7. **Test your device** - make sure the XLED is in External control mode. Toggle the TTL output by clicking the buttons shown on the left side of the dialog below. Clicking on High will set D2 (3rd LED 565nm) to On, while clicking Low will switch it Off. Set an Interval to e.g. 1000 ms and when you click on High-Low the 3rd LED (565) source should pulse on for 1 second.

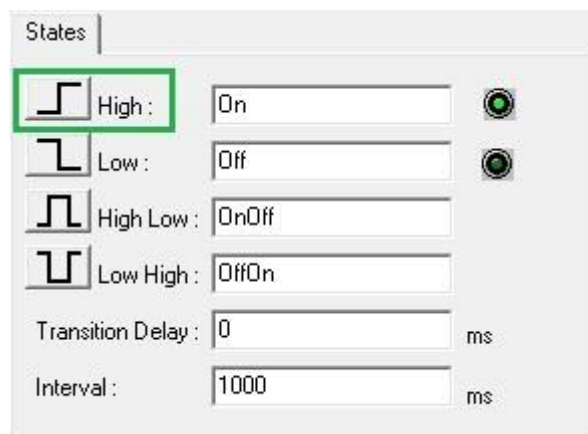

8. If all is working move on, otherwise check hardware connections and state in Device Manager. If there is a problem highlighted with an explanation mark, then check with the hardware manufacturer website for driver updates or known issues.

9. With the control working you now setup Channels for imaging. Setup Channels through the Channel Manager as usual and you will see the Generic Shutter tab as the first in sequence. It will start with all the settings showing Current. Select the appropriate line by left click on the Shutter number and then right click and options will appear in a pop-up menu as follows.



10. In the Pre Frame Action select the Shutter action required immediately before a frame is triggered. In this case 460.On, here the 460 LED will be switched ON. Then in the Post Frame Action select the 460.Off action, which will switch OFF the source immediately the frame has finished exposing. You will need to make sure that the other TTL outputs are set to OFF (as shown) to ensure that only the 460nm Source is ON during the frame acquisition. It is possible to have multiple lines illuminating at the same time.

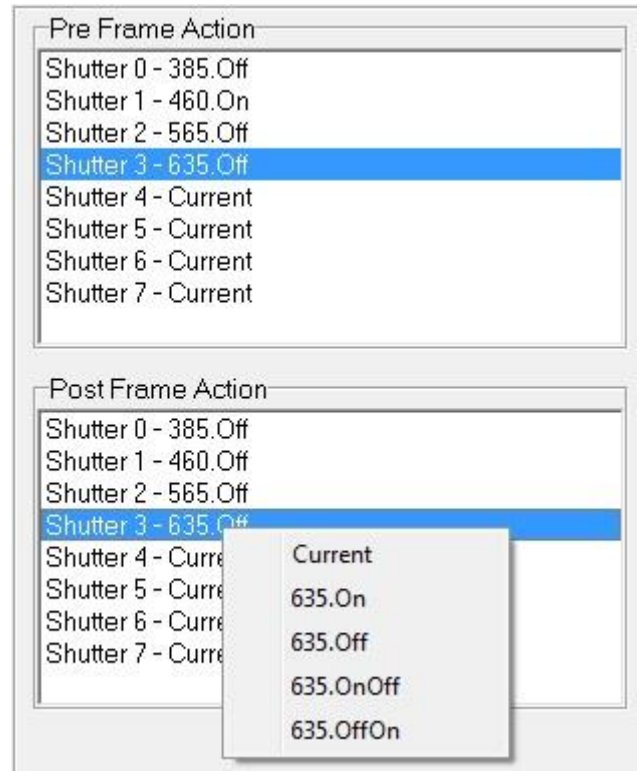

11. Proceed with creating the Channel in normal way, selecting the correct settings for the DSD and then on to camera exposure, gain, LUT etc. Note that in TTL mode the XLED will deliver power defined by the XLED software, so your primary control of specimen exposure is exposure time, which can be set with high precision in the camera. You can use the XLED software to limit the power delivered by the individual LEDs.

12. Once you have setup the desired Channels you can proceed to build the Protocols you wish. An example right shows a time-lapse Z-series with 3 Channels. This appears identical to a Protocol in any other iQ configuration.

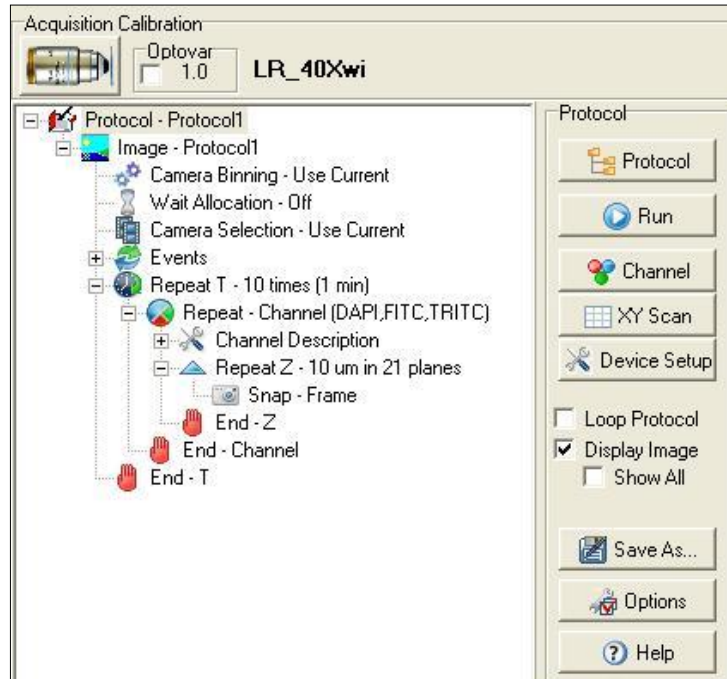

A5.23. Image Registration and creating calibration files for single channel images in the Field Split plug-in

The Field Split plug-in provides users with an Image Registration algorithm to align images from two to four different channels. Image Registration results in a more accurate alignment compared to a simple manual alignment. The alignment is performed using a calibration file which should be created for a specific device and image setting. Any changes in your device settings that results in a change in the output image, such as image size or quality, require a new calibration file to be created.

Required specifications for Images used for creating calibration file for Image registration -

The Image Registration works with 12 bit and 16 bit grey images only.

In order to use Image Registration algorithm and create a calibration file you should load a high contrast image in the Main Image Window.

If you own a Yokogawa CSU-W1, we recommend you to run the calibration on an image of the confocal spinning disk with the biggest pinholes. In order to acquire such an image, first stop the spinning disk. Once the disk has fully stopped, select the disk with the biggest pinholes, if your unit has different disks. See section A3.18 if you need more information on how to use the CSU-W1.

If you plan on using only one camera with the CSU-W1 you will need to be using a CSU-W1 model with a Split View camera port. Before acquiring your calibration image, please make sure that the CSU-W1 is set the same way as it will be during your experiment. Set your microscope to use transmitted light on the grid slide provided with the system. The point of using a grid slide is to simplify the alignment process. The grid slide has several grids of different sizes that you can use depending on your microscope lens magnification:

- For 10x magnification please use the 200um grid
- For 20x magnification please use the 100um grid

Andor iQ How To Documents

- For 40x magnification please use the 50um grid. If the result is not satisfying, you can use the 100um grid instead.
- For 60x magnification please use the 50um grid
- For 100x magnification please use the 50um grid

Both sides of the acquired image should look similar to the following one.

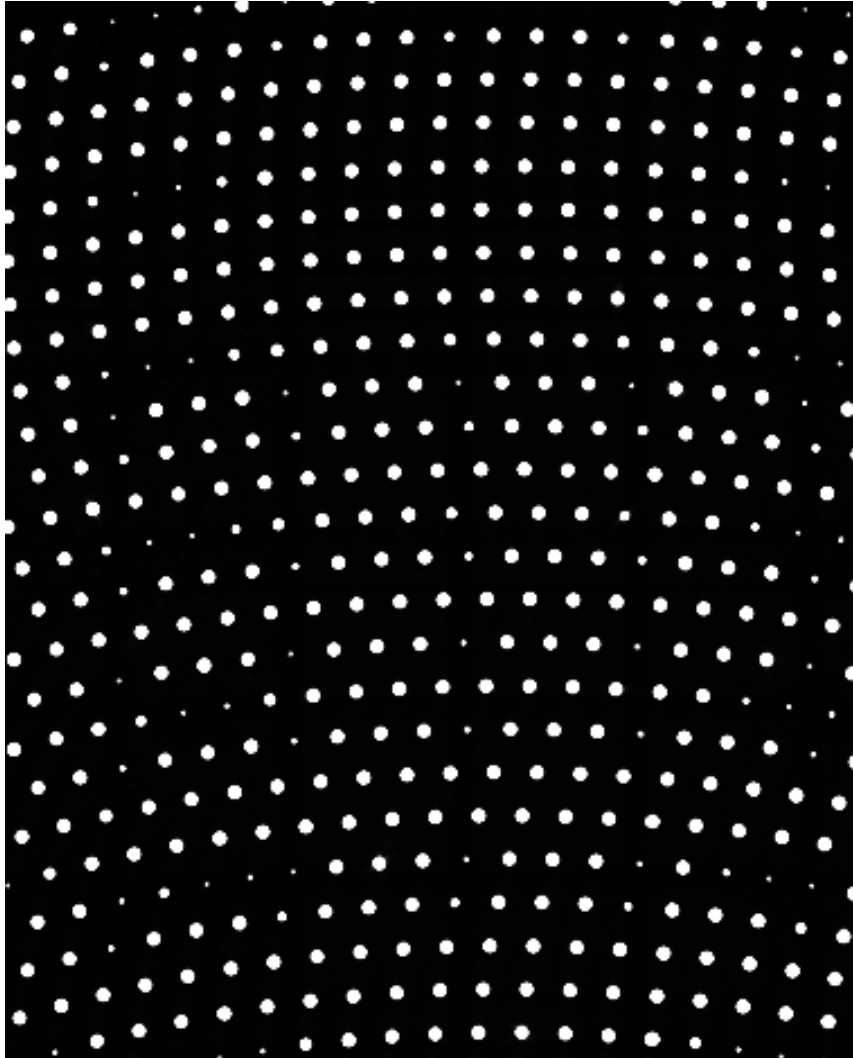

The dimmer circles correspond to areas where the grid lies. Please make sure that the grid is aligned properly (see following image for example) and that no circle is fully hidden. Once the image is acquired, please continue reading the “Calibration Process” section below.

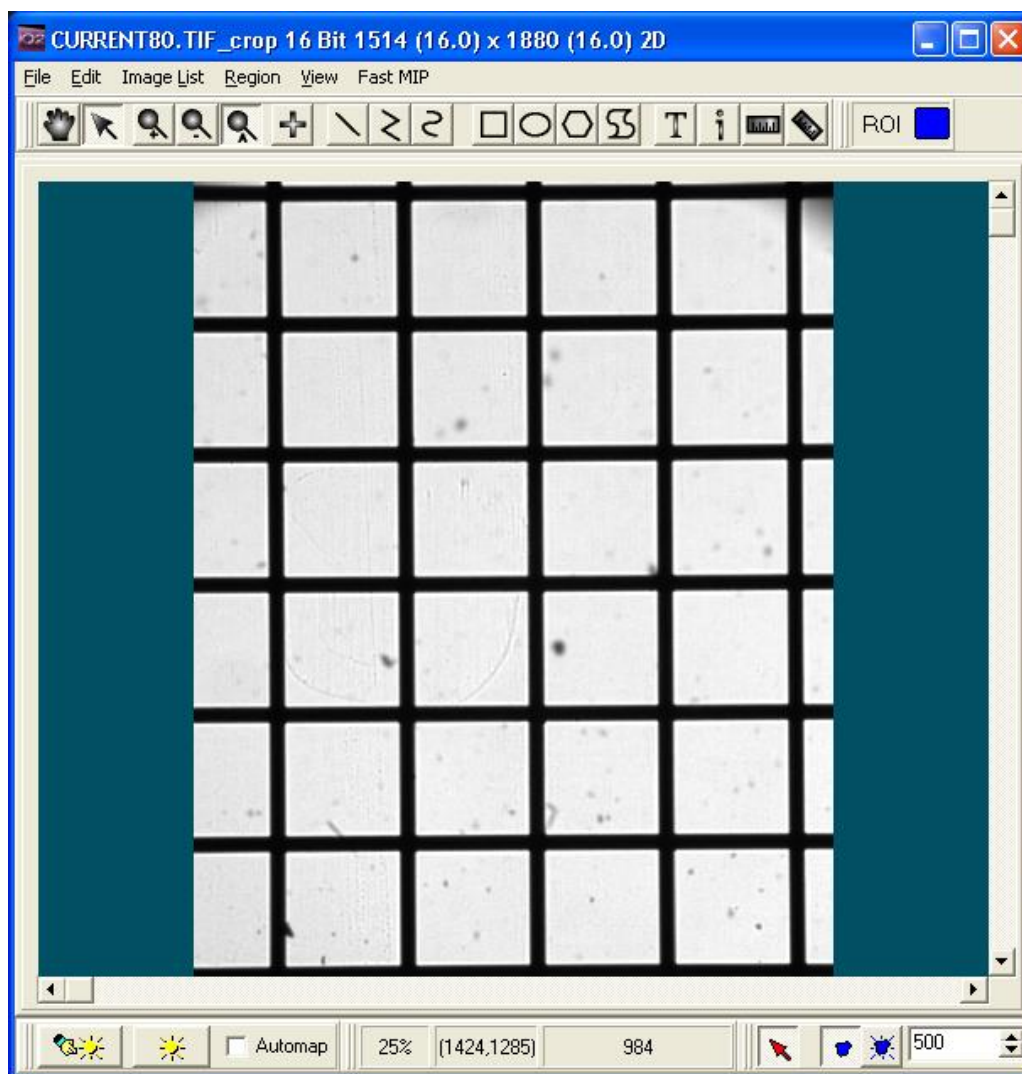

Calibration Process -

Once you load the calibration image in the Main Image Window you can start the process by pressing the Calibration button on the top-right of the Field Split Window. This will pop up the calibration wizard.

- 1) In the first step, you should specify a name for the calibration file. Alternatively, if you have previously created a calibration file for your current device settings you can load it from the list box.

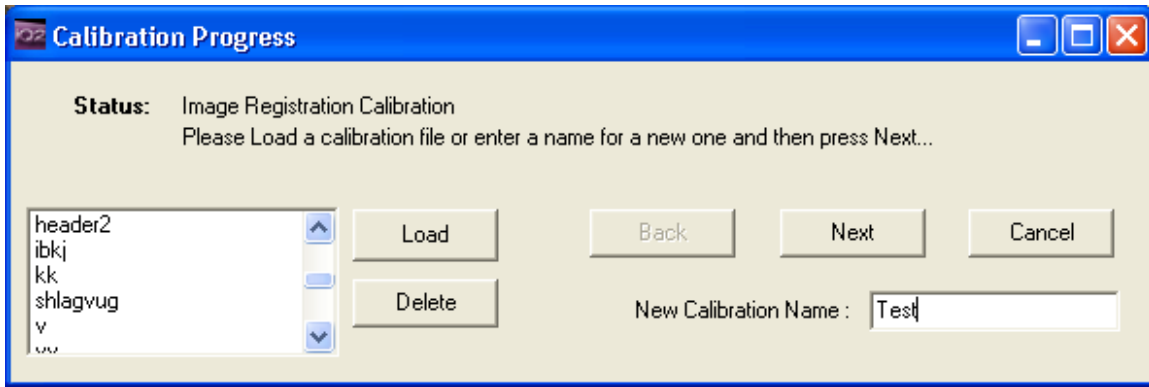

2) At this stage you should size and align the regions' ROIs (two to four ROIs depending on the selected mode) in your Main Image Window until the images overlap closely in the Field Split Window. You can move and adjust regions by selecting the pointer image tool on top of the Main Image Window. In order to

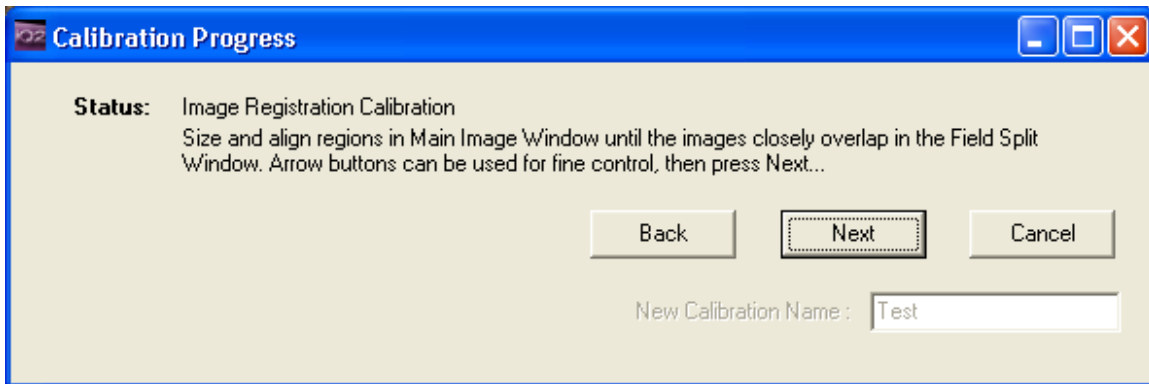

have more precise movement in your regions you can use the 4-way arrow buttons to shift the regions in one pixel increments. You can monitor the alignment of the images while you are moving regions on the Main Image Window through the channel preview image in the Field Split Window. This is easiest if the Multi check box in the Field Split Window is checked. Once you are happy with the alignment you can press Next to proceed to the next step.

3) At this step you should place a landmark in one of regions (ROIs) by clicking on a distinct feature; it is easiest to select a feature that is already quite well-aligned after adjusting the ROI positions. Clicking the feature will also automatically place a landmark on the other regions, taking into account the region positions and flip/rotate settings to try and find the corresponding points. However, if desired, you can still move each of the landmarks manually while you are at this

step of the wizard. You can zoom in to move your landmarks more accurately. Once you are happy with the landmark positions you can press the Next button to start the calibration process.

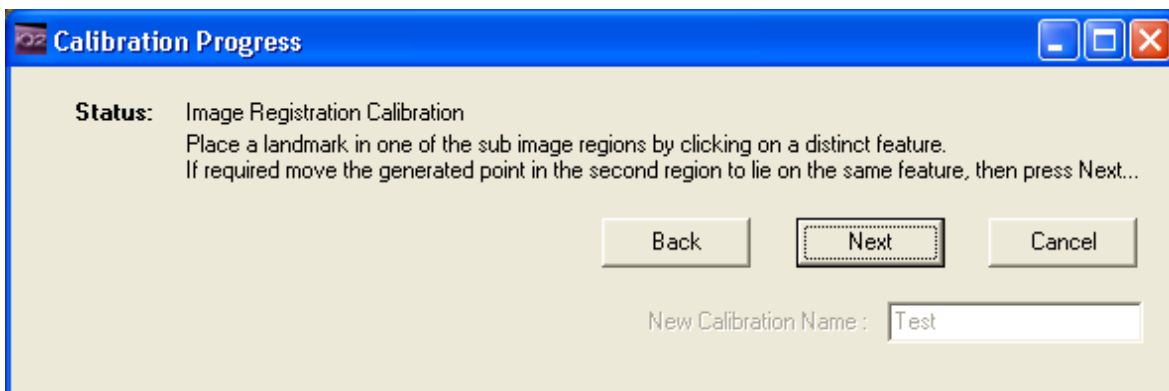

- 4) The calibration process may take up to several minutes. If you have already done the previous steps correctly the calibration process should be finished successfully, and pressing Finish will save the generated calibration file. If you want to abort the calibration process you can press the Cancel button at any step during the calibration wizard.

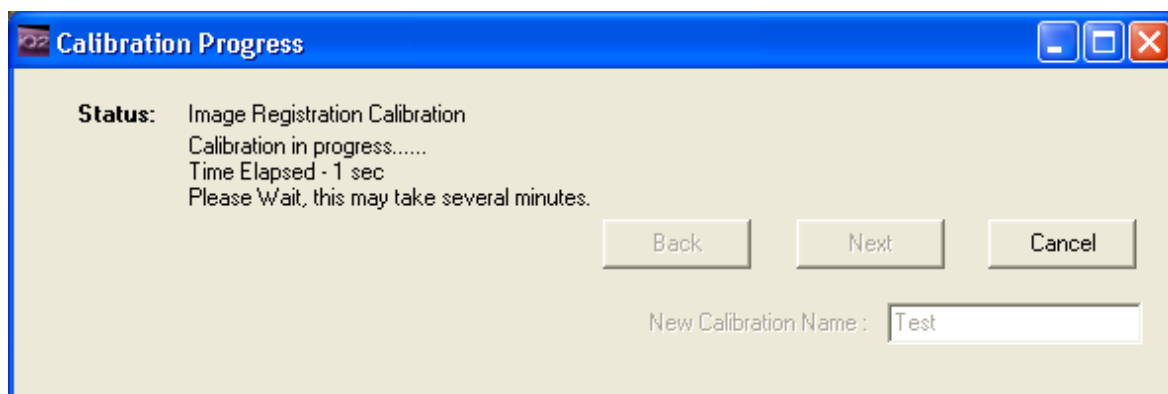

The generated calibration file will be applied and aligns the channel preview image in the Field Split Window. You can disable the calibration by unchecking the Enable check box in the Image Registration panel. Checking the Enable checkbox again will apply the generated calibration file to the result image.

You may see artifacts around the edges of the channel preview image in the Field Split Window. When you press the Process button on the top-left of the Field Split

Andor iQ How To Documents

Window these areas will be automatically cropped from your final result image and this image will then be saved into your image disk.

Note that since the final processing will crop away any artifacts, your final result image may be a few pixels smaller than your selected regions.

A5.24. Image Registration and creating calibration files for dual channel images in the Field Split plug-in

If you own a dual camera system with both cameras acquiring at the same time you will need to run two instances of iQ in parallel to acquire two simultaneous images. Your acquired images may not be exactly aligned; the Image Registration process can offer you a better result than using manual alignment. Before running any experiment that uses Image Registration you will need to create a calibration file using the below process. You will need to acquire a calibration image using both cameras.

Those images will need to be merged before you can run the image registration. For this you will have to use the Dual Image Disk. For more information on how to use the Dual Image Disk, please refer to section 6.13.

Required specifications for Images used for creating calibration file for Image registration -

The Image Registration algorithm works with 12 bit and 16 bit grey images only. In order to use the Image Registration algorithm and create a calibration file you should load a high contrast image in the Main Image Window.

If you own a Yokogawa CSU-W1, we recommend you to run the calibration on an image of the confocal spinning disk with the biggest pinholes. In order to acquire such an image, first stop the spinning disk. Once the disk has fully stopped, select the disk with the biggest pinholes, if your unit has different disks. Please see section A3.18 for more information on how to use the CSU-W1.

You will need to acquire a calibration image with both cameras. Before starting the acquisition, please make sure that the CSU-W1 is set the same way as it will be during your experiment. Set your microscope to use transmitted light on the grid slide provided with the system. The point of using a grid slide is to simplify the alignment process. The grid slide has several grids of different sizes that you can use depending on your microscope lens magnification:

Andor iQ How To Documents

- For 10x magnification please use the 200um grid
- For 20x magnification please use the 100um grid
- For 40x magnification please use the 50um grid. If the result is not satisfying, you can use the 100um grid instead.
- For 60x magnification please use the 50um grid
- For 100x magnification please use the 50um grid

Both images should look similar to the following one.

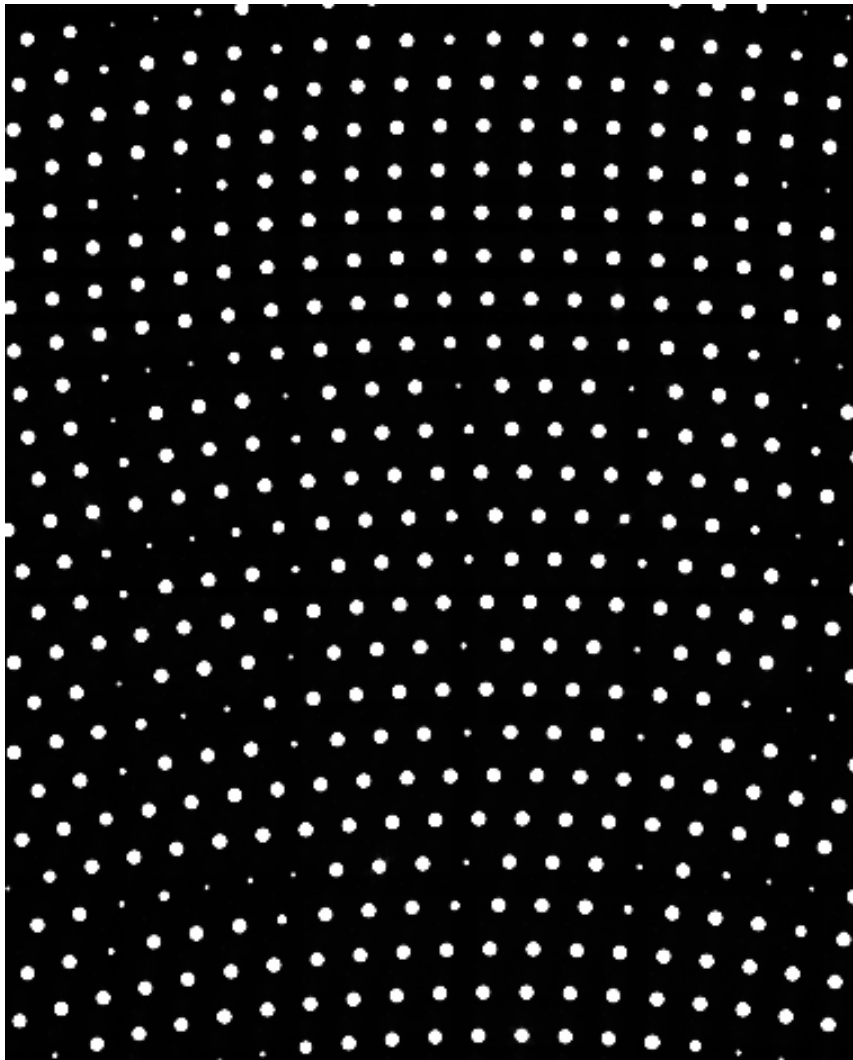

The dimmer circles correspond to areas where the grid lies. Please make sure that the grid is aligned properly (see following image for example) and that no circle is fully hidden.

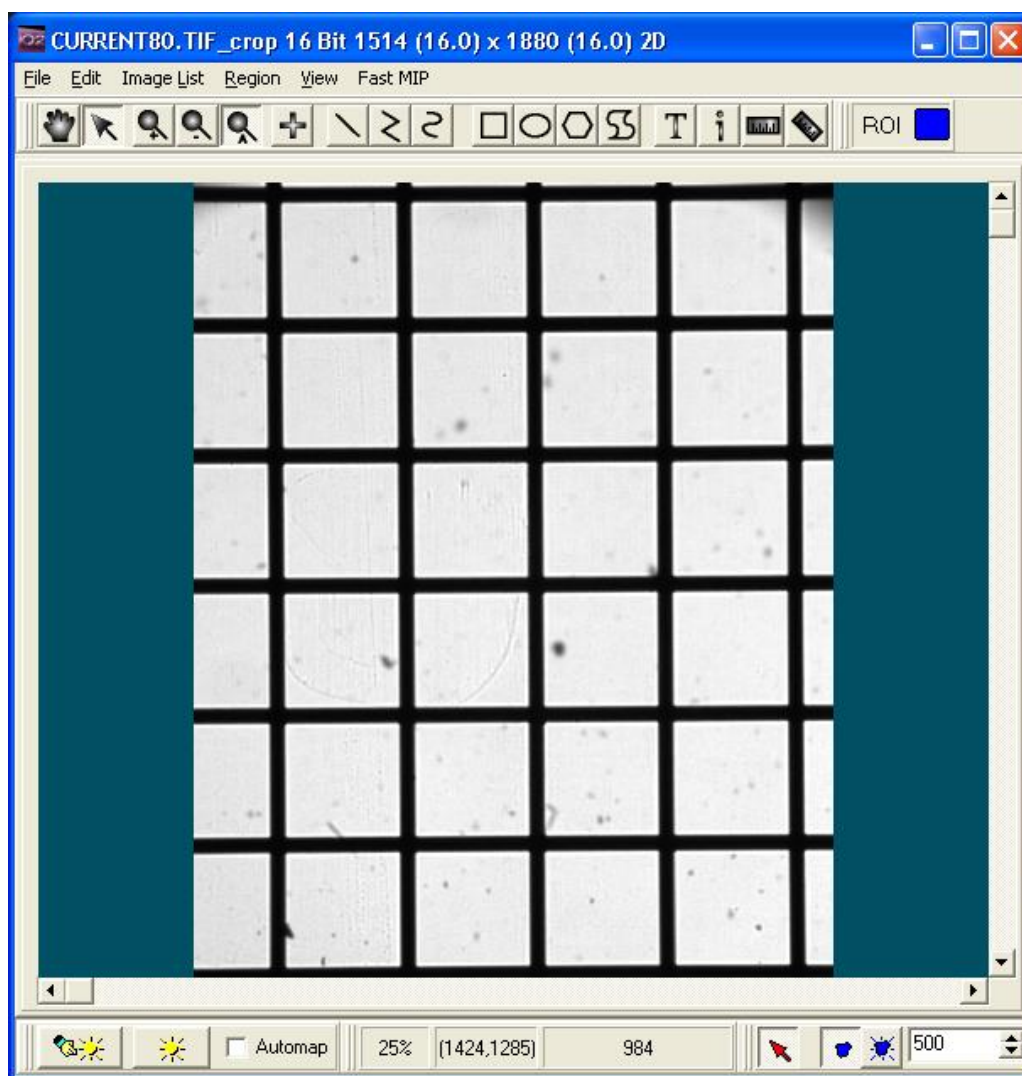

Once both images are acquired you should merge them using the Dual Image Disk plugin. If you need help on how to use the Dual Image Disk, please go to section 6.13.

It is important that you create and re-use a calibrated file from the same hardware configuration. For example you should create a calibration file for each emission split dichroic and associated emission filter combination (e.g. GFP/RFP dichroic with emission filters and CFP/YFP dichroic with emission filters each require a calibration file.)

Alignment and Calibration Process -

The Dual Image Disk will generate a dual channel image that can be then used in the Field Split plugin to run the Image Registration calibration. See “Calibration Process” in Section A5.23 for more information on this process.

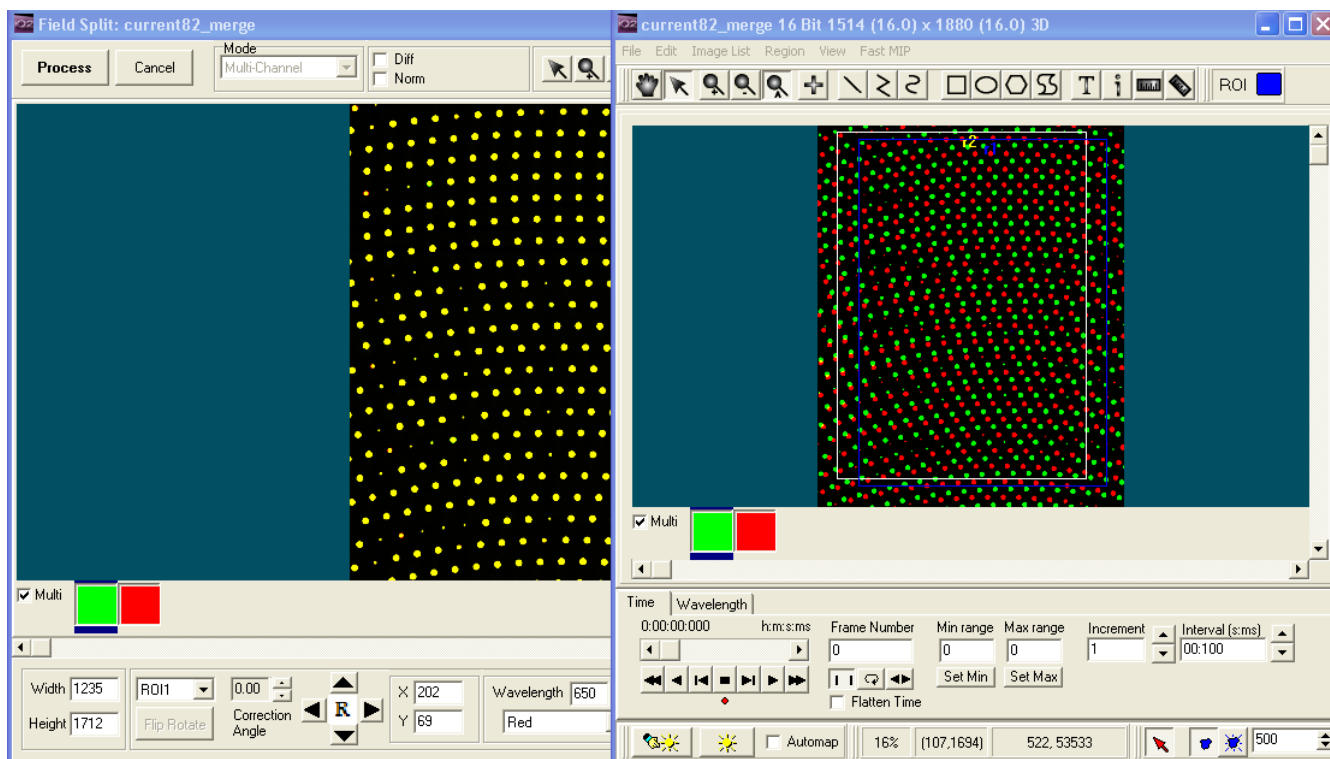

Warning: Take a note of which image you choose from the Local Disk list and which image you choose from the Dynamic Image Disk list. For example: choose the image acquired by camera 1 from the Local Disk and the one acquired by camera 2 from the Dynamic Image Disk. This will be useful when you will need to merge your experiment image.

Once you have merged your images you can finally use the Field Split plugin as described in the “Calibration Process” subsection. There is one main difference between the described process for single channel images and the process for dual channel images. In the latter case, both regions and both landmarks will be on top of each other. The blue region refers to the first channel while the yellow region refers to the second channel. When you need to move the regions and landmarks you can uncheck the Multi checkbox of the Main Image Window to only see one channel at a time. This makes it easier to define the proper position of the overlay.

Once the calibration process is done, you will be able to use the calibration directly in the Dual Image Disk plugin. Instead of simply merging the images like you did previously to prepare the calibration image, select the Image Registration option in the Alignment File panel and use the folder button to select your newly created calibration. Now, pressing the “Construct” button will not only merge your two images but also apply the Image Registration calibration so that the result image will have both channels aligned.

Warning: Make sure to select your images the same way you selected the calibration images previously; i.e., if you selected the calibration image acquired by Camera 1 from the Local Disk, you should also select the dataset acquired by Camera 1 from the Local Disk.

A5.25 “XD and FLIM” Andor iQ and Lambert LIFA Systems Interaction

A5.25.1. Background

Andor Technology (Andor) and Lambert Instruments (Lambert) have developed a solution combining the capabilities of Andor’s Revolution XD (laser spinning disk confocal) and LIFA (fluorescence lifetime) imaging systems. This document outlines the envisaged communications between the two parts of the system to support software and hardware control.

A5.25.2. System Overview and Control

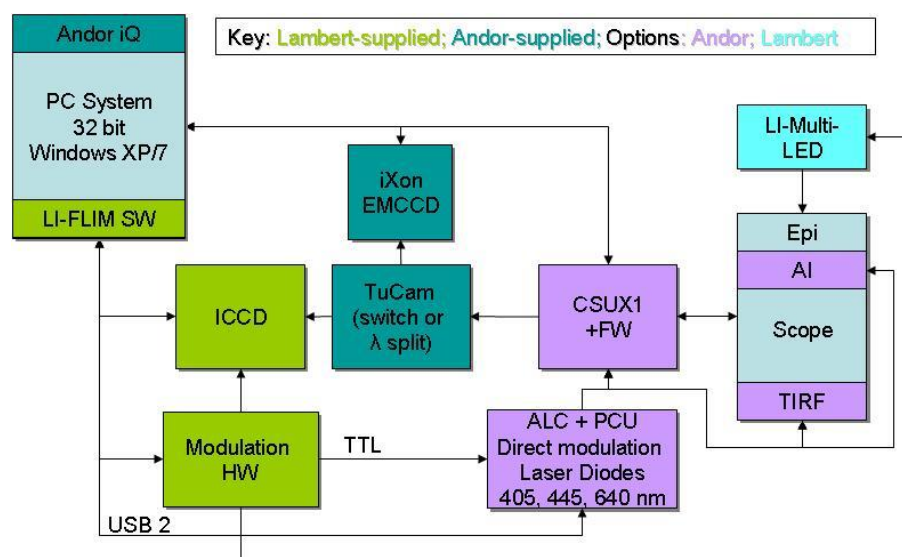

Figure 5.25.1 The XD-LIFA system will utilize many existing components from Pasteur. The system will be controlled with Andor iQ and LIFA software.

The system hardware configuration is shown in Figure 1. Essential components include (from left) PC workstation with Andor iQ 2.5.1 (or later) and LIFA software (version TBD), Lambert ICCD and Modulator, Andor iXon, TuCam, ALC-601 (with PCU) and CSU (10,22 or X1). A piezo Z device or microscope motorized focus can be used for Z scanning and a motorized XY stage may be optionally available for multi-field or multi-well imaging.

Andor iQ How To Documents

When operating in XD mode the system will acquire multidimensional fluorescence intensity and wavelength encoded images. In XD mode, Andor iQ will control the iXon, ALC, CSUX1 and piezo Z and motorized XY and microscope if available. The TuCam is a manual device to switch between iXon and ICCD.

In FLIM mode the LIFA software will acquire and compute frequency domain fluorescence lifetime images with control of Lambert's ICCD, Modulator and modulate the ALC via TTL.

In the envisaged model, we assume that Andor iQ will retain basic control of the ALC and switch its state based on TTL or software input from the LIFA system.

If multi-dimensional FLIM imaging is needed, we envisage that LIFA will manage FLIM imaging and will simply signal iQ to control the remaining system hardware sequencing.

The interaction between LIFA and Andor iQ can be achieved in various ways including:

- single or multiple TTL signals – assuming LIFA has at least one TTL output. Note that PCU provides 8 TTL inputs and 8 TTL outputs to facilitate system synchronization.
- Motivated user could exploit an inter-process control (IPC) interface – yet to be defined. Various options exist for IPC including
 - Python interface between LIFA and iQ – iQ has a Python IDE
 - COM interface – iQ COM enables channel query and setting
 - An SDK for the ALC exists - LIFA software development effort is required here.

In the examples which follow, we show example iQ Protocols to illustrate how TTL communication can be by LIFA to set the ALC state as required.

A5.25.3. Interaction between LIFA and Andor iQ via TTL

Andor iQ has a flexible nD Protocol Tree which provides a user interface for configuration of image acquisition sequences. The Protocols are made up of Channels, which store illumination and other hardware settings for acquisition, Scans, which define X,Y and Z position and range settings and Timing loops. Other commands support actions such as photo-stimulation and synchronization. We will illustrate the use of the TTL inputs and outputs to synchronize iQ with LIFA. For more details on creating Channels, Scans and Protocols see the iQ 2.X user guide.

In the hardware Configuration of Andor iQ we have selected an array of devices to illustrate operations from simple to complex, but the synchronization between iQ and LIFA remains very simple. Andor iQ must have a Kinetic Trigger device loaded in order to exploit the TTL synchronization capability. Use the Configuration Manager to specify the necessary hardware list – as shown in Figure 5.25.2.

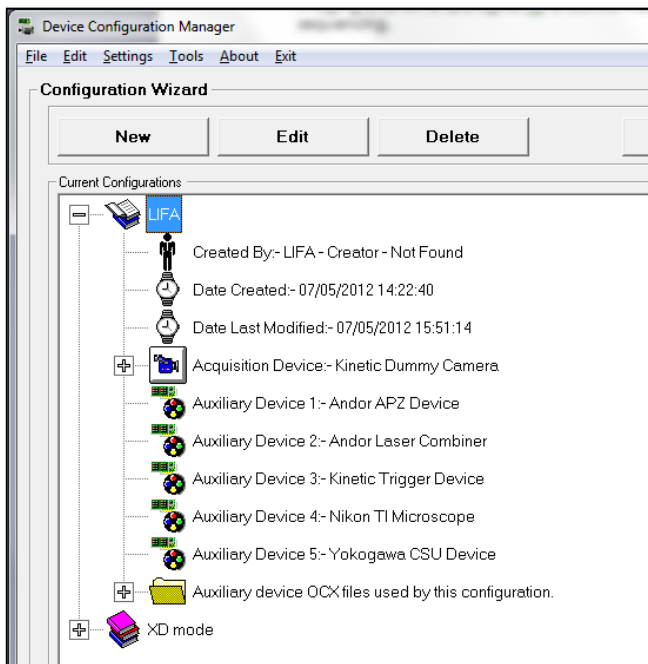

Figure 5.25.2

The Configuration Manager creates configurations of hardware for various instrumental modes.

In this case the configuration named LIFA include camera (dummy for illustration), piezo Z, ALC, Trigger, Nikon TiE and Yokogawa CSU. These devices are typical for the XD-LIFA system.

When Andor iQ starts up make sure that the hardware devices are attached and functioning. Check with the iQ User Guide if you have questions.

A5.25.3.1 ALC TTL modulation for FLIM imaging

To ensure that LIFA can control a selected ALC laser diode, the laser must be set into External TTL mode. This can be achieved in 3 steps. External TTL is not available for DPSS lasers – they are not capable of this mode of operation.

- i) Access the AOTF tab from the Device Manager dialog - see Figure 5.25.3a.
- ii) Click the Laser Status button - the ALC Info dialog will be shown – Figure 5.25.3b
- iii) Select External TTL in the External Laser Control drop down – Figure 5.25.3b.

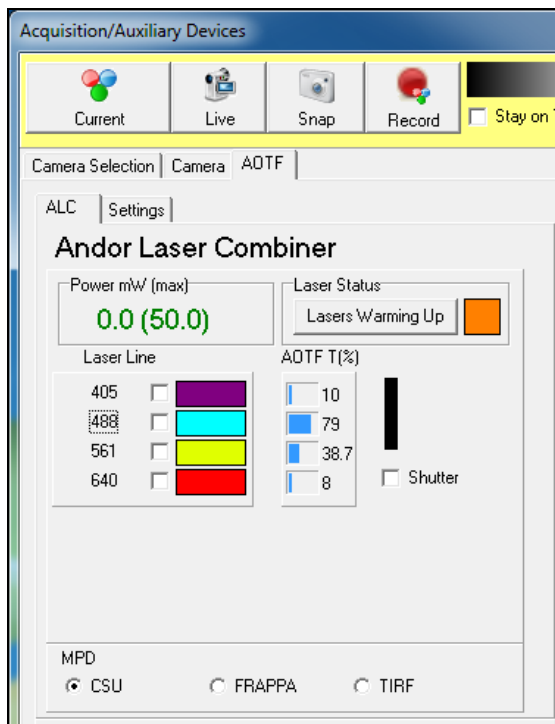

Figure 5.25.3. User setting of laser diode control for LIFA FLIM modulation.

ALC GUI in the Device Manager.

Laser Status button accesses ALC Info dialog Drop Down box for setting External Laser Control on individual Laser tabs.

Note that the Shutter checkbox must also be selected for laser emission.

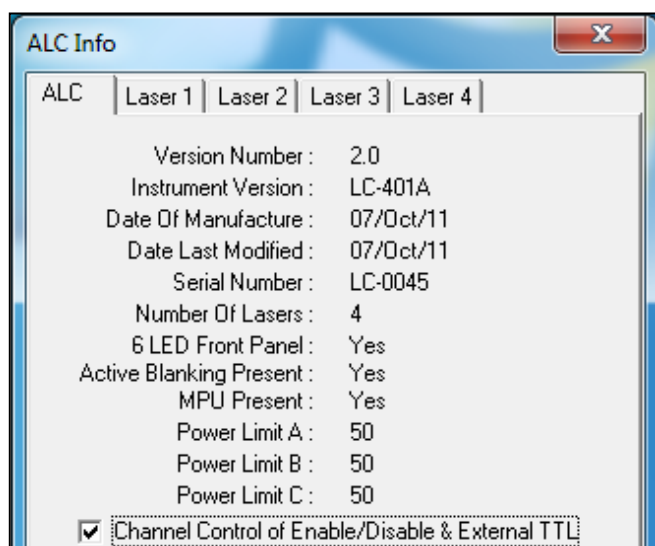

Figure 5.25.4. When automatic switching between diode lasers (for wavelength control) is required, you must select the Channel Control checkbox on the ALC tab as shown here. This will ensure that when a Channel is selected the appropriate laser diodes will be switched into their correct states. This is important because the LIFA modulation input on the front panel of the ALC (see Figure 5) is shared by ALL laser diodes, and the External TTL Control setting determines which lasers respond to the modulation.



Figure 5.25.5. Andor's laser combiner product family includes from bottom:

- ALC-601 FLIM-ready laser combiner;
- PCU precision control unit for AOTF control and system synchronization;
- MPU multi-port controller providing delivery of co-lineated laser power to 3 ports for e.g. CSU, TIRF and FRAP operation.

Andor iQ How To Documents

Highlighted in red is the External TTL input which is shared by all laser diodes. Channels select which laser will be used for FLIM by recording the External TTL control setting. Rear Panel Active Blanking switch setting should be OFF.

Manual control of the above settings, selection of the Shutter checkbox and connection of the LIFA modulation controller to the ALC External TTL input shown in Figure 5 (via 50 ohm BNC connection) will allow the system to be used in FLIM mode.

A5.25.3.2 Andor iQ Channel control for FLIM imaging

As specified in Figure 4, automatic switching of diode laser (and wavelengths) for FLIM imaging, can be achieved by using different Channels, so long as the External TTL Control setting for each diode laser is recorded in each Channel. To do this the Channel Control checkbox must be selected as shown in Figure 4.

We show here how to create a Channel for 640 nm FLIM imaging using iQ to choose the Channel and LIFA to modulate the laser and acquire the frequency domain images.

Step1 Channel Manager

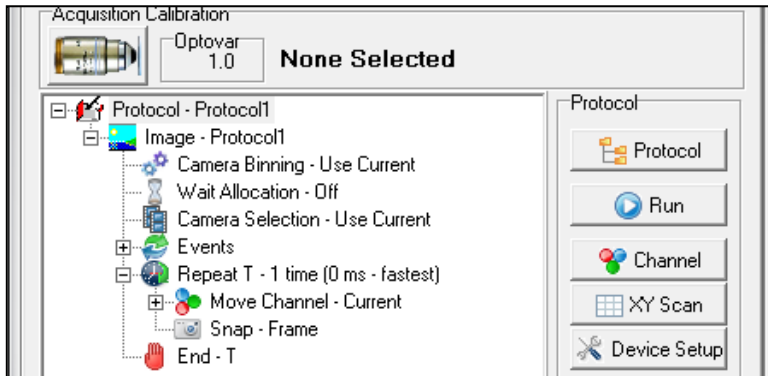

Figure 5.25.6.

Click on the Channel button in the Acquisition tab of the Control Window. This will show the Channel Manager.

Step2 Create a Channel

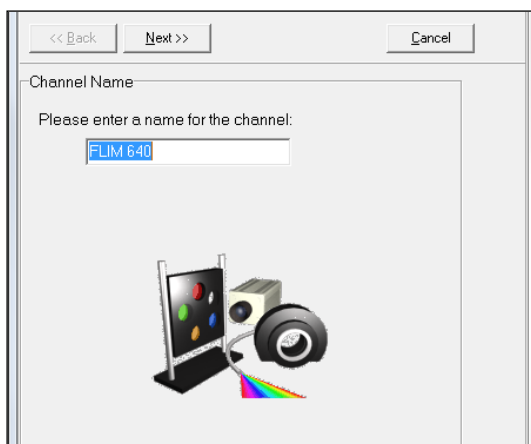

Figure 5.25.7.

Give the Channel a name in this case "FLIM 640".

Step3 Set Devices to Desired States

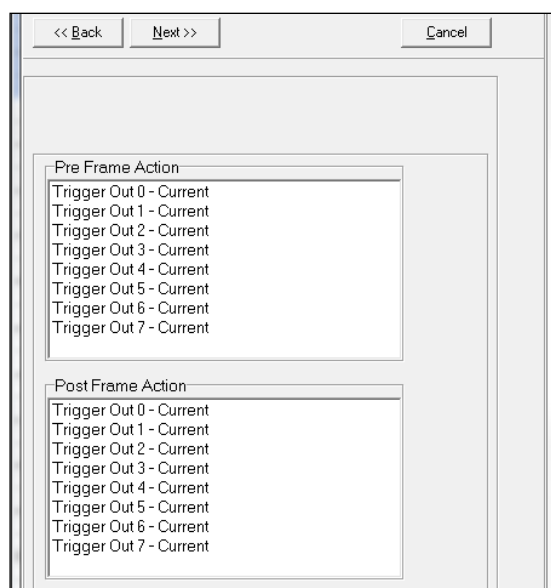

Figure 5.25.8.

In this Step we proceed through every device in the Configuration to set their desired state in the Channel.

The Trigger Device can be associated with Pre-Frame and Post Frame Events, but in this case we can leave signals in their default or Current state.

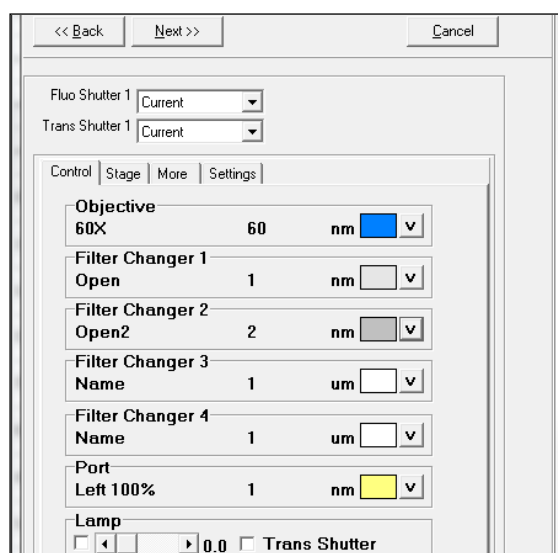

Figure 5.25.9.

Nikon TiE - A 60X objective is used and Filter Turrets set to Open positions to pass laser light for excitation. The Left photo-port is selected with 100% transmission,

CSUX is set with Shutter Open and appropriate dichroic, which will pass 640 nm lasers.

The emission filter wheel position ensures the correct emission filter is used for detection of the desired fluorophores.

CSUX and filter wheel dialogs are not shown for brevity.

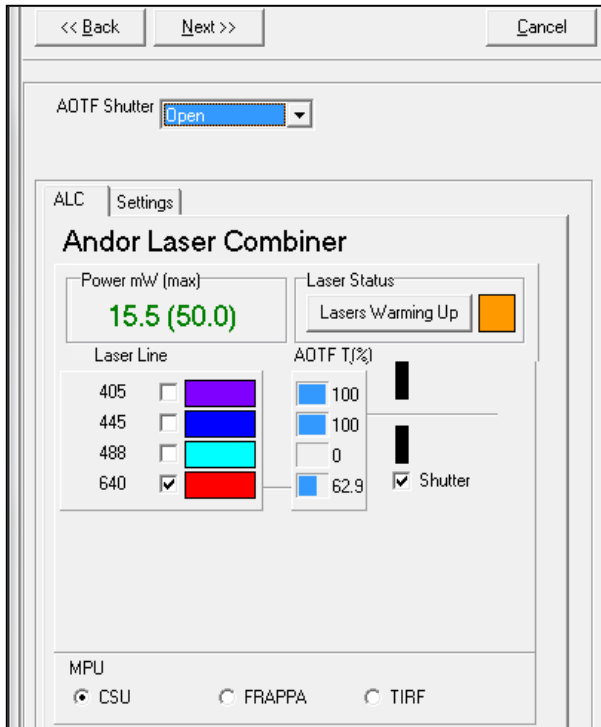

Figure 5.25.10.

The ALC settings are configured as shown. AOTF shutter should be Open to ensure laser emission under TTL control.

Laser Power level can be set as desired and at a level suitable for your specimen and instrumentation.

The MPU Port (bottom of dialog) should be specified for the desired microscope imaging

modality. In this case the CSU port is selected.

Note that the Power settings is rated relative to a maximum allowed power at the fiber optic input. Excessive power can damage the fiber due to overheating. This is typically 250 mW, though 50 mW is shown in this example.

Click the Laser Status button and make sure that the 640 nm laser is selected for External TTL Control and that the Channel Control checkbox is selected as shown in Figures 3b and 4 respectively. Also ensure that other laser diodes (405 and 445 nm in this case) are set to Internal.

Finally you will see a camera settings panel for this Channel – “FLIM 640”. Leave it on default settings, since you will not be acquiring images with this Channel, but using it in a Protocol and we shall see later to automatically select the FLIM laser settings for LIFA software.

Step4 Other FLIM Channels

When you create other Channels such as “FLIM 405” and “FLIM 445”, you will make sure these lasers are setup in a similar manner to 640 in this case.

Step5 Normal Fluorescence Channels

For normal fluorescence Channels set the laser diodes to Internal control, but again select Channel Control ON.

Step 6 Selecting Channels – switching laser states for FLIM

Using the Device Setup dialog, you can now manually select Channels and have these configure the laser diodes for FLIM imaging. Figure 11 a) and b) show this for Channel “FLIM 405” and “FLIM 640”.

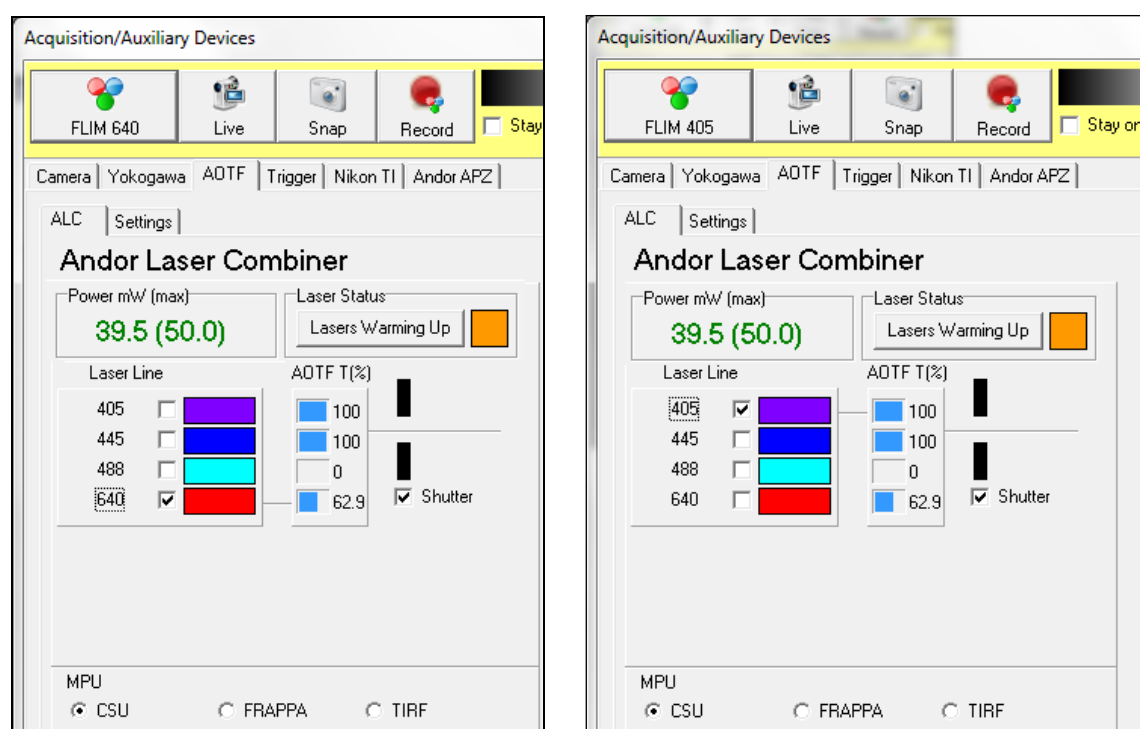

Figure 5.25.11.

The Device Setup dialog allows manual selection of Channel settings.

- a) Settings recorded for FLIM 640 switches the 640 nm laser to External TTL control and Opens the AOTF shutter.
- b) Settings recorded for FLIM 405 switches the 405 nm laser to External TTL control and Opens the AOTF shutter.

A5.25.3.3 Andor iQ and LIFA – Protocols for FLIM imaging

As mentioned previously we can use iQ Protocols and TTL Trigger inputs to sequence FLIM imaging. Figure 12 shows how this can be achieved in a simple time lapse Protocol. We will discuss in detail how to configure and name Triggers in the next section.

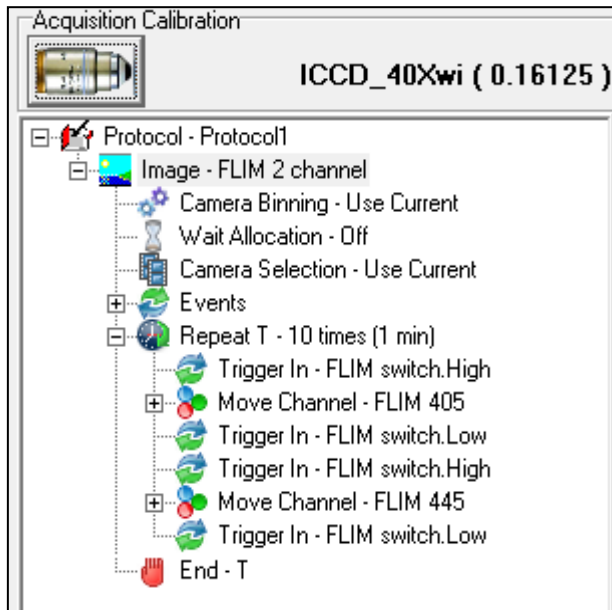

Figure 5.25.12.

In this Protocol iQ will not capture images, but act as a triggered device controller.

The action starts at Repeat T where 10 cycles are specified with an interval of 1 minute.

Trigger In waits and monitors input “FLIM Switch” until it goes High (TTL=“1”). We expect LIFA

to issue the TTL signal to allow this transition.

Next iQ Moves devices to their states for Channel “FLIM 405”.

The laser diode is now ready for TTL modulation and FLIM imaging under LIFA control at 405 nm.

After the FLIM image has been captured, LIFA must “handshake” to confirm it is ready and iQ waits for Trigger In - FLIM Switch.Low.

Next iQ waits for Trigger In - FLIM Switch.High to proceed to Channel FLIM 445 and so on.

The high-low transitions on Trigger Input - FLIM Switch synchronize the two systems. As we proceed through the logically through sequence you will see that iQ waits for a transitions from high-to-low and low-to-high as permission to switch lasers states. This sequence enables 3 channel, time-lapse, FLIM imaging.

A5.25.3.3.1 Setting up the Trigger Inputs and Outputs

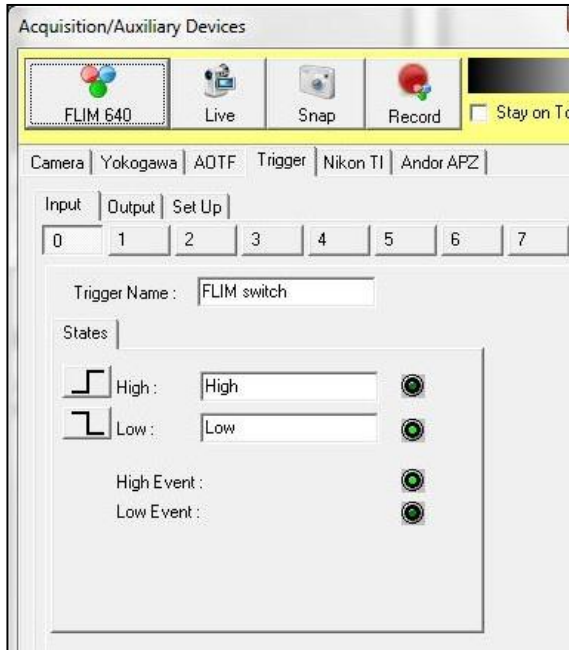

Figure 5.25.14.

The Trigger device is accessed from the Device Setup dialog. It has 3 tabs.

Setup defines which DAC or DIO control card it should use for TTL IO. In an XD LIFA system this will normally be DDA06/16, but can include DIO24. These controllers provide 8 TTL inputs and Outputs.

Inputs and Outputs are configured on the tabs shown. The High and Low States buttons can be used to manually set the TTL input and Output States for testing.

To make the IO channels easier to interpret you can provide user-defined names. To do this you will need to Unlock the dialog with the “padlock button” at the bottom right of the dialog. IN this case we chose FLIM switch as the name for Input 0.

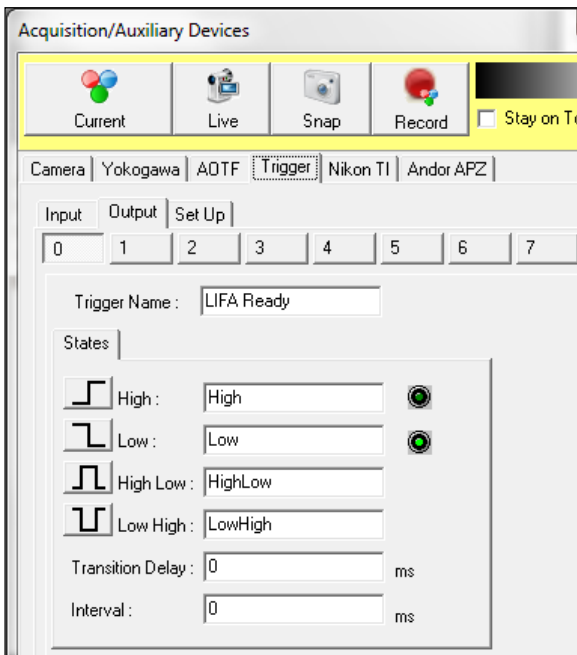

Figure 5.25.15

Shows the output side of the Trigger device has additional controls. As well as setting the output state to High and Low, the output can be pulsed and also has properties - Transition Delay and Interval. Pulses can be of either polarity and the properties define the pulse width = Interval + 2 * Transition Delay.

Transition delay is commonly used when an external device has a significant switching time e.g. a mechanical shutter. iQ will wait after setting the Output state for the period equal to the value specified in the Transition Delay. This enables the system to maintain synchronization in a wide range of cases. Transition Delay is used at either or Transitions – see pulse mode above.

A5.25.3.3.2 Building and Editing Protocols

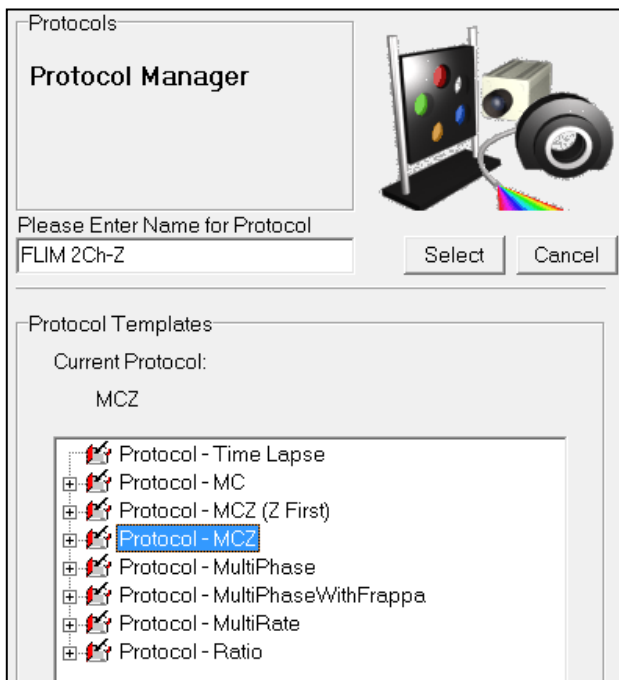

Figure 5.25.16.

Andor iQ produces Protocols in various forms, but the user is free to add Trigger actions, scans and other steps at will and then record the Protocol for future use. The Protocol Manager is accessed from the Protocol button on the Acquisition tab in the Control Window. The Protocol Manager offers a “New” button which

simplifies Protocol creation and is shown here. In this case we have named the Protocol FLIM 2CH-Z to indicated a 2 channel FLIM data set with Z scan.

The resultant Protocol is shown in Figure 5.25.17

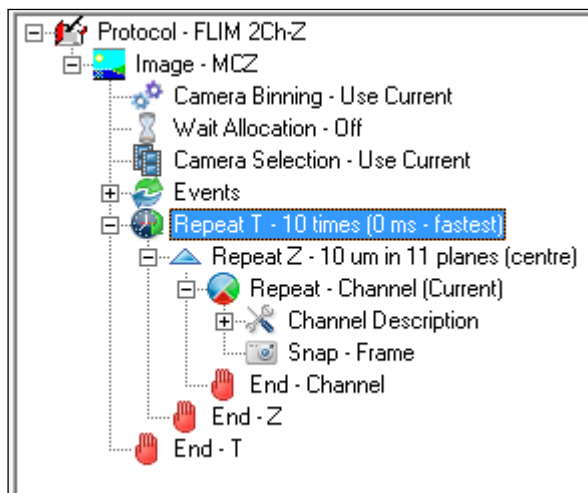

Figure 5.25.17.

The Protocol created by iQ as Type MCZ (multi-channel Z). This is a time-lapse multi-channel with a Z scan at each wavelength and at each time position. The defaults are number of time points 10, Z scan range 10 microns and Channels “current”. Current refers

to the current channel settings whatever they may be. In order to make this work with LIFA we must use some of the Trigger IO tricks that we discussed in the simpler Protocol of Figure 12. To make changes to the Protocol you simply click on the key word above the location for inserting and then click the

right mouse button as shown in Figure 5.25.18.

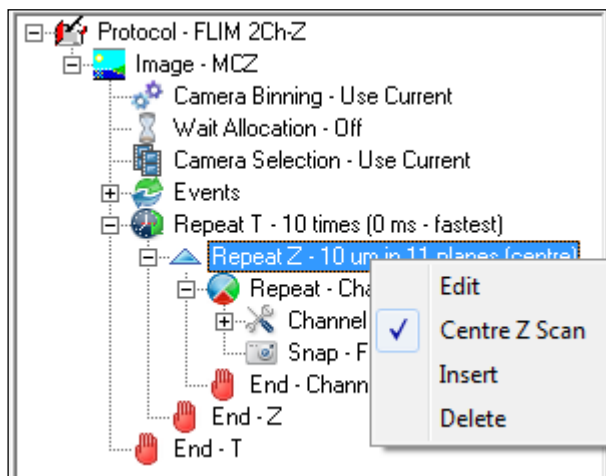

Figure 5.25.18.

In order to change the Z scan select it with a left mouse click then right mouse click and select Edit. A Z scan Wizard will be shown and the user can interactively set the Z range and step size or number of steps.

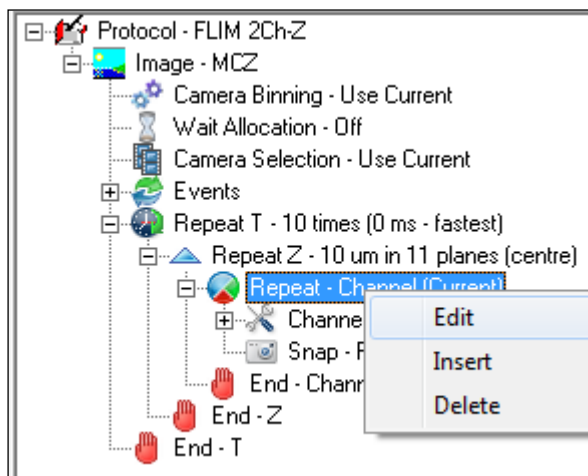

Figure 5.25.19

To change the Channels to FLIM Channels we click on Repeat Channel and select Edit. You will be shown the dialog of Figure 5.25.20 – follow the instructions in that figure.

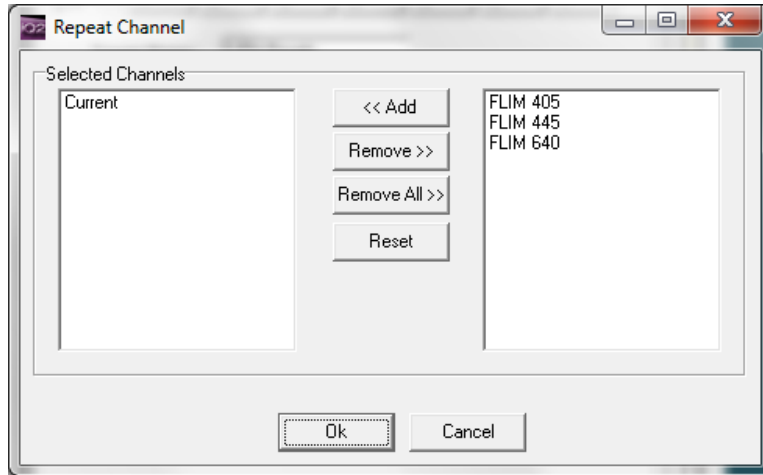

Figure 5.25.20.

Specify the Channels you want to use in the Protocol. Select Current on the LHS and click Remove. Then click on FLIM 405 and click Add, then click on FLIM 640 and click Add. Finally click OK and the new Channels will appear in the Protocol as shown in Figure 5.25.21.

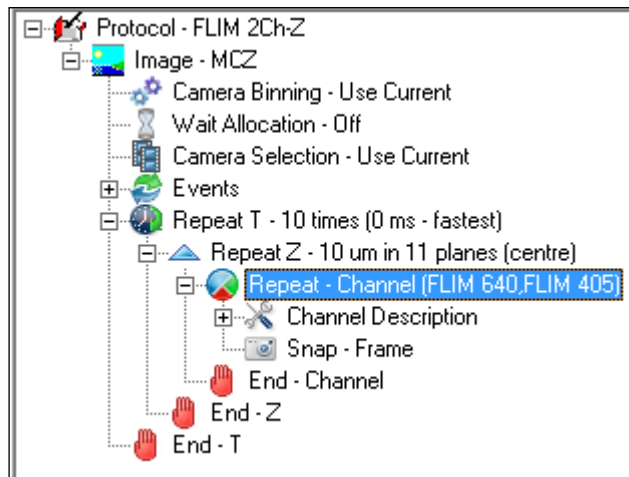

Figure 5.25.21.

The Protocol now contains FLIM 405 and FLIM 640 channels. . To add the Trigger IO actions to synchronize with LIFA, you should now select the Repeat Channel action and right mouse click. Now choose Insert from the popup menu

and you will see the Action object list shown in Figure 5.25.22.

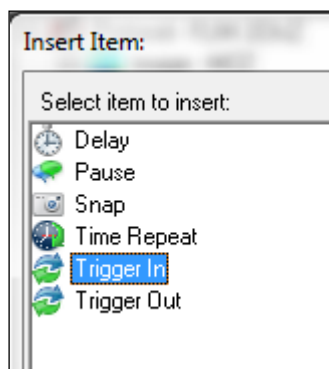

Figure 5.25.22.

Action objects include the Trigger In and Trigger Out options. Choose the Trigger In action and you will see a Select Trigger dialog as shown in Figure 5.25.23.

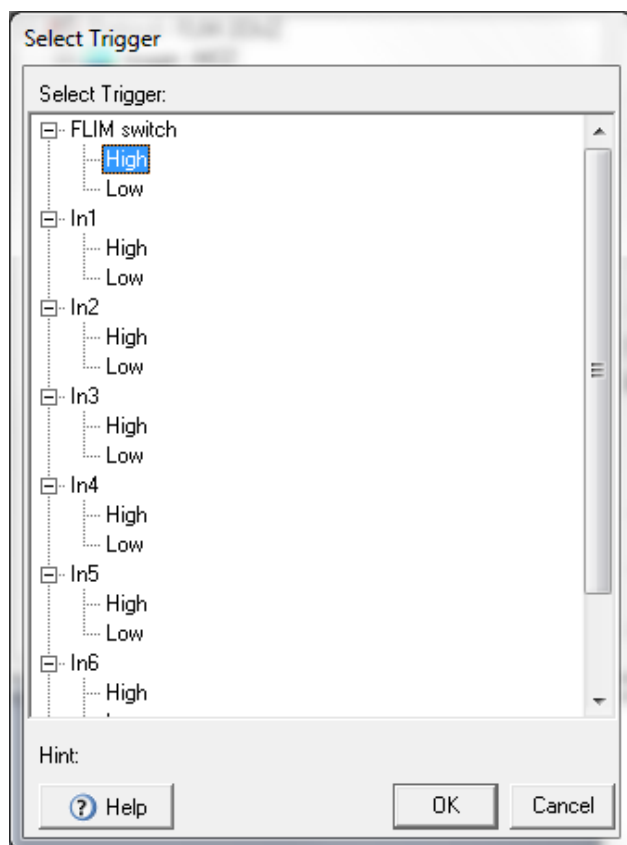

Figure 5.25.23.

This dialog lets you choose which input signal and which state you will use to “gate” or test prior to the Channel state change. If you choose “FLIM switch.High” as shown this will be similar to our earlier Protocol.

Repeat this Insert step so that you have two Trigger In actions inside the Repeat Channel loop, the second one should use “FLIM switch.Low” like our simple Protocol.

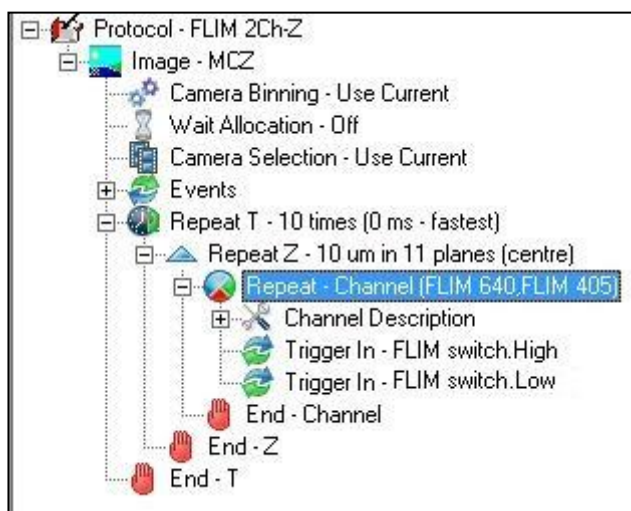

Figure 5.25.24.

The resulting Protocol now looks like this and is ready to run with LIFA. Note that we have also removed (Delete) the Snap action, since we do not wish to acquire any data in this case with iQ, but instead with LIFA. iQ again acts as a triggered sequencer.

With this Protocol LIFA will acquire a time lapse of 2-channel Z series FLIM images.

A5.25.3.4 Andor iQ and LIFA – Protocols for Intensity and FLIM imaging

This requires a “Pause” command to allow the user to switch the TuCam.

And of course we could use emission wavelength dichroic splitting.

Following is an example protocol with both FLIM and Confocal. Steps for generation are as defined in previous section. The pause command allows the user to manually switch the TuCam to the appropriate camera.

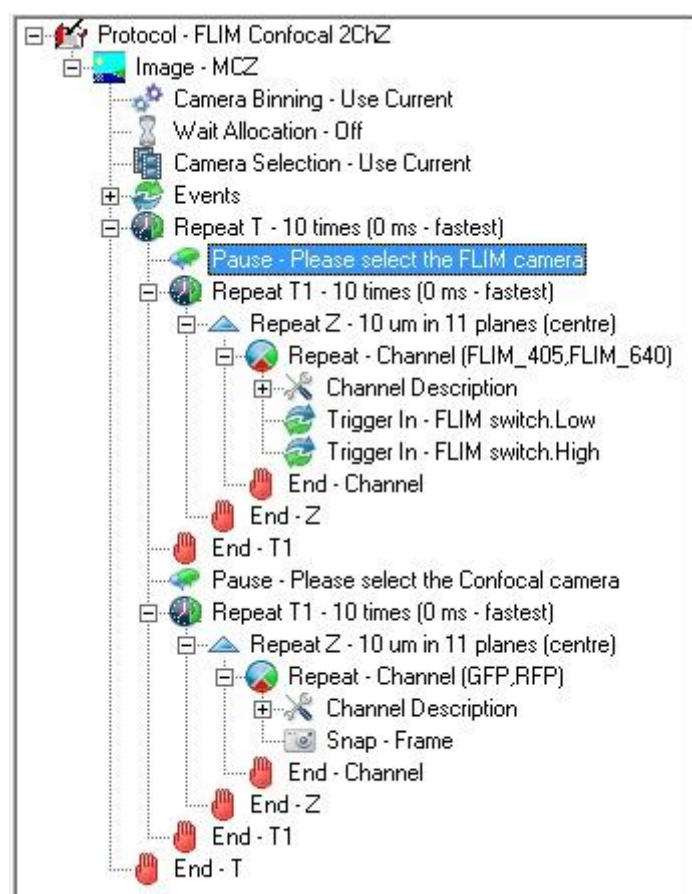
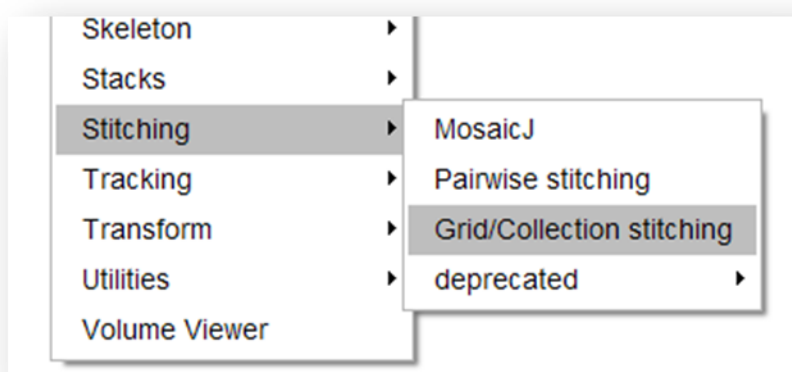

Figure 5.25.24

A5.26 Montage/Stitching using FIJI

1. Download and install FIJI (“Fiji is just ImageJ”).
2. Save your montage from iQ as TIFF single image files
3. Run the **Grid/Collection Stitching** plugin in FIJI (from the Plugins menu):



4. Select “Row by Row” and “Right & Down” (I believe this is default):

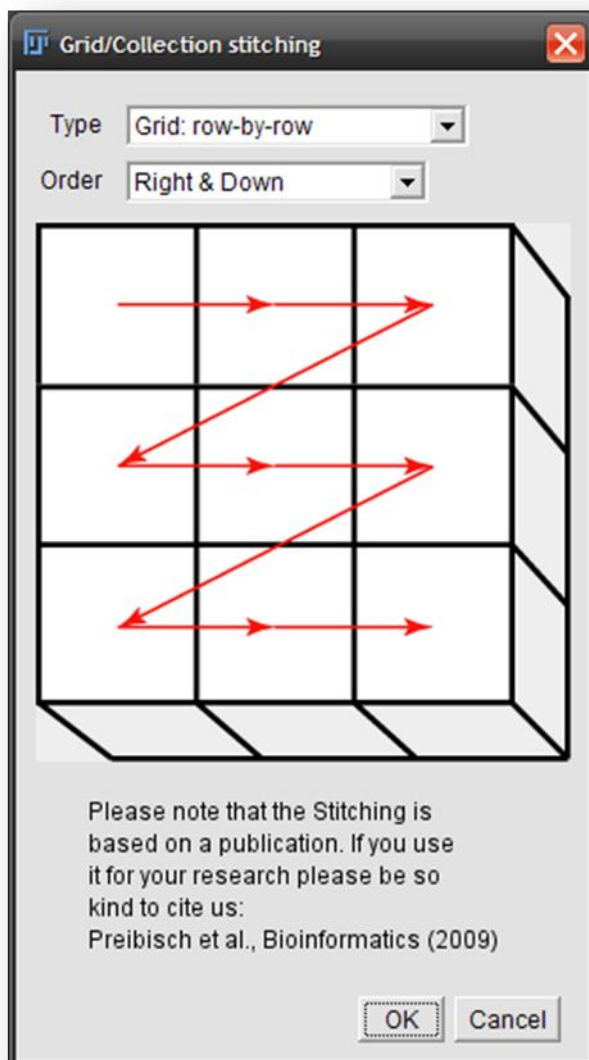

5. Input the grid size in X and Y and an overlap equal to or greater than the setting that was used in iQ:

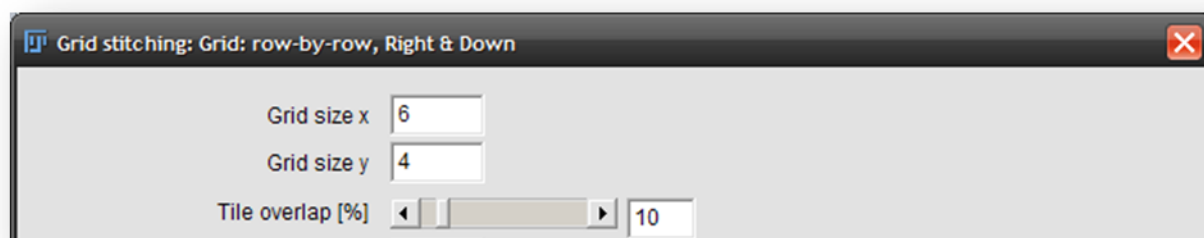

6. Select the first file index as 0 (zero), Browse to the directory containing the images and input the filename:

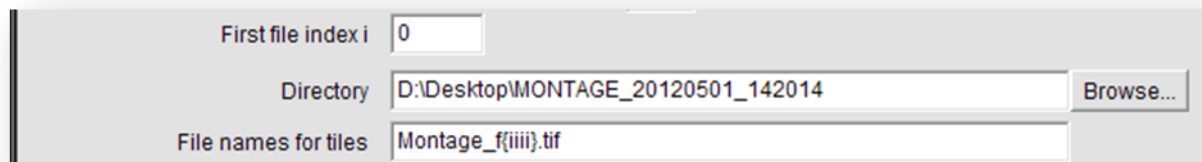

First file index i	0
Directory	D:\Desktop\MONTAGE_20120501_142014 Browse...
File names for tiles	Montage_{iiii}.tif

For example, in the above screenshot, the common file name is “Montage” and iQ, by default, will extend the filename with “f_xxxx” where xxxx is the four digit number of the field, for example *Montage_f0000.tif*, *Montage_f0001.tif* etc.

In the Grid/Stitching plugin, this is represented with the letter i for each digit.

7. Pressing OK will start the process of warping, rotating and matching

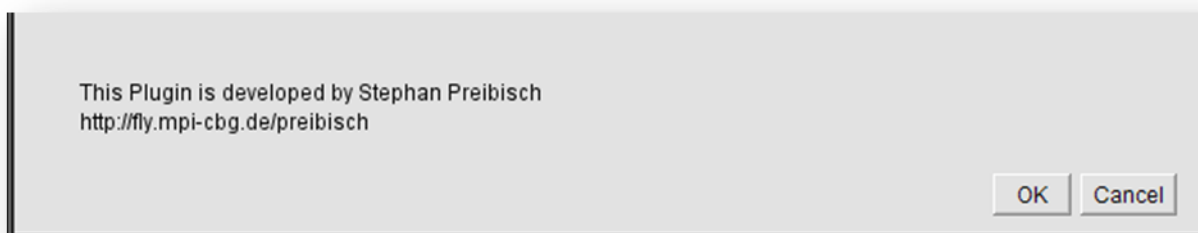

the images.

A5.27. Importing protocols from other users or older versions of iQ

The Protocol Importer plug-in can be used to copy protocols from another user, and to import your old protocols from a previous installation of iQ2.

Select the Protocol Importer plug-in from the Settings menu. You can now choose where you want to import from. The top drop-down menu lets you select any user to import protocols from. You can also import protocols created while user accounts are disabled, by choosing "<non-user-specific>" from this menu. If you want to import protocols created in iQ2, you can do that by selecting "<iQ2 legacy>".

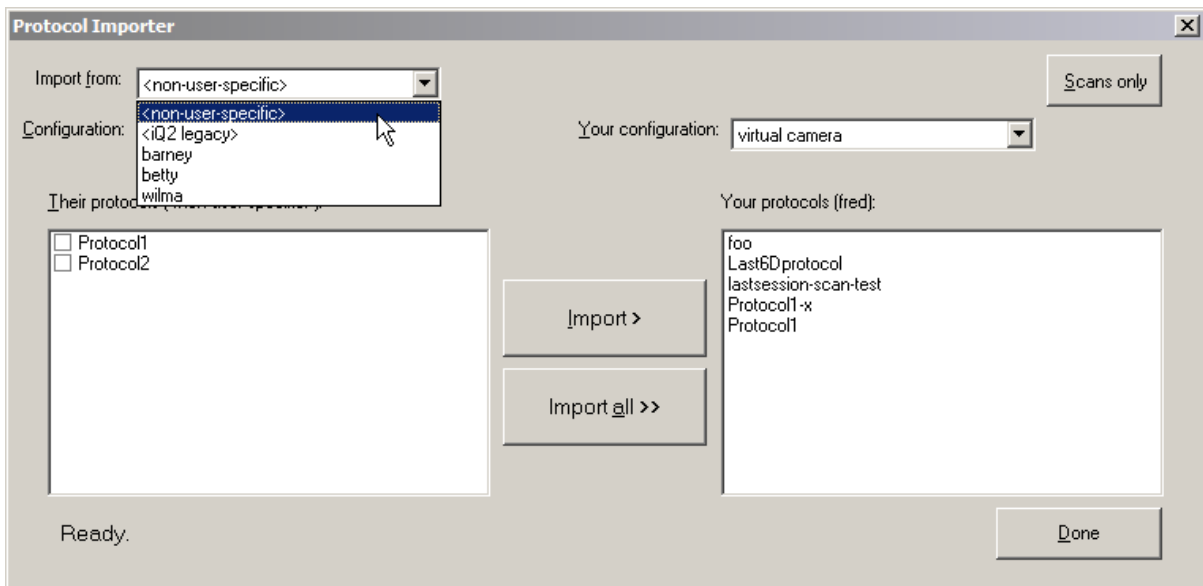

Choose which of that user's configurations you want to import from. The list of protocols in that configuration will then be displayed in the large box on the left.

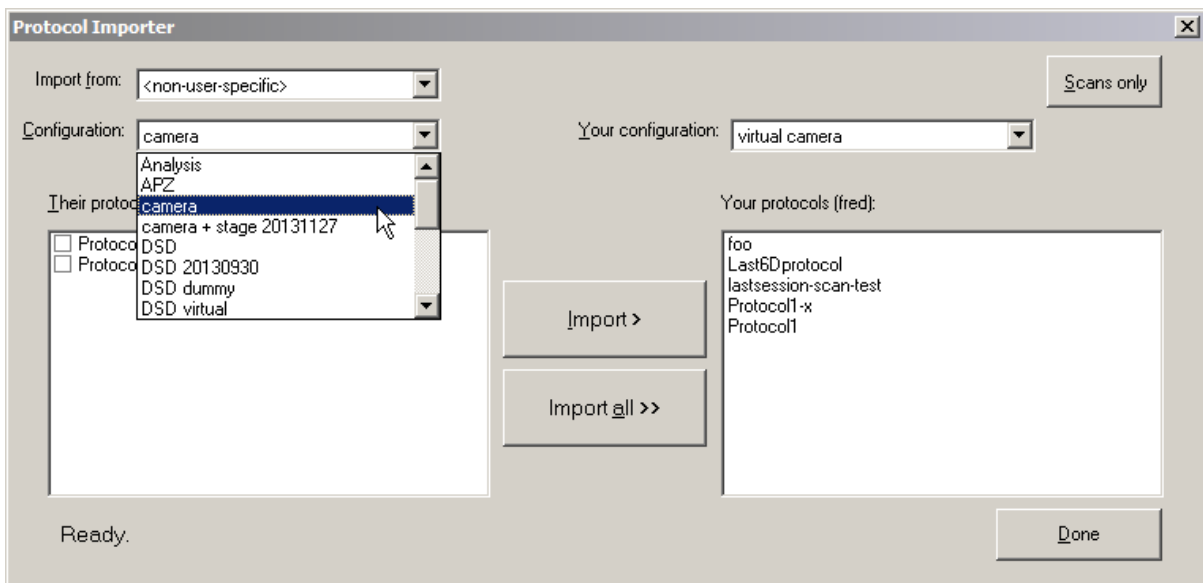

Tick the box beside each protocol you want to copy, then click "Import". In this example only "Protocol1" will be imported. You can click "Import all" if you want to copy all protocols from the configuration (you don't need to tick any of the boxes in this case).

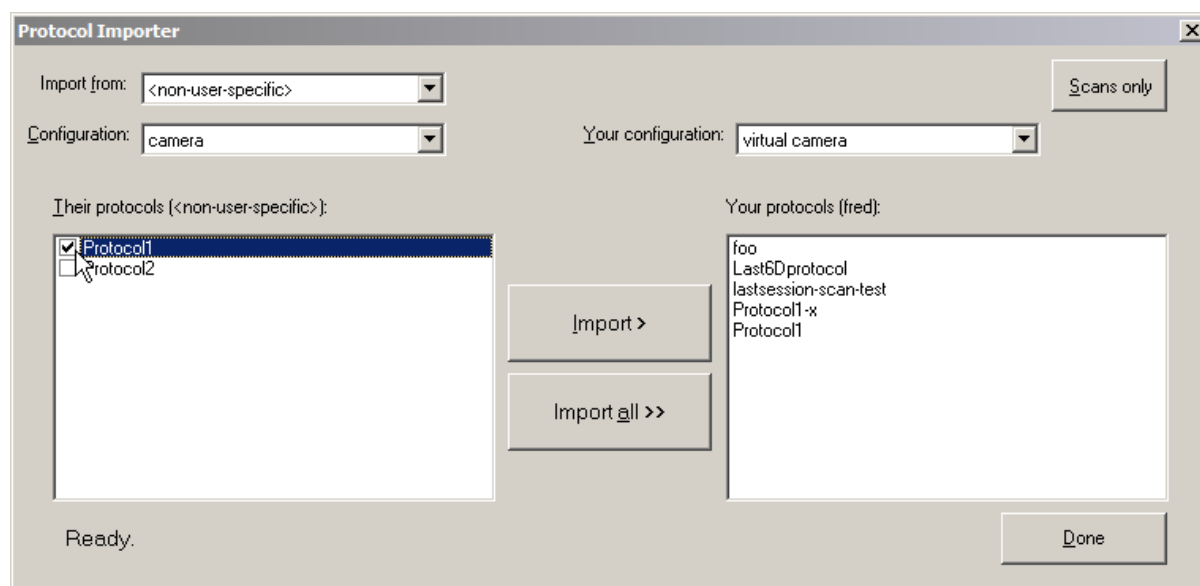

The protocols should have now been imported and are ready for use.

Name Conflicts

If a protocol you are importing has the same name as one already in your own configuration, then you will be prompted to rename the protocol being copied, as shown below.

For example, in the demonstration above the user "fred" tried to import "Protocol1" into his configuration which already contains a protocol by that name. The Protocol Importer therefore asks us what to do; we type the new name "Protocol1-fred" and click "Rename".

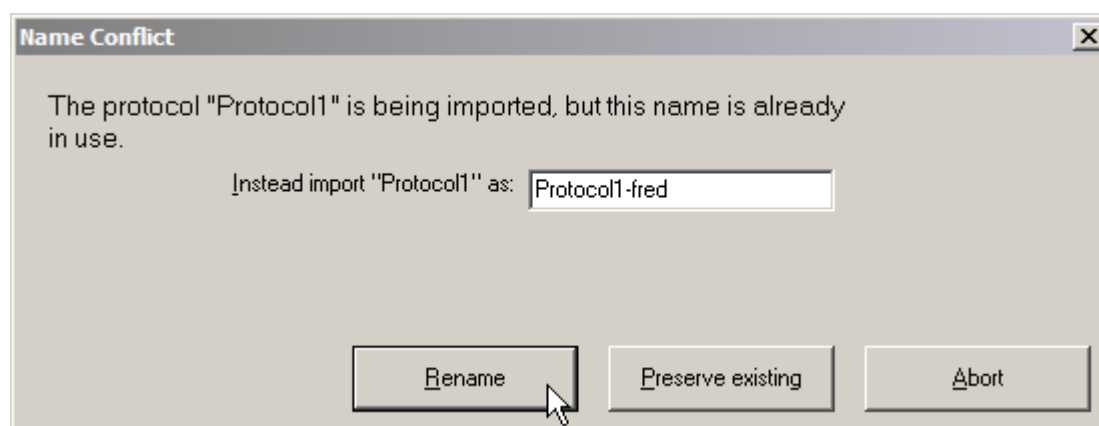

If, instead of choosing a new name, you want to skip importing this protocol and just keep the existing "Protocol1", click the "Preserve Existing" button instead. Any other

protocols being imported in the current batch will still be copied. If you want to abort the import of *all* protocols you had selected, just click "Abort".

Copying XY scan files

If a protocol being imported refers to an XY scan, you will be prompted for a course of action. You can choose to import the scan, or you can instead alter the protocol to refer to an existing scan in your configuration.

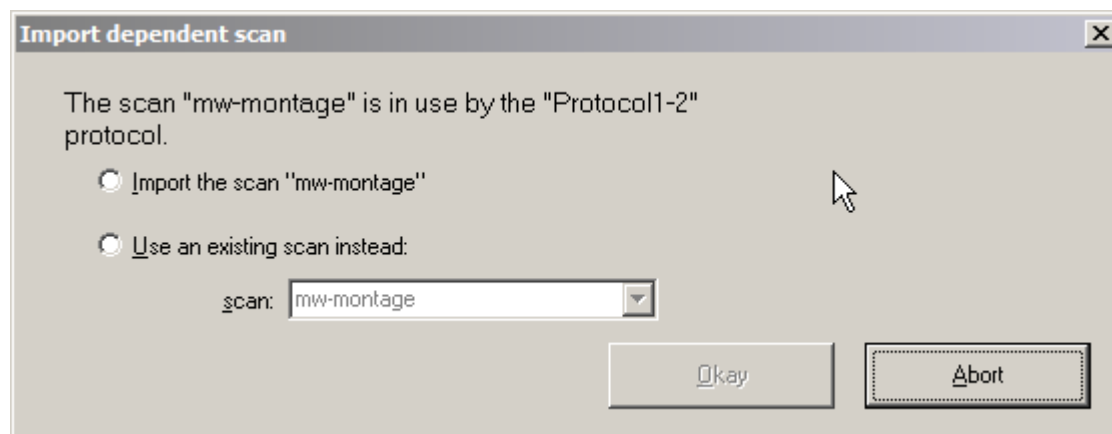

In the example above, we are importing a protocol that refers to the "mw-montage" scan. However we already copied over that scan with an earlier import, so we can select "Use an existing scan instead" and the newly-imported protocol can just refer to our existing copy.

XY Scan Import

You can import XY scans directly from another user, without having to import any scans. Press the "Scans only" button in the top-right corner. The importer window will now look like the below:

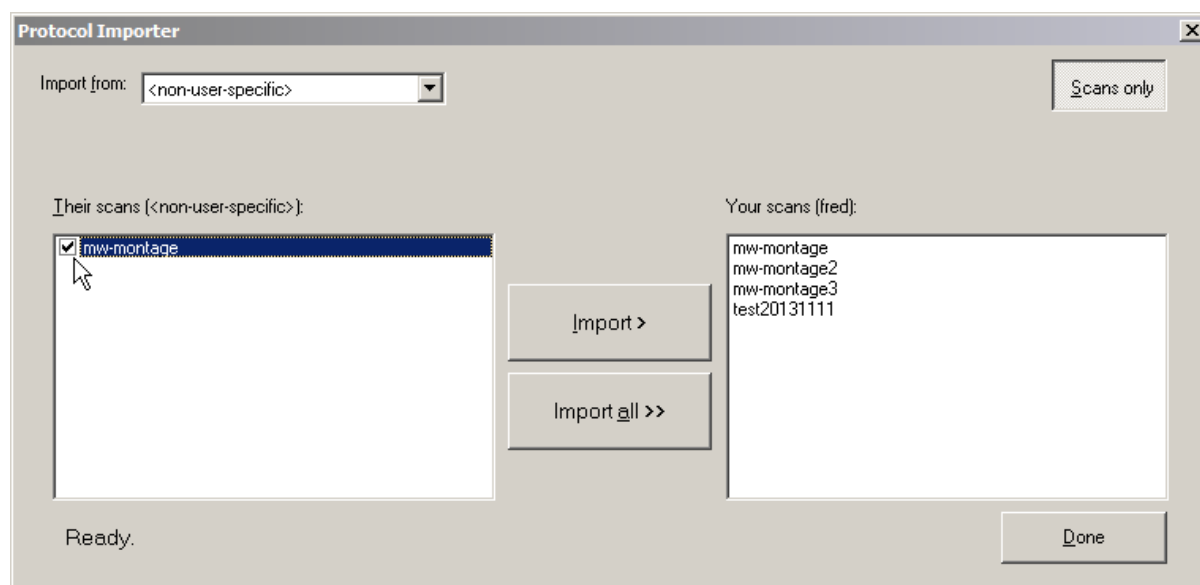

Andor iQ How To Documents

Since XY scans are independent of your choice of configuration, there is no need to select a configuration. Just tick the box beside each scan you want to copy over, then click "Import". As with importing protocols, if a scan of the given name already exists in the destination, you will be asked if you wish to rename it.

