

LIGHT MICROSCOPY



WHAT IS AN IMAGE???



1. A reproduction of the form of a person or object, especially a sculptured likeness.

2. An optically formed duplicate, counterpart, or other representative reproduction of an object, especially an optical reproduction formed by a lens or mirror.



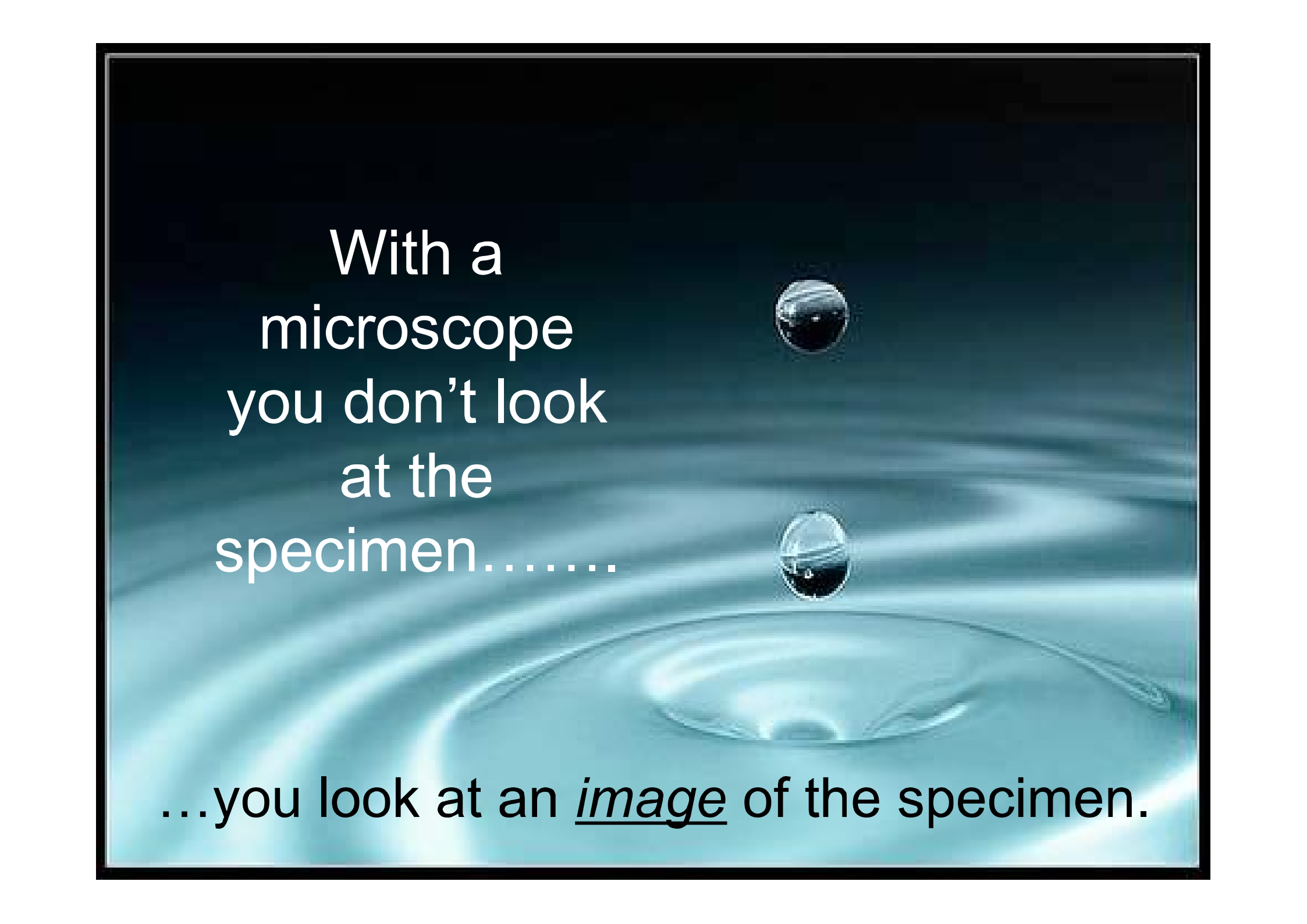

With a
microscope
you don't look
at the
specimen.....

...you look at an image of the specimen.

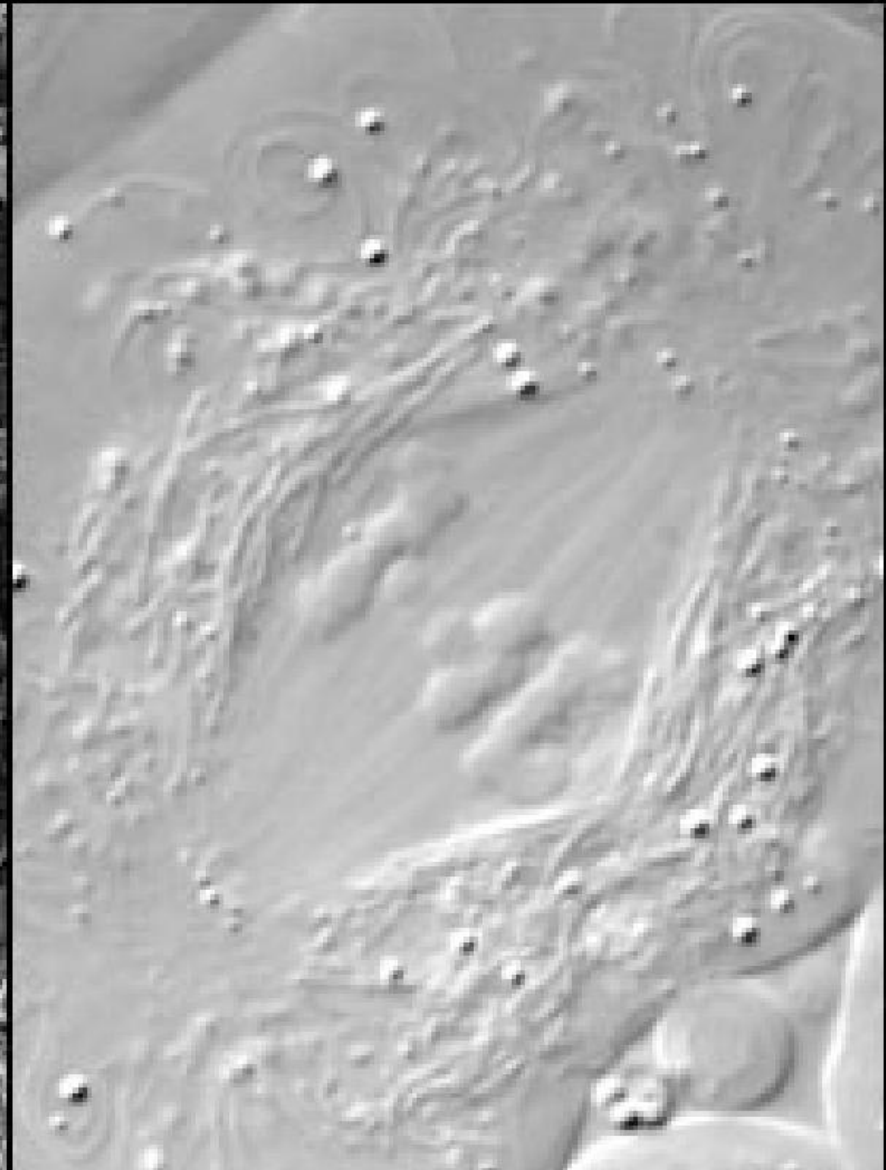
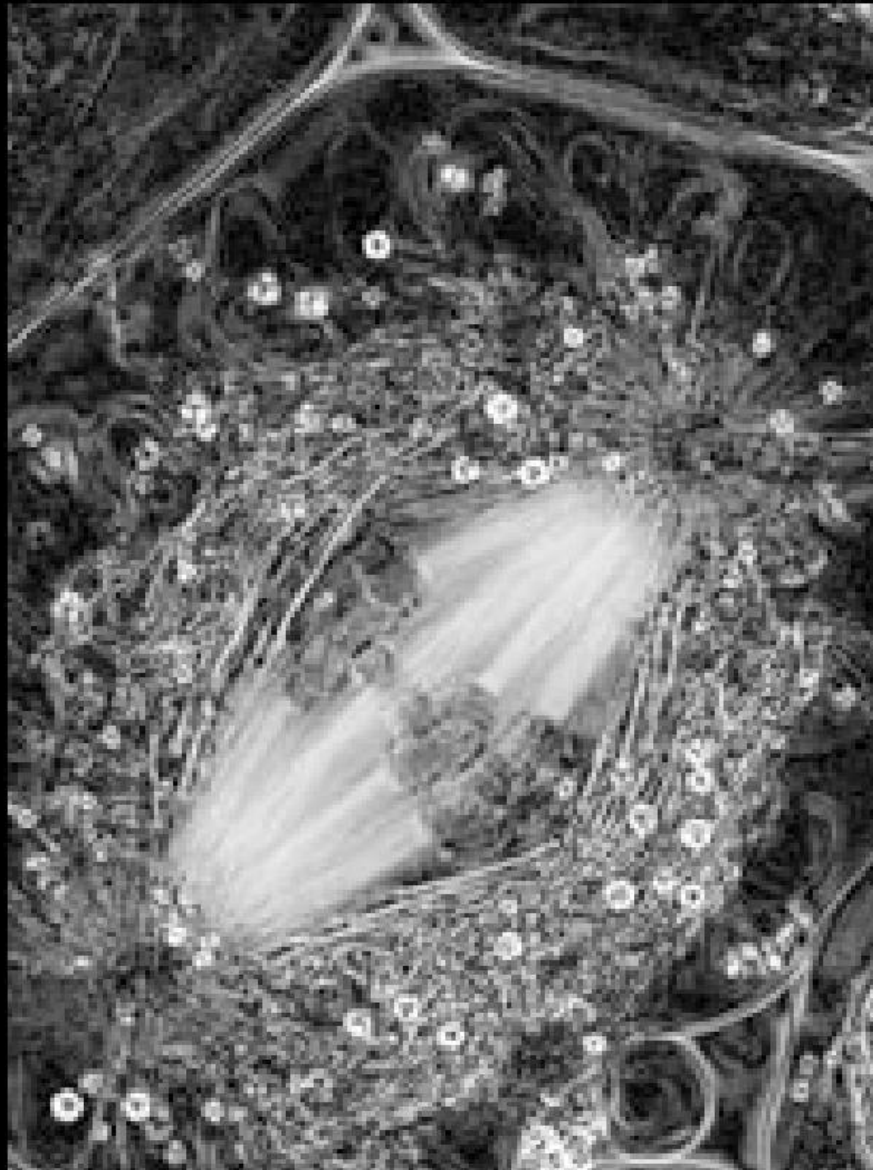

Brad Amos & Stefanie Reichelt



NO LIGHT.....

NO IMAGE....

NO MICROSCOPY!!!



Light rays carry information!!!!

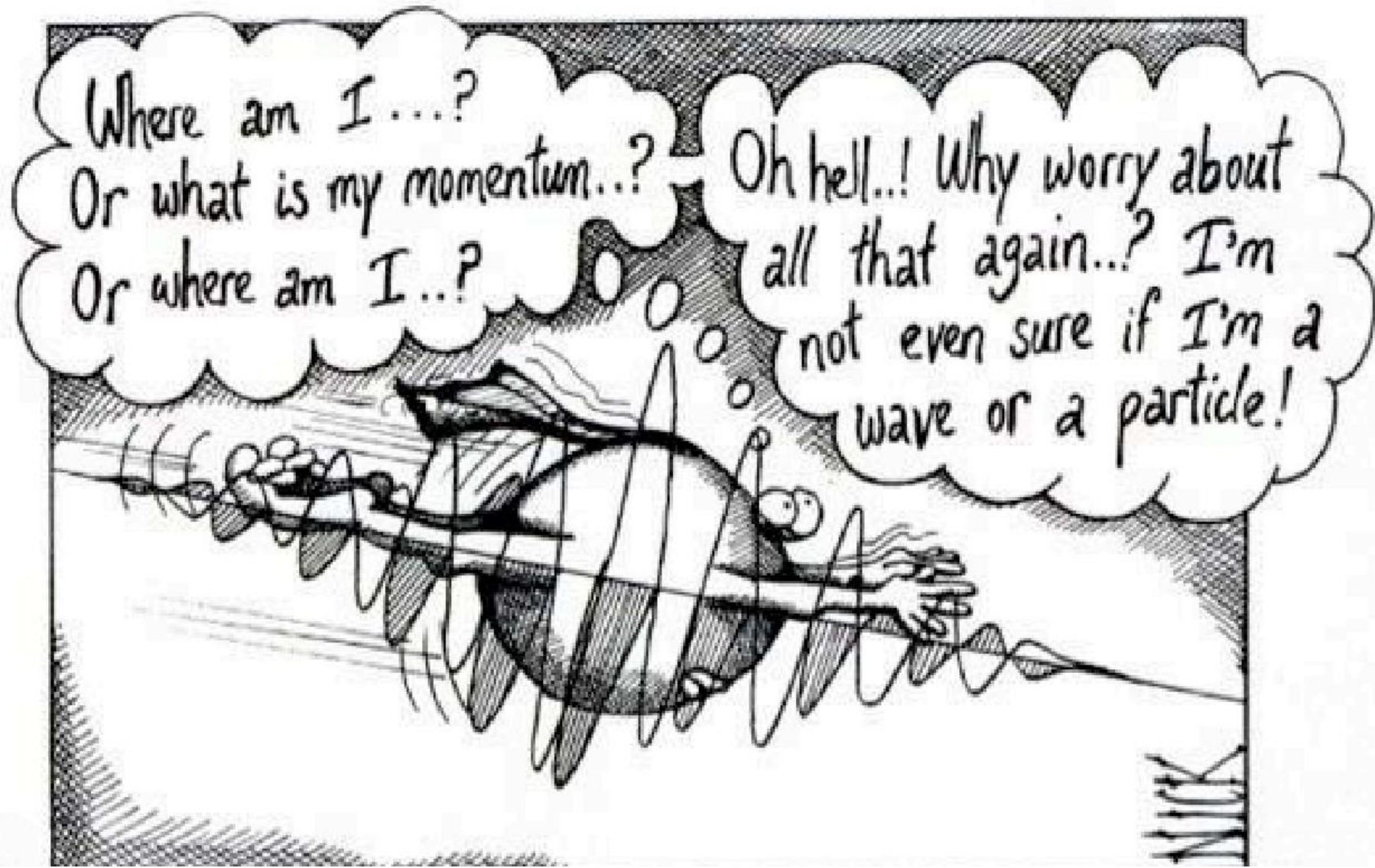

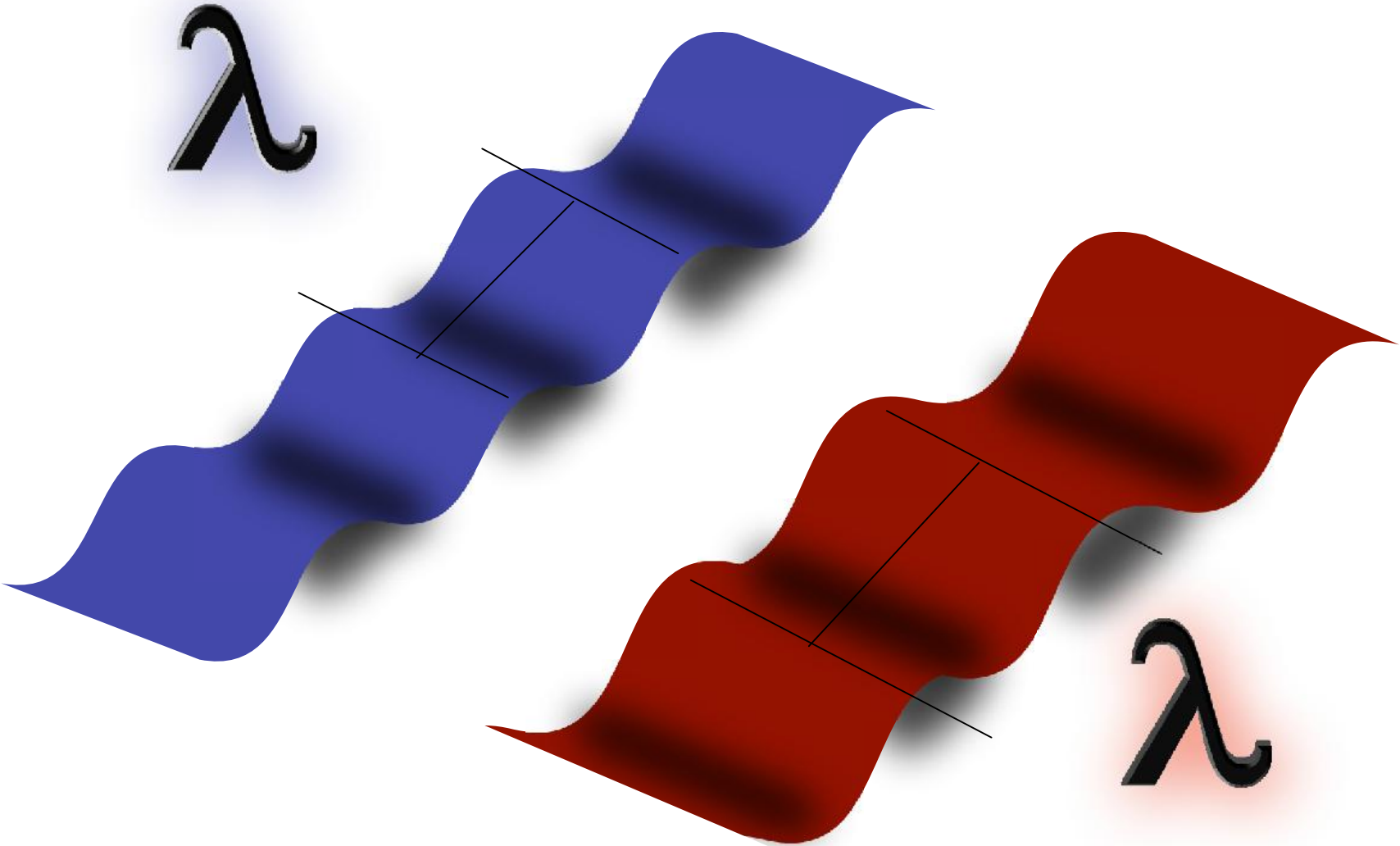

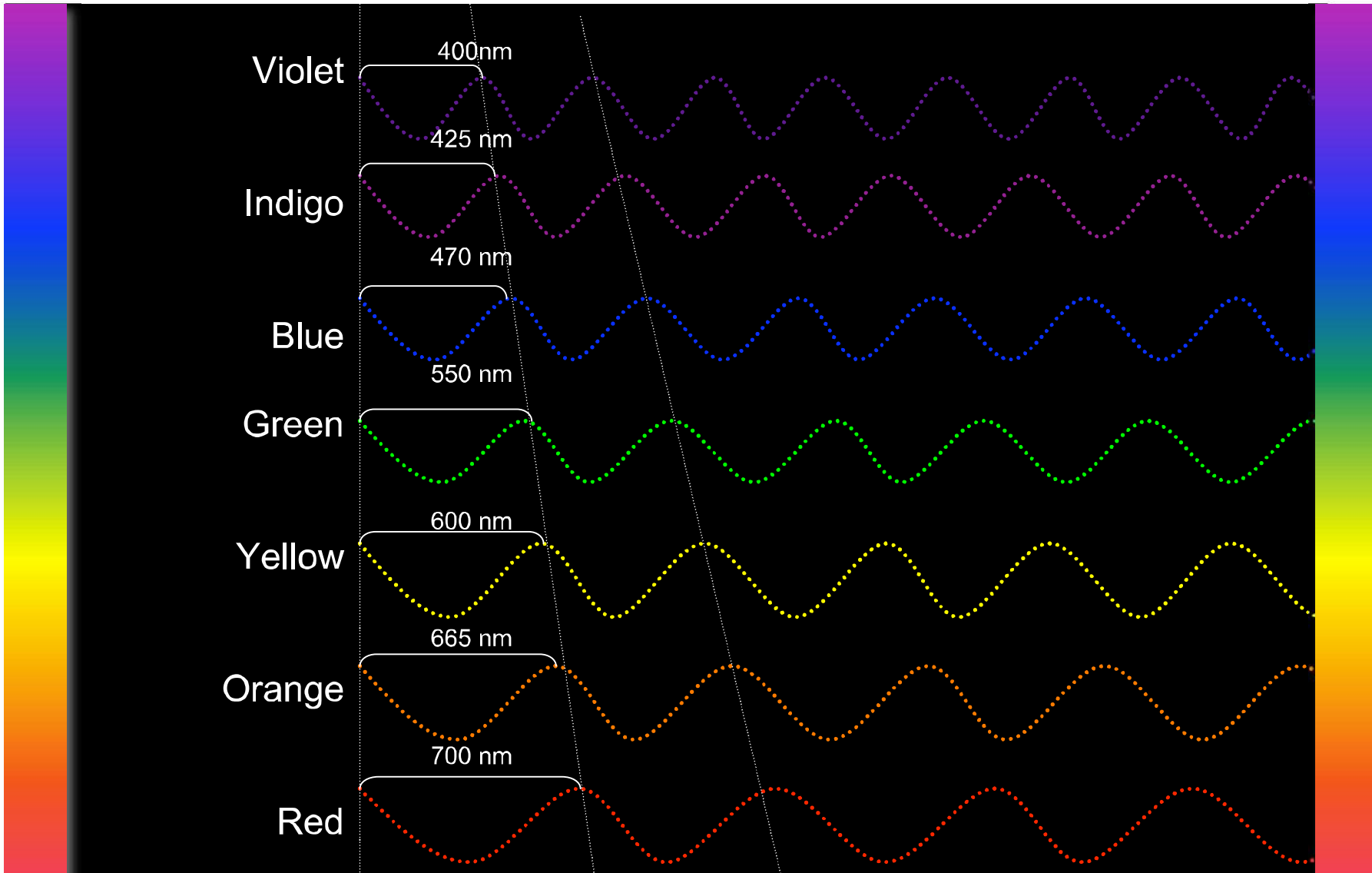

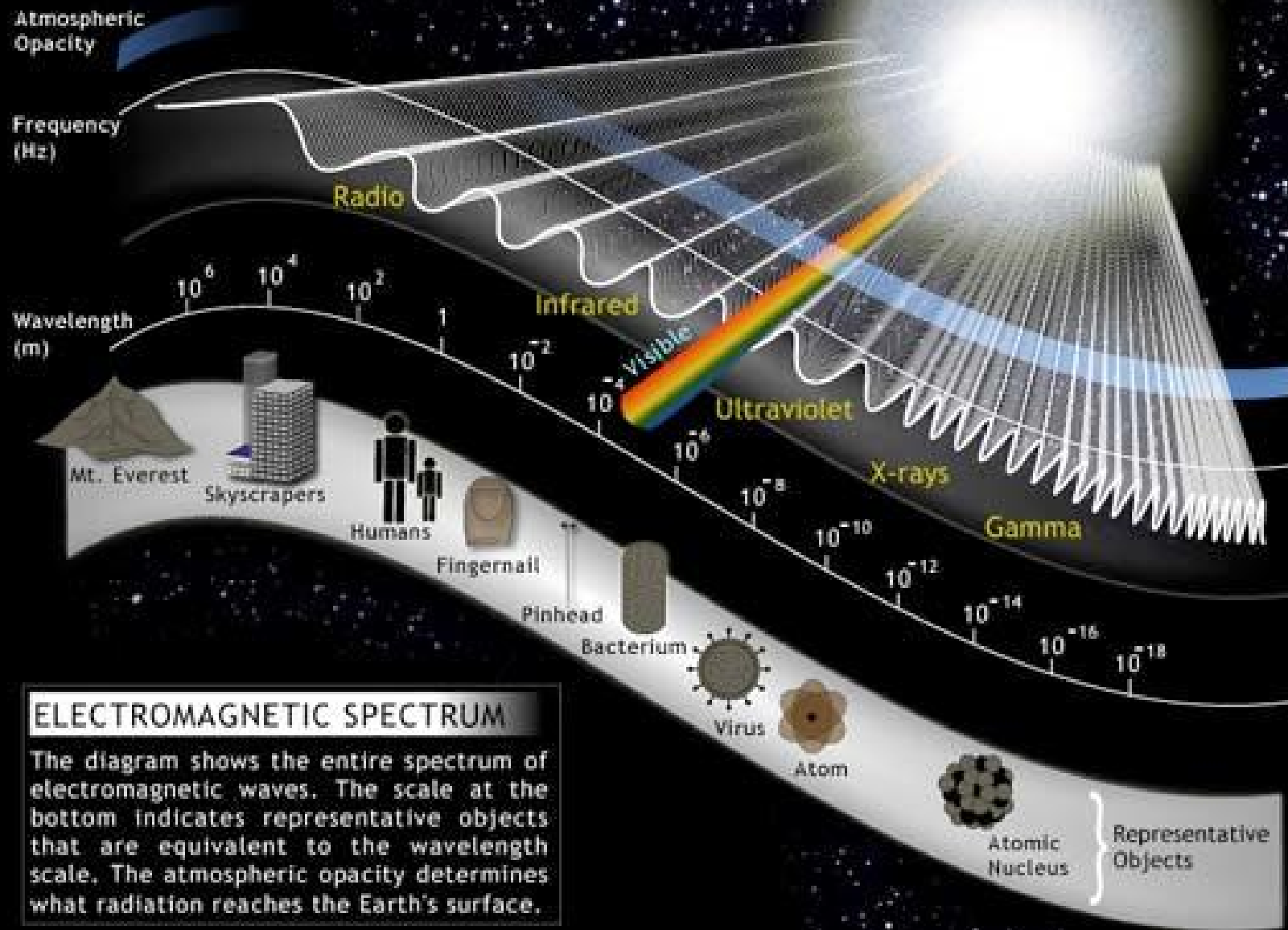

ELECTROMAGNETIC SPECTRUM
 The diagram shows the entire spectrum of electromagnetic waves. The scale at the bottom indicates representative objects that are equivalent to the wavelength scale. The atmospheric opacity determines what radiation reaches the Earth's surface.

Sources of Visible Light

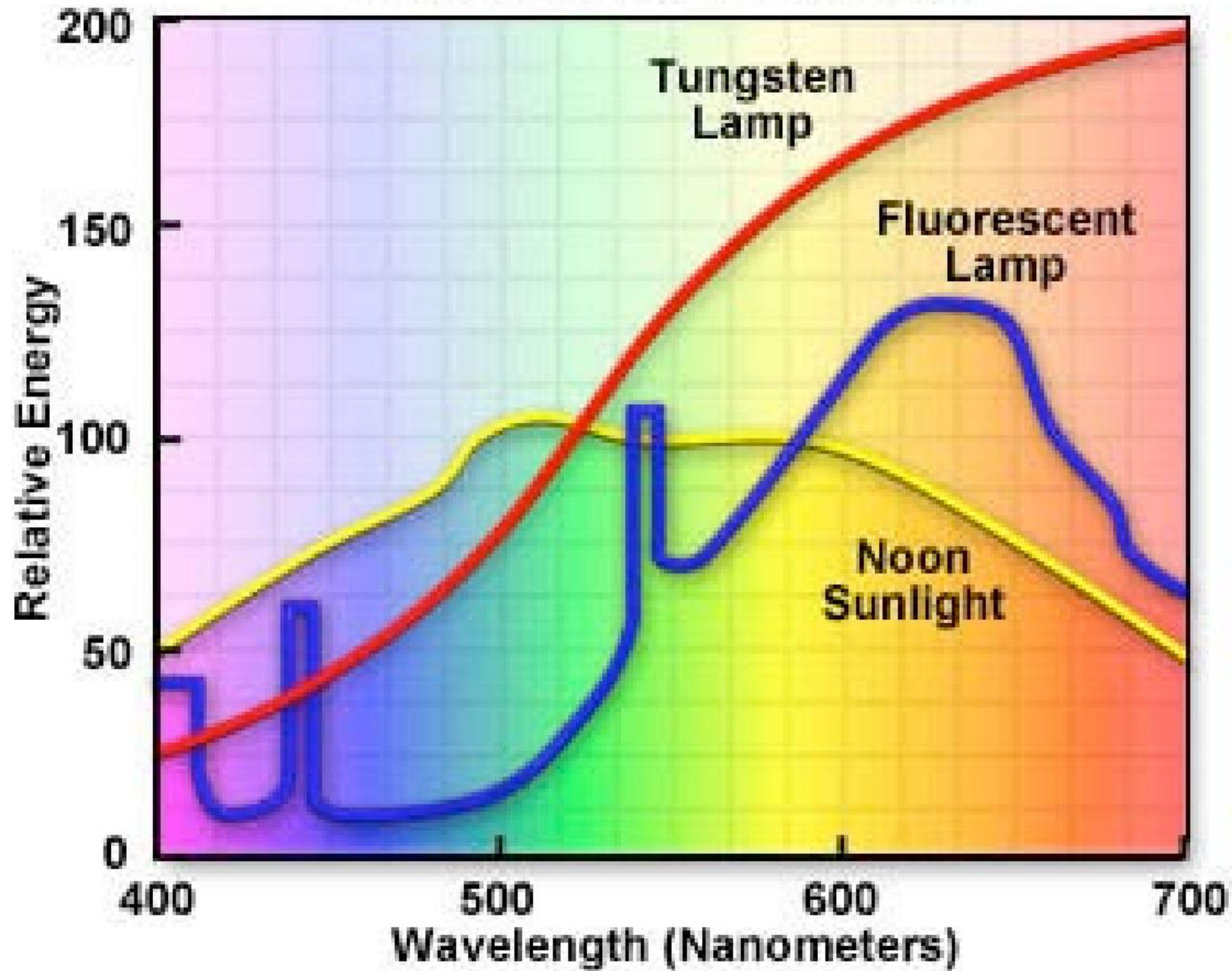

Daylight

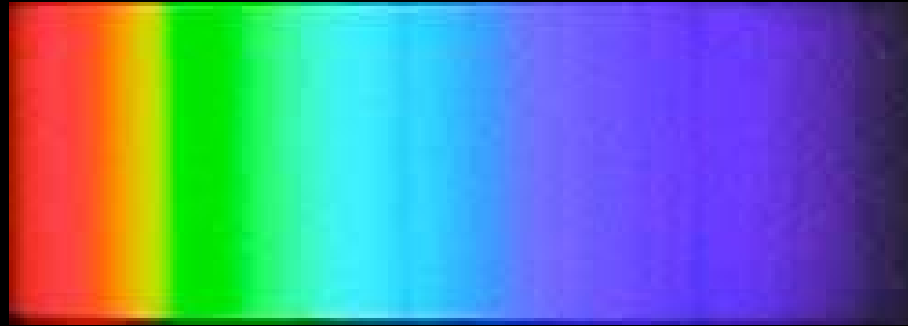

Incandescent lamp



Mercury lamp

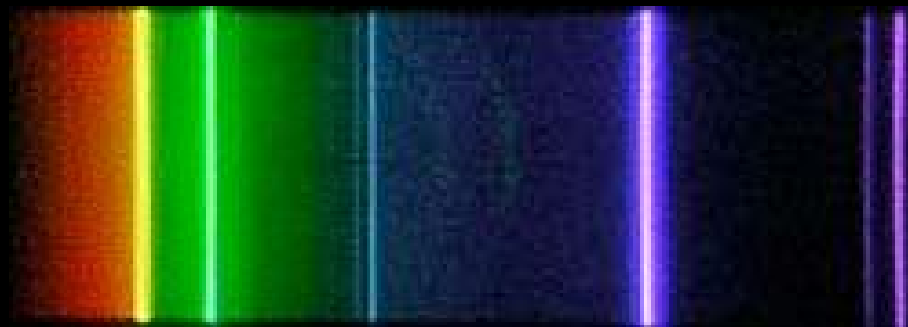

850

800

550

500

450

410

Spectrum of a Mercury Lamp

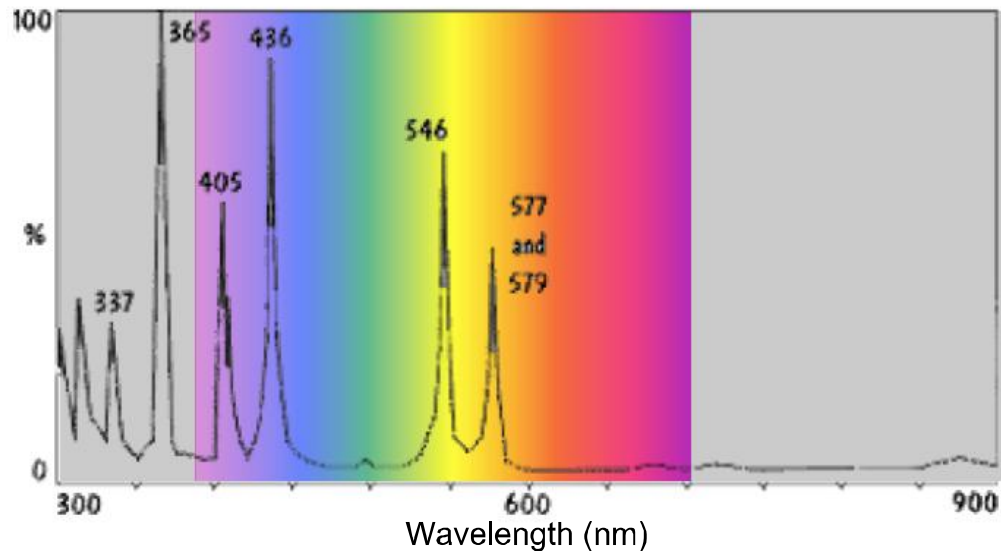

Spectrum of a Xenon Lamp

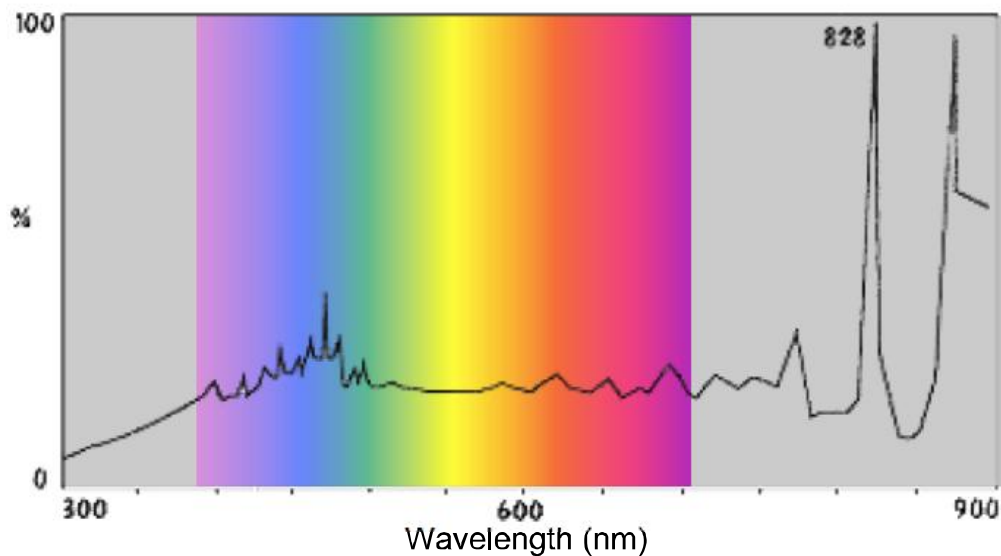

Light
sources
for
fluorescence

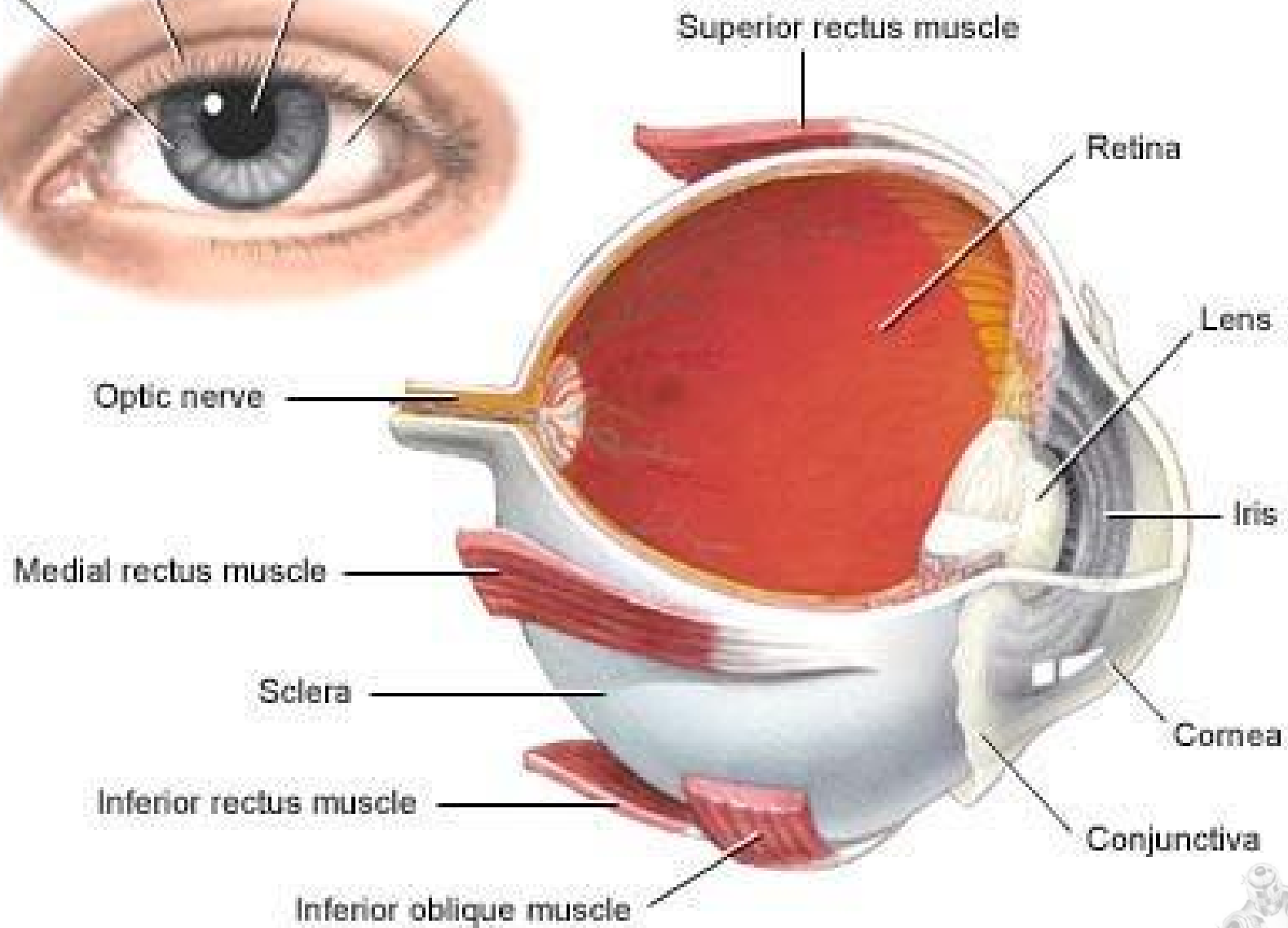
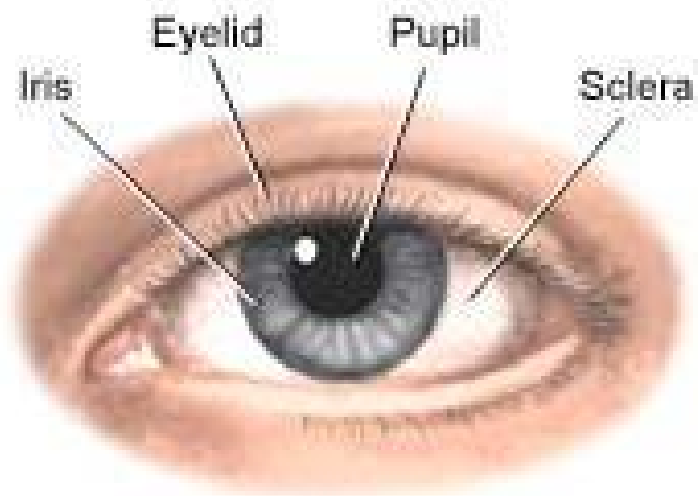

ONCE UPON A TIME.....



**Alhazen
(965-1040)**

(Ibn al-Haytham)

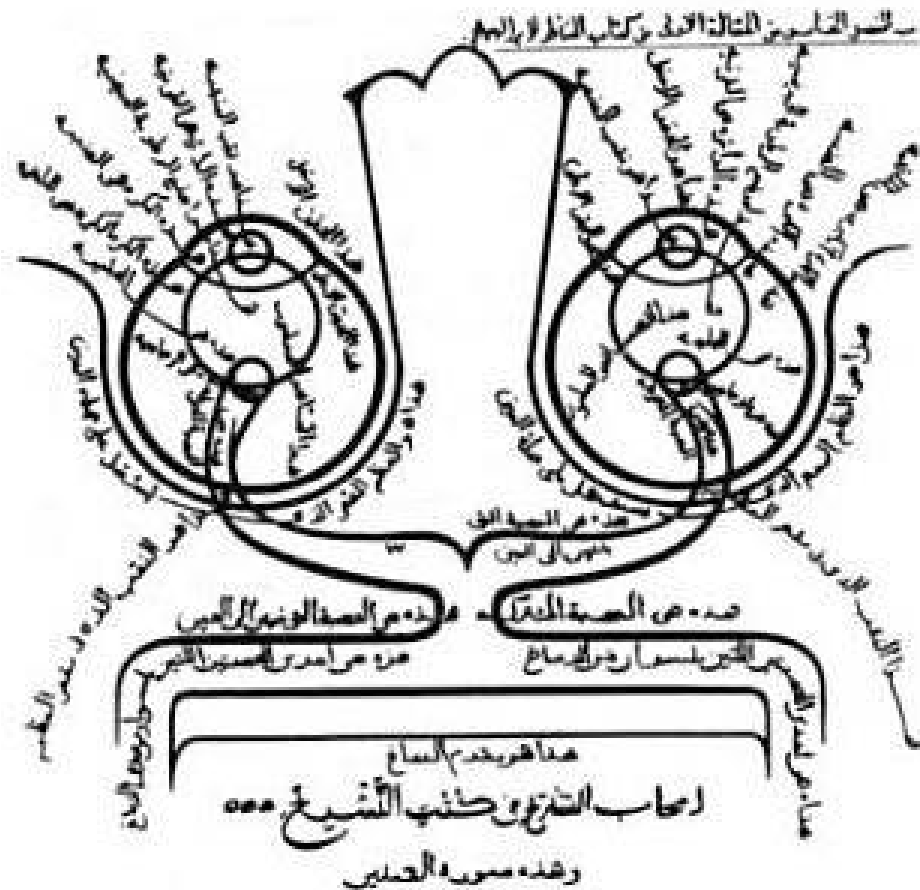

The eye, from **Al-Hazen's Opticae Thesaurus**—AD 1038.

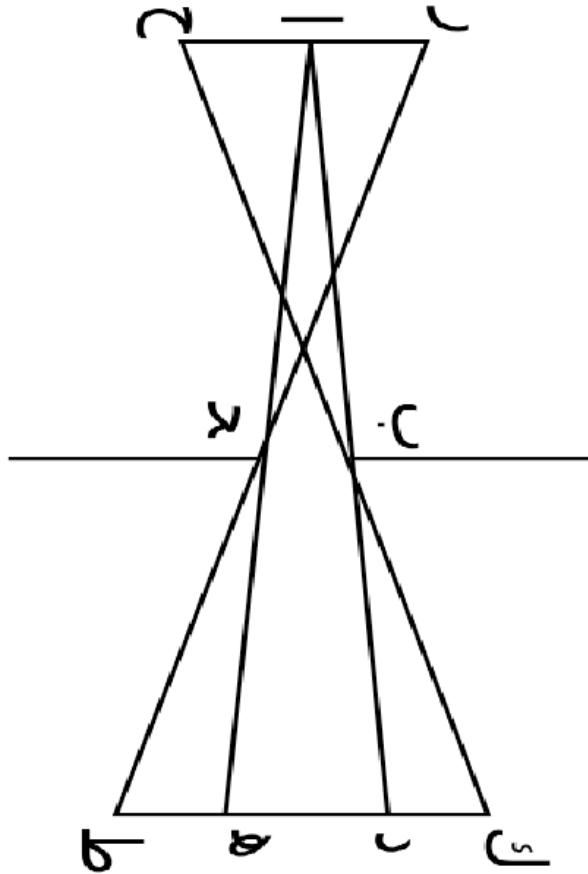

Alhazen was the first to show how the image is formed on the retina in the human eye, using the camera obscura as his model. However, as far as the camera obscura was concerned, he explained "Et nos non inventimus ita" we did not invent this.

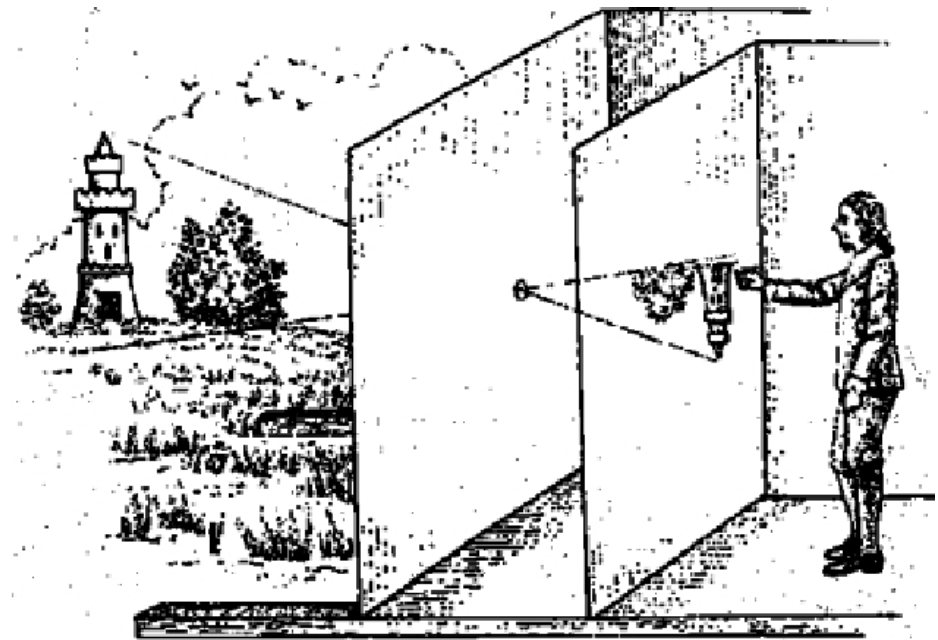

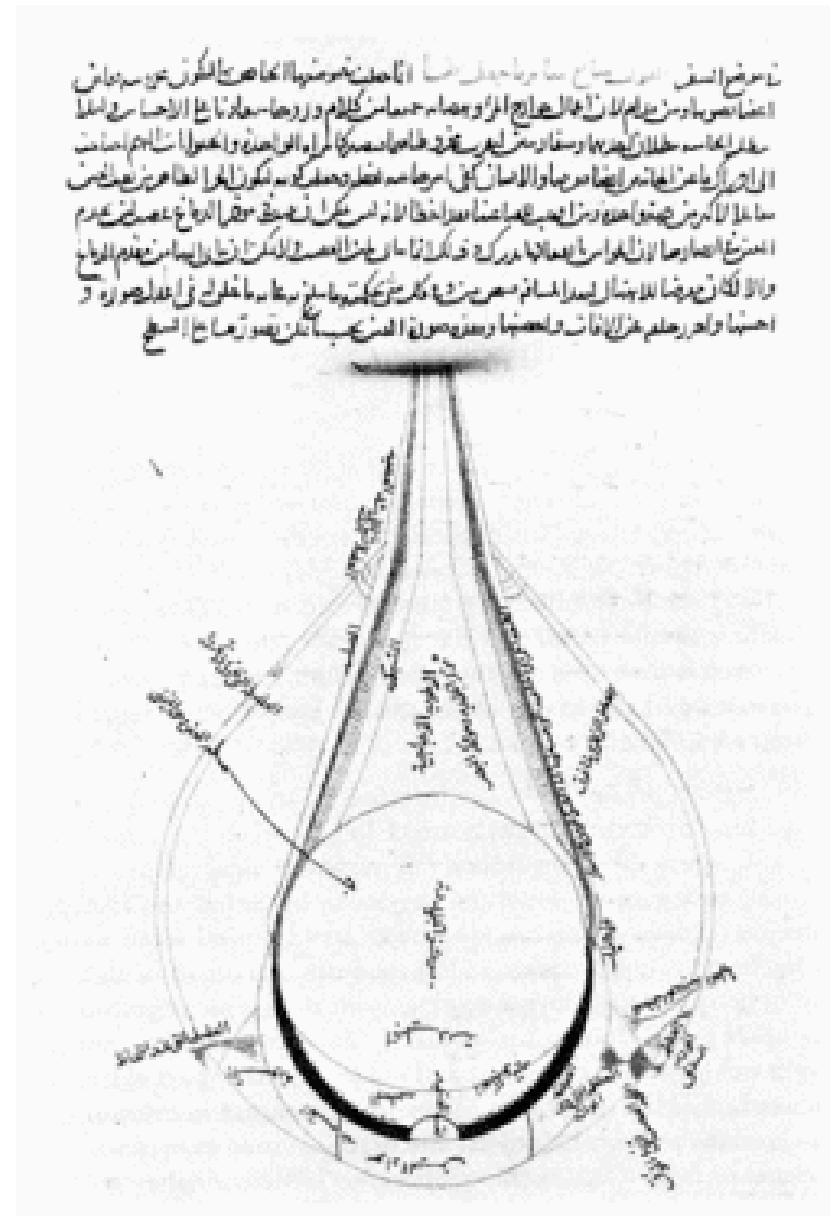
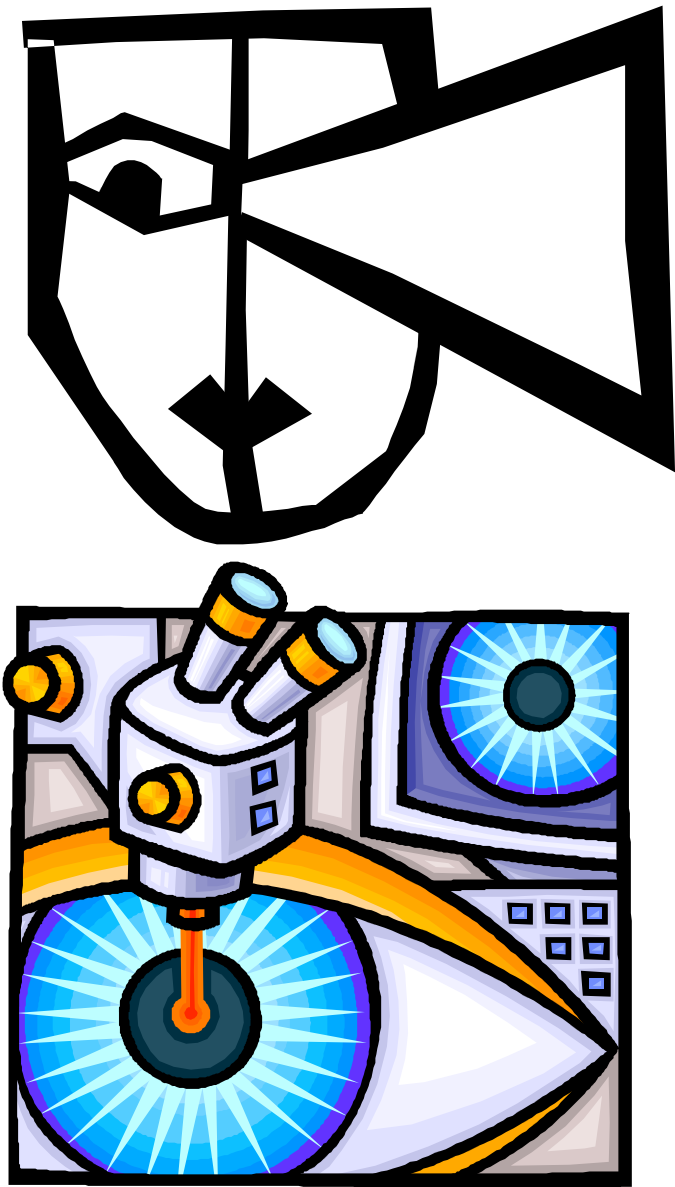

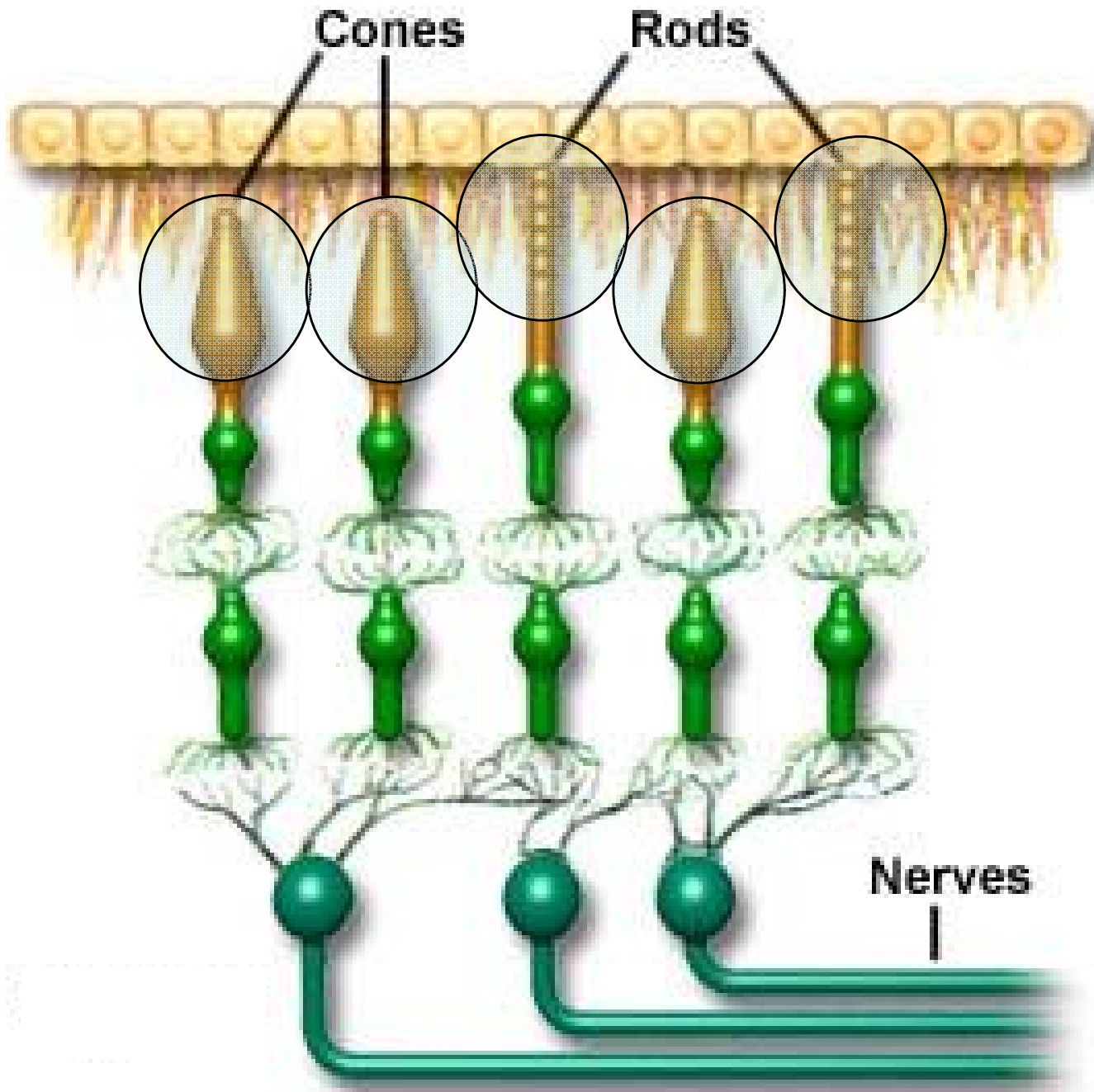

The relative intensity of the stimuli of each type of cones determines the color!!!!

430nm light
stimulate blue light
sensitive cones.
You see blue!

When the three
types of cones are
stimulated at the
same time....
With 550nm light
you see green

Your eyes see
ACHROMATIC
light...
WHITE LIGHT

At 630nm
you see red
light

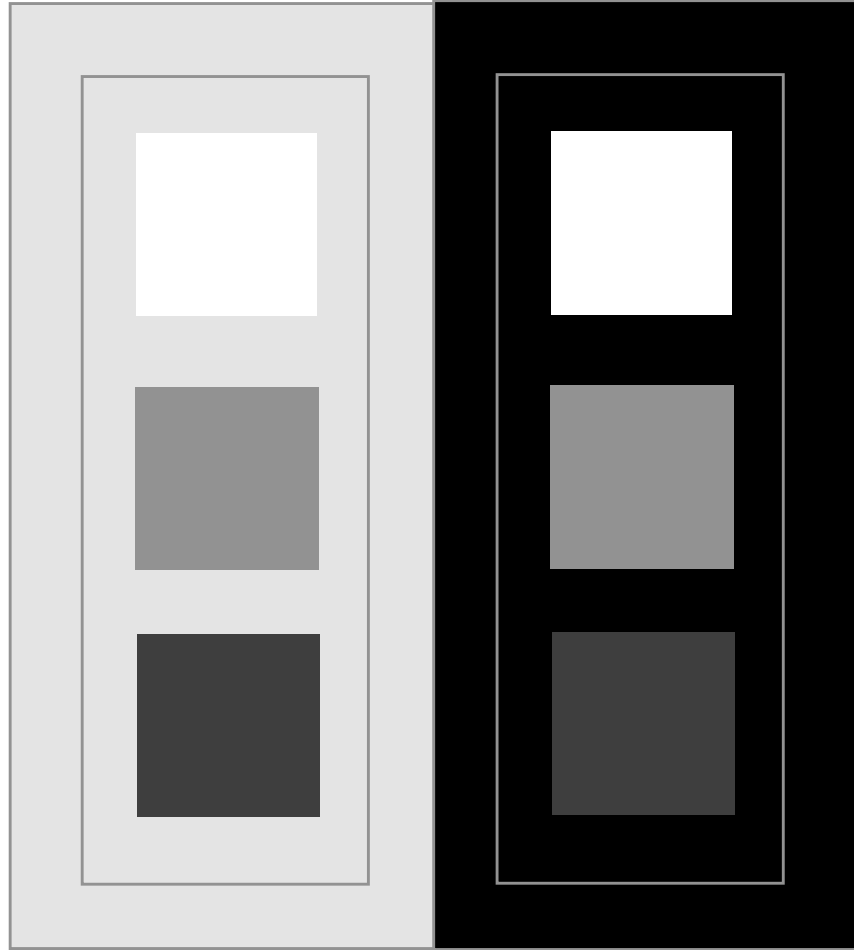

BASICS ON....

PROPERTIES OF LIGHT

• **Reflection**

• **Diffraction**

• **Refraction**

• **Absorption**

H O W L I G H T W A K E T H I N G S V I S I B L E



H O W L I G H T M A K E S T H I N G S V I S I B L E

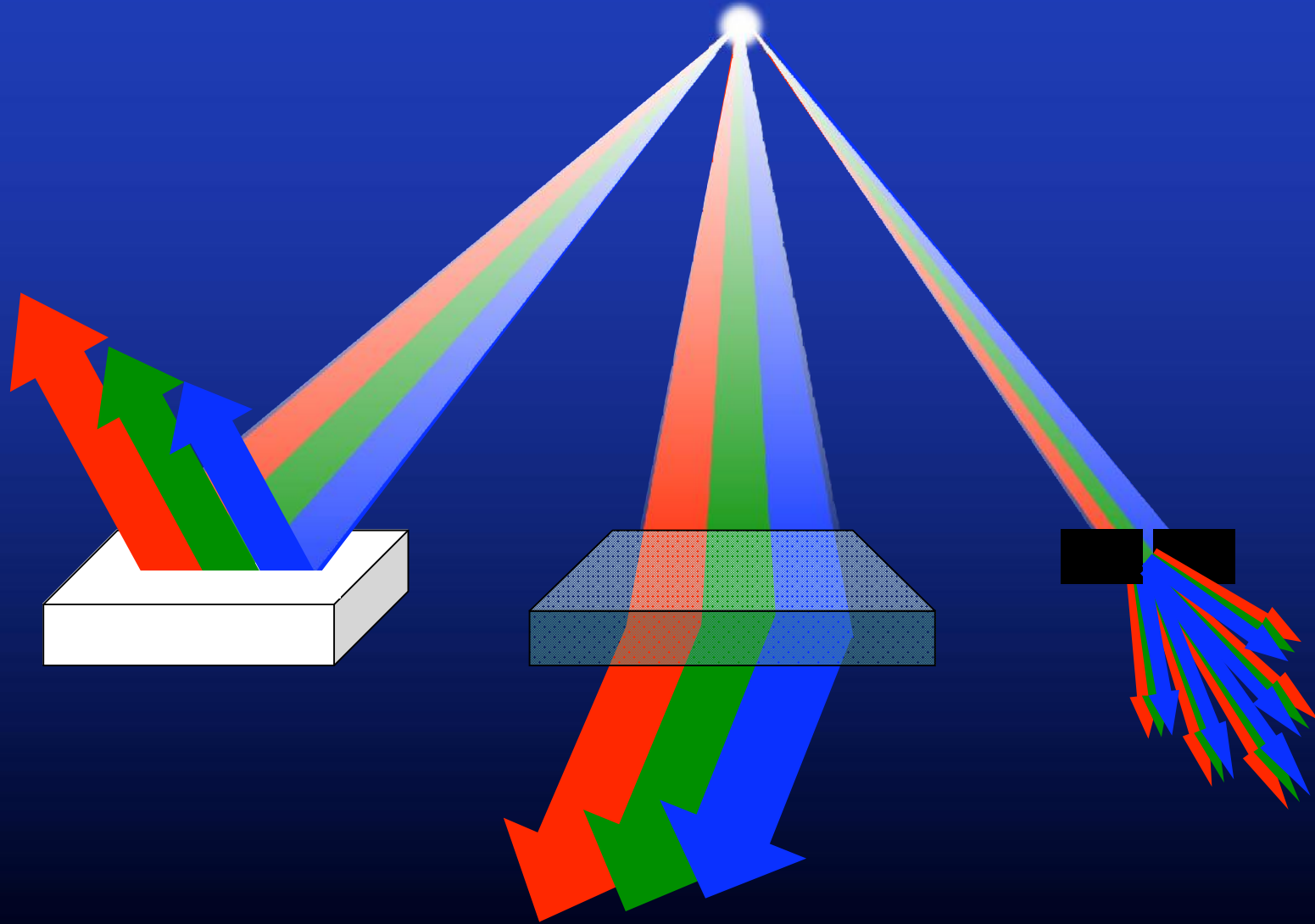



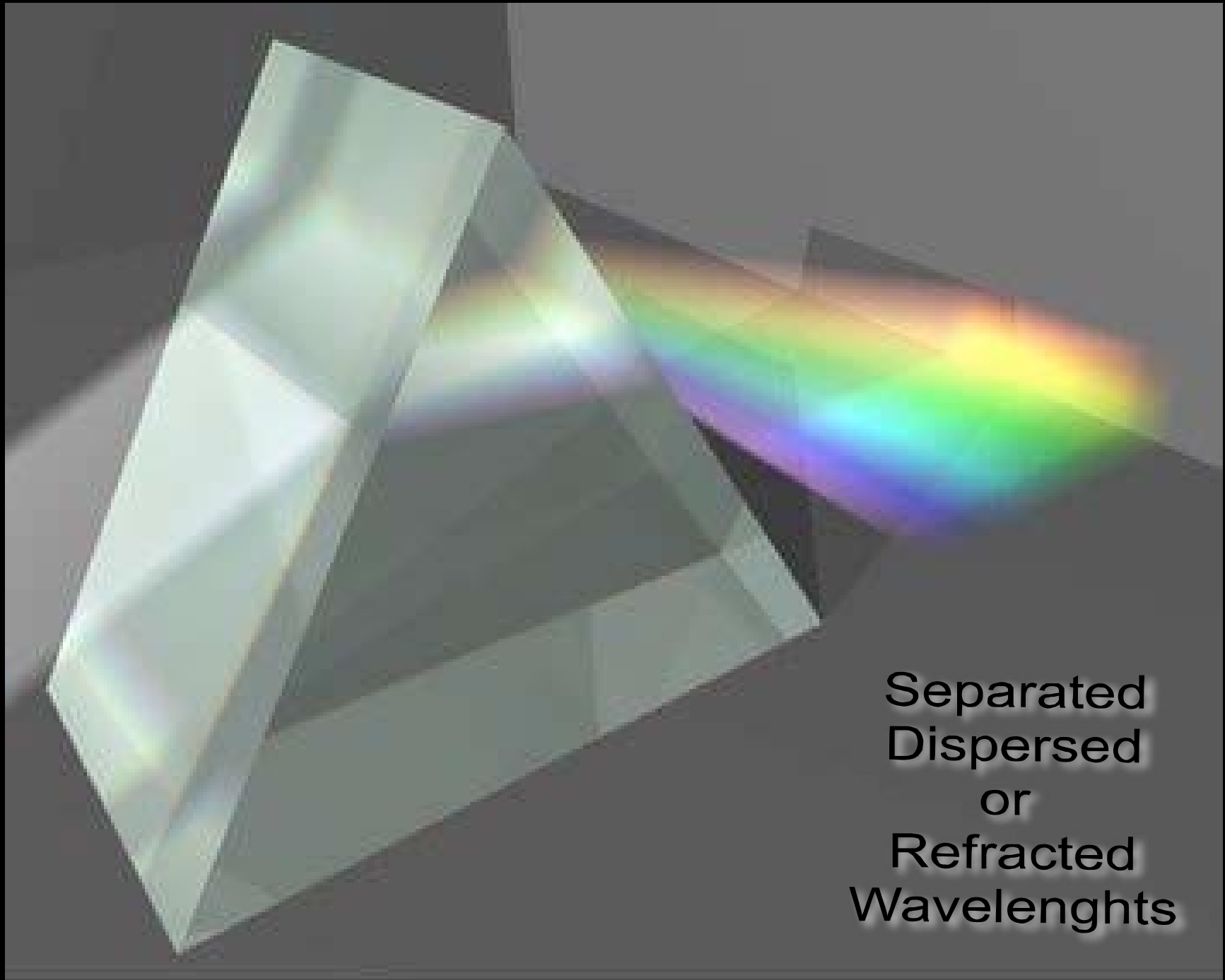

Separated
Dispersed
or
Refracted
Wavelengths

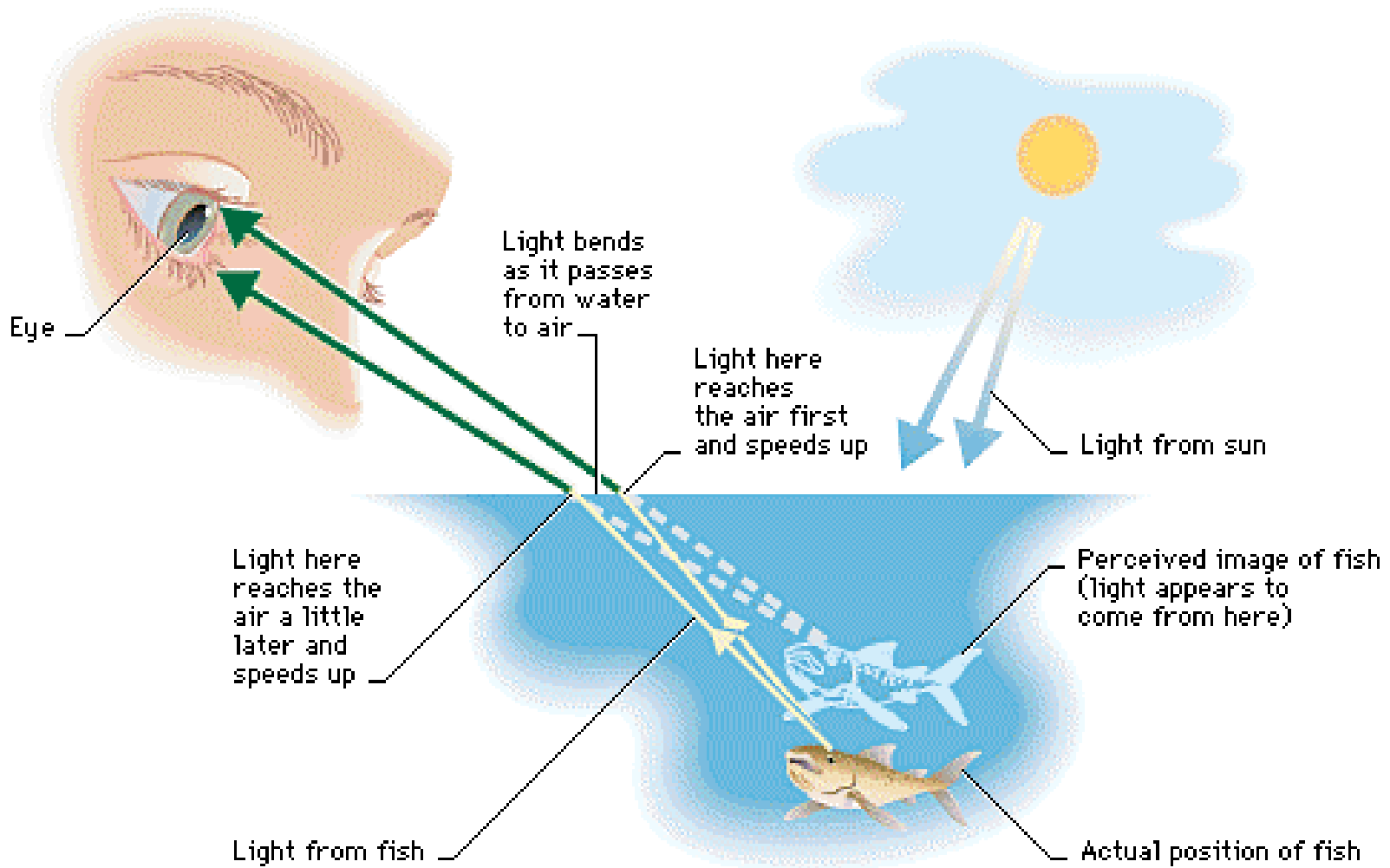

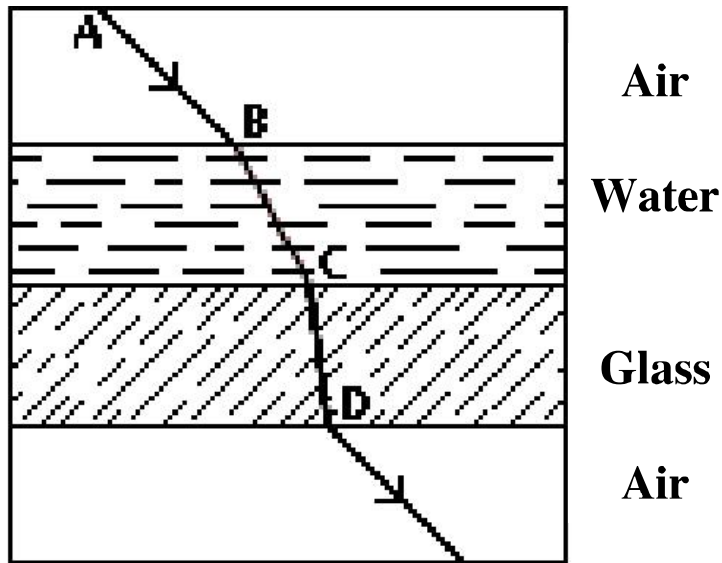

Refracted rays passing through three different media

Refraction of Light

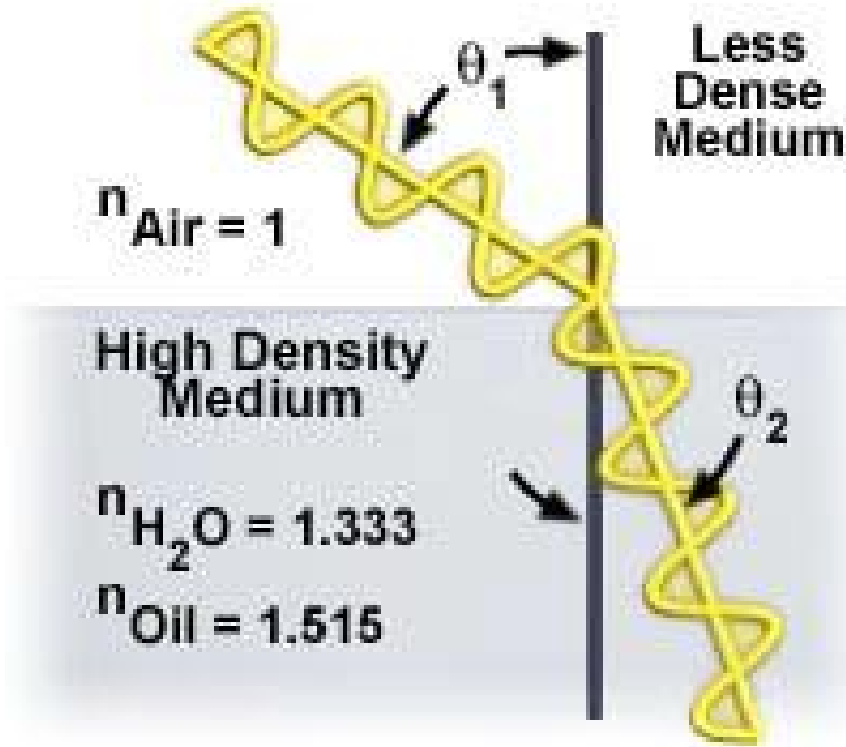

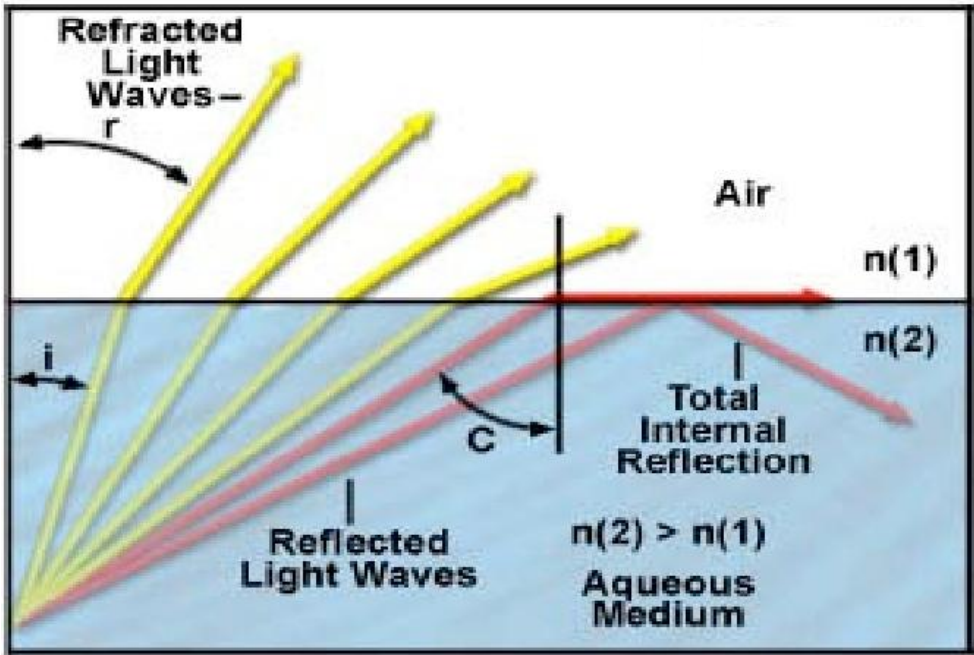





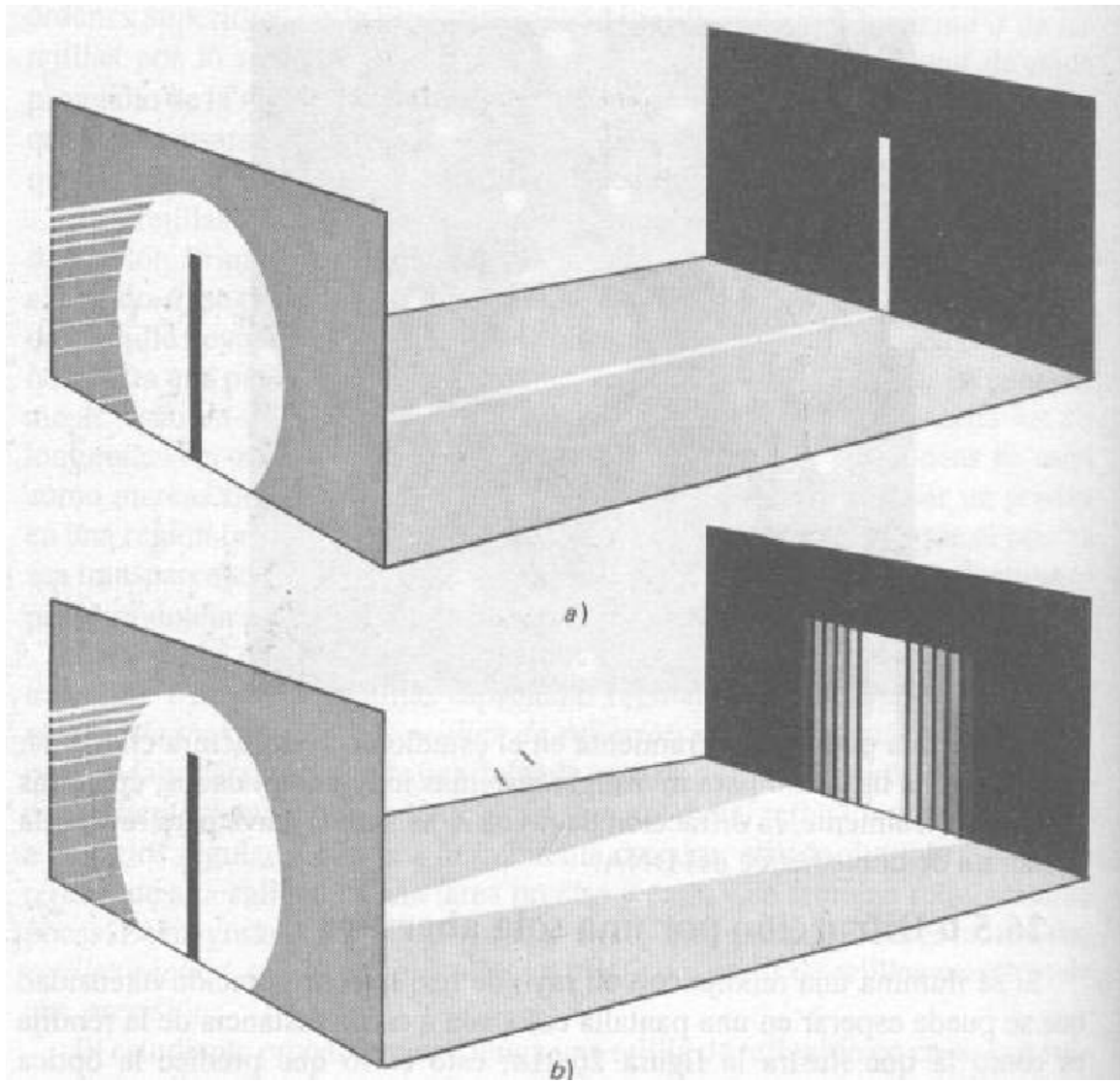

DIFRACTION



INTRODUCTION TO LENSES



13th Century
Reading stones



Early Microscope Attributed to Jansen
(about 1595)



XV Century. Leonardo Da Vinci ...
The necessity to use lenses to facilitate vision and too see small things....



XVII Century.
Zaccharias & Hans Jansen 1590
Galileo Galilei 1609
Christiaan Huygens 1621

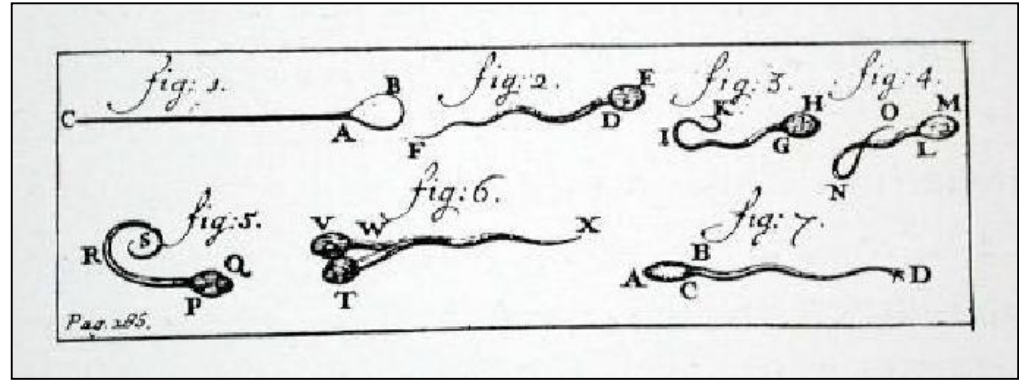

Human sperm

Antony van Leeuwenhoek 1632 - 1723

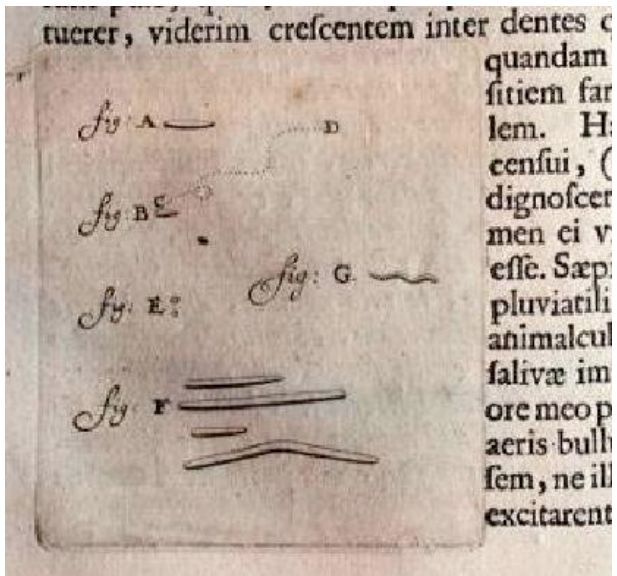

Bacteria







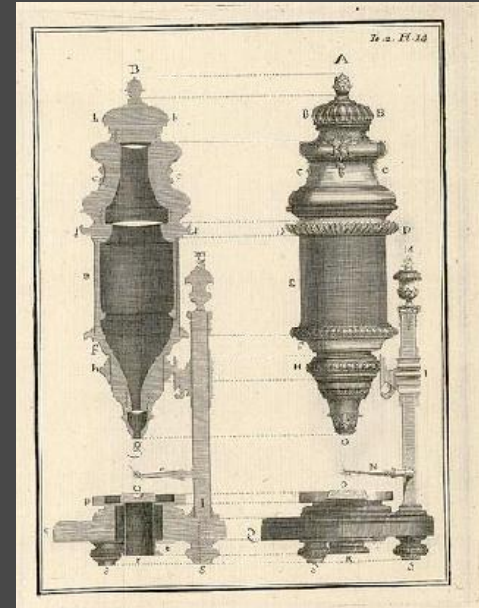
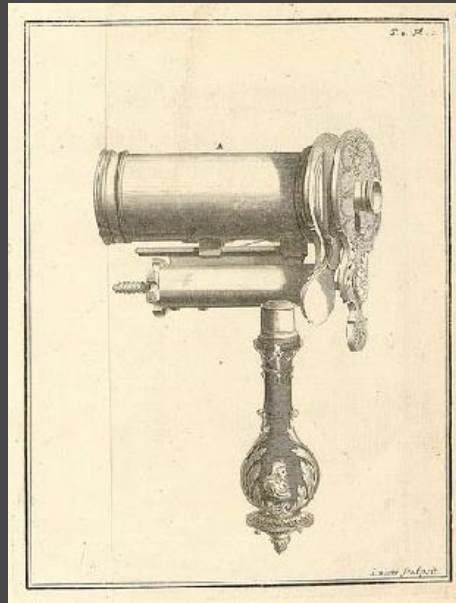
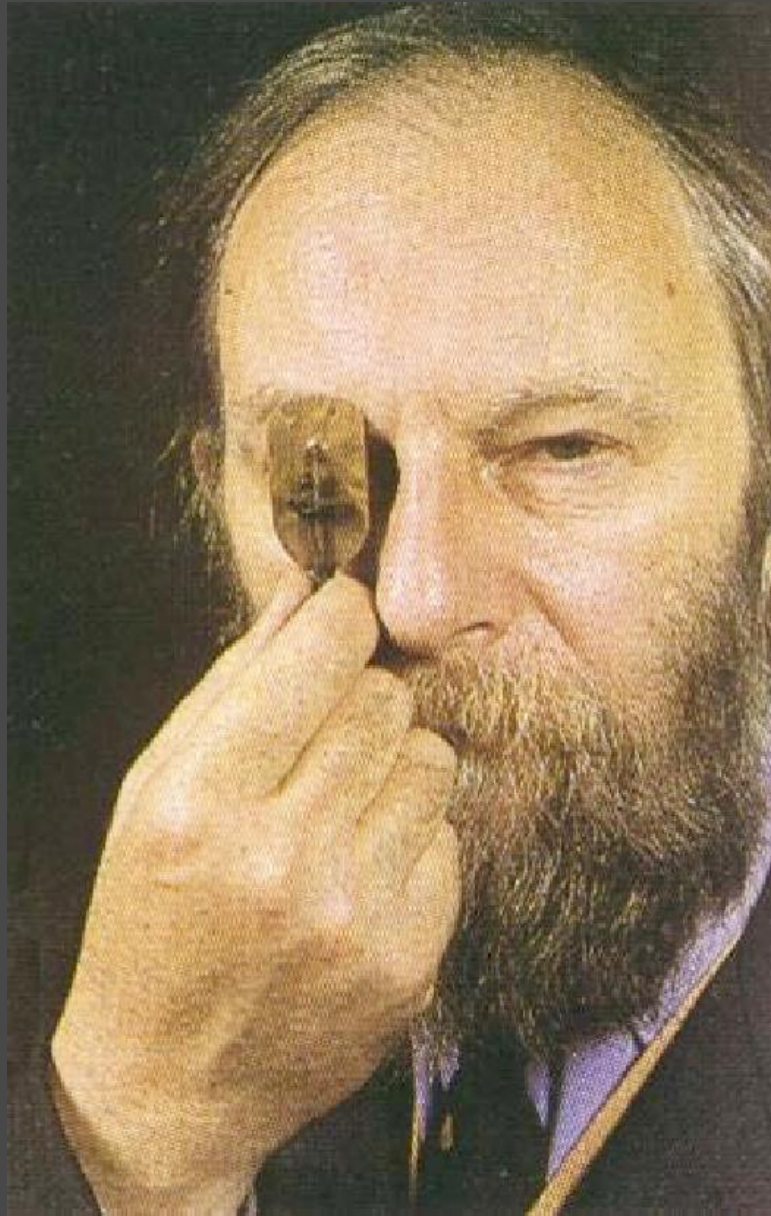

MICROGRAPHIA:

OR SOME

Physiological Descriptions

OF

MINUTE BODIES

MADE BY

MAGNIFYING GLASSES.

WITH

OBSERVATIONS and INQUIRIES thereupon.

By R. HOOKE, Fellow of the ROYAL SOCIETY.

*Non possis oculo quantum contendere Linceus,
Non tamen idcirco contemnas Lippus inungi. Horat. Ep. lib. 1.*



LONDON, Printed by *Jo. Martyn*, and *Jo. Allestry*, Printers to the
ROYAL SOCIETY, and are to be sold at their Shop at the *well* in
S. Paul's Church-yard. M DC LX V.

Fig: 1.

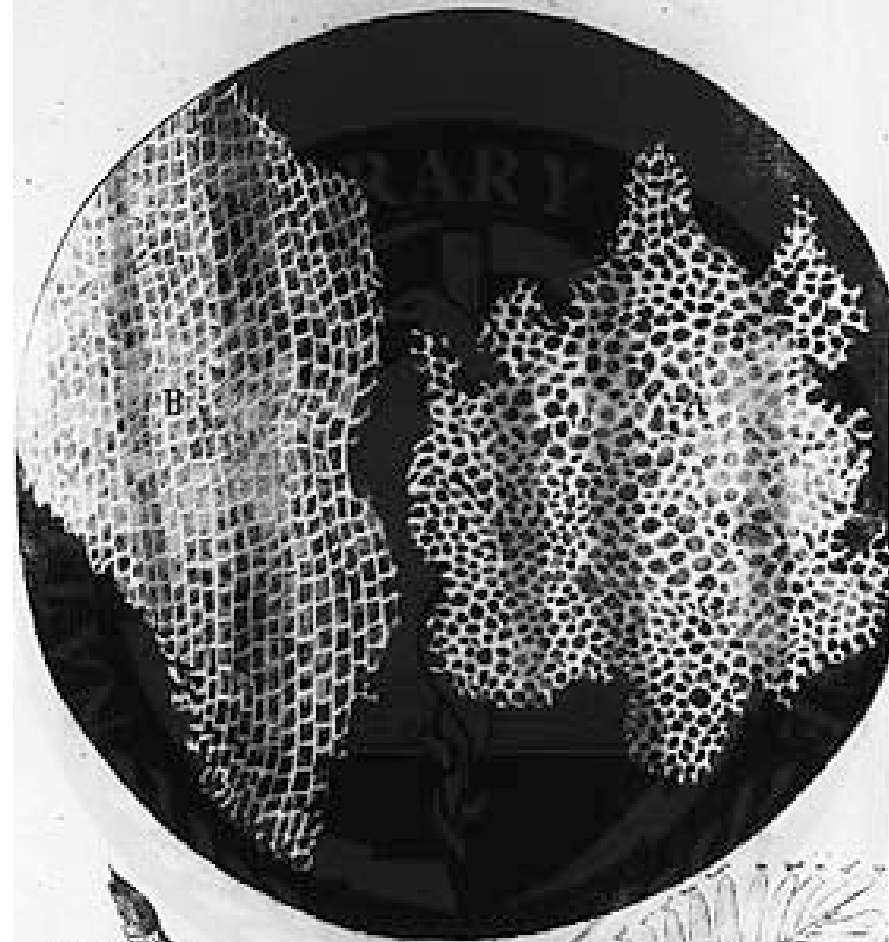
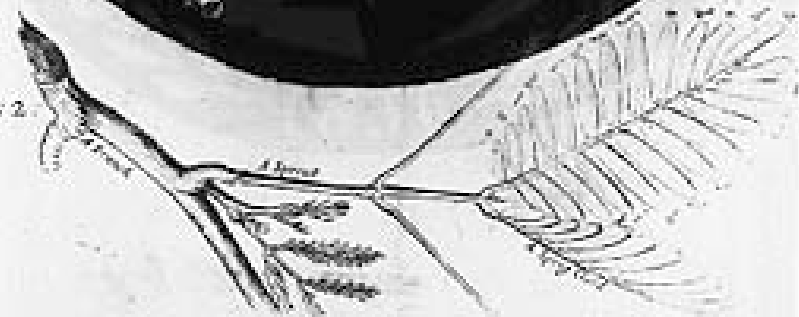
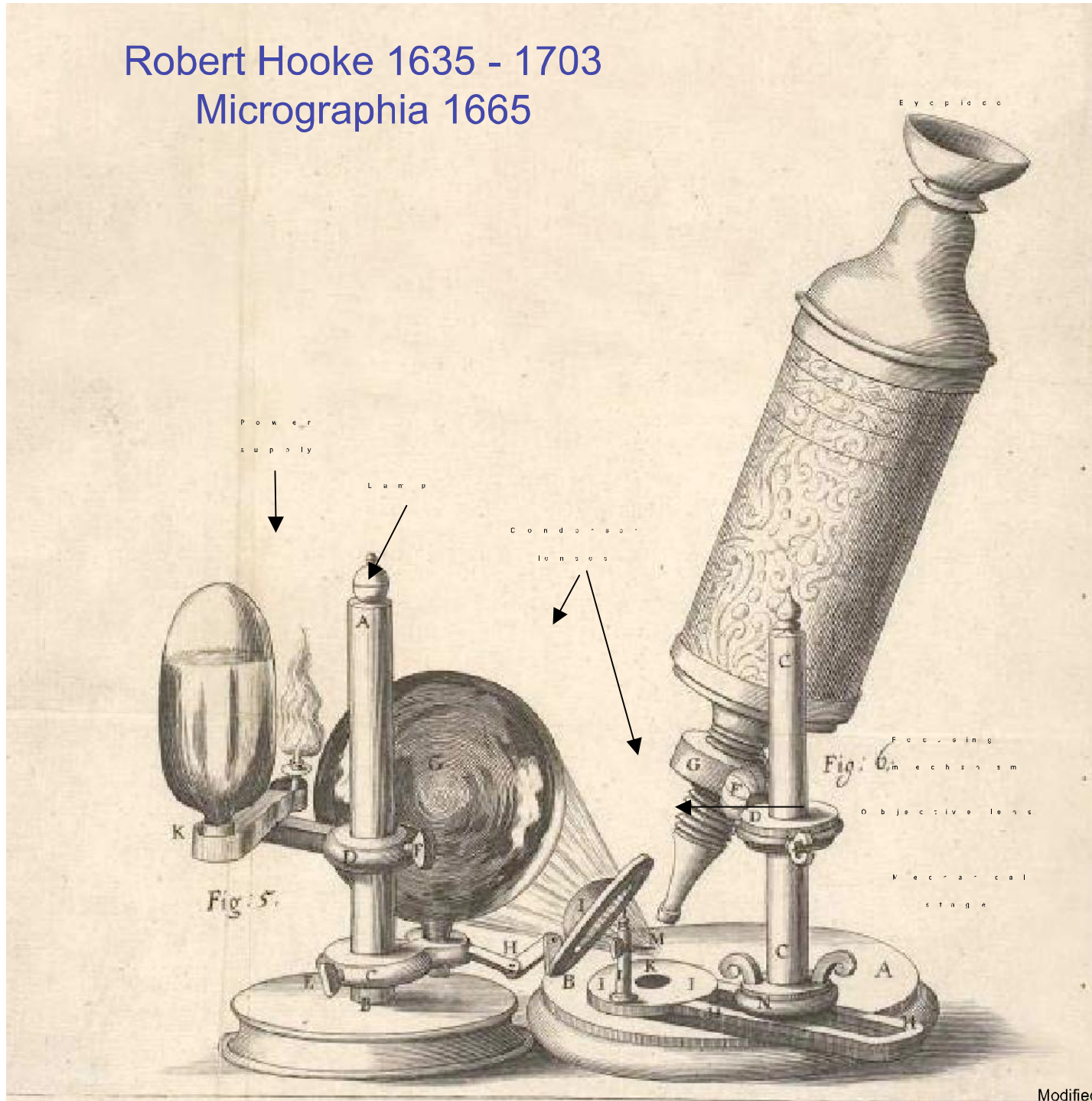

Fig: 2.



Robert Hooke 1635 - 1703
Micrographia 1665





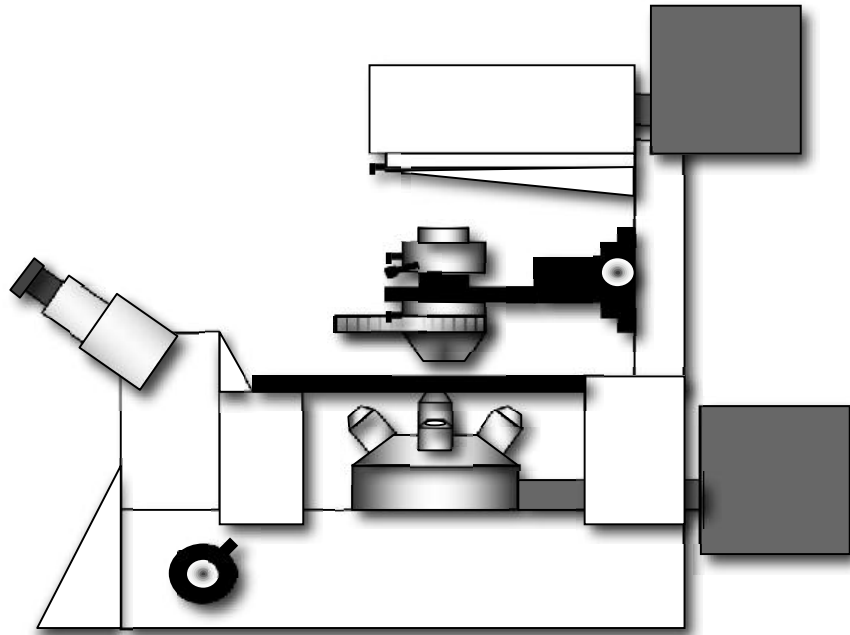

I N V E R T E D

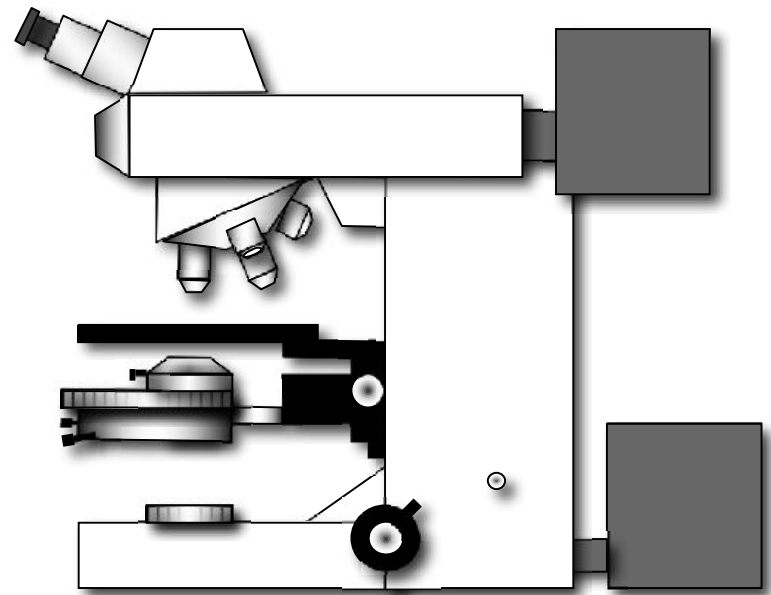

U P R I G H T

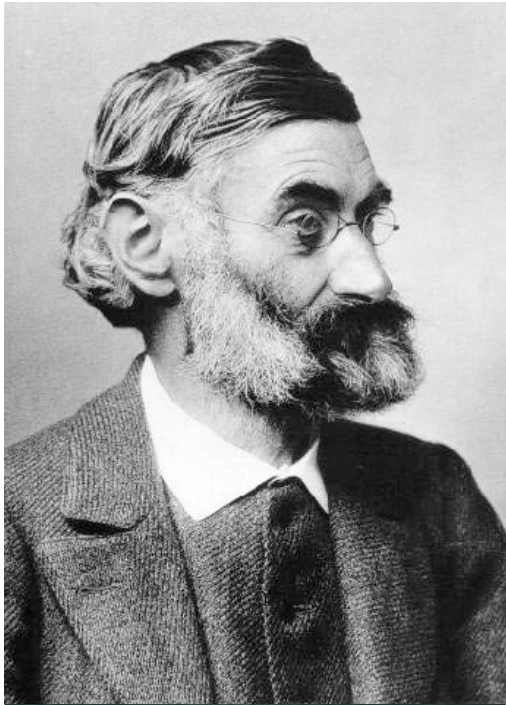

Ernst Abbe
1840 - 1905



Carl Zeiss
1816 - 1888



Otto Schott
(1851 - 1935)

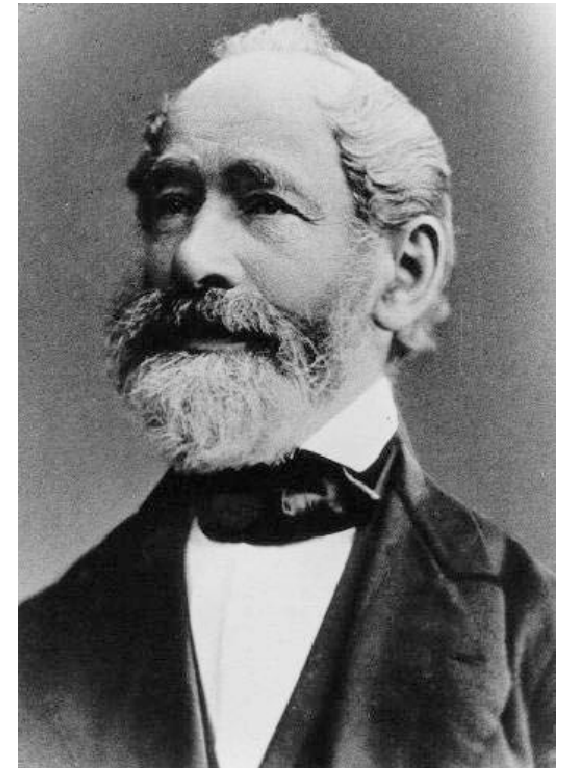



Carl Müller. Friedrich Pfaffe. Joseph Rudolph. Wilhelm Böber. Heinrich Pape. Fritz Müller. August Löber.

Optische Werkstatt von 1864.

Shapes and Principal Planes of Simple Lenses

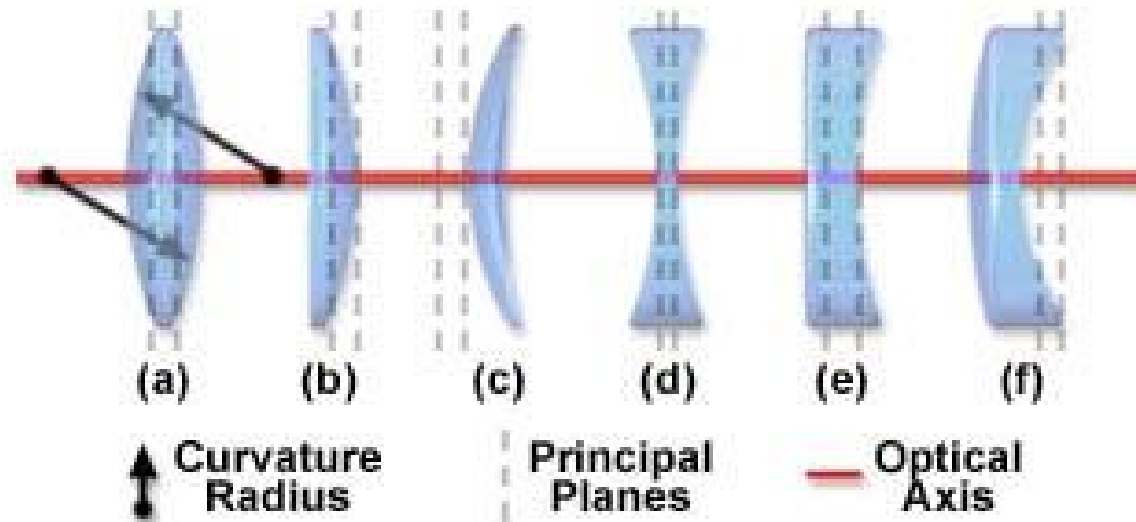

Uncommon Lens Geometries

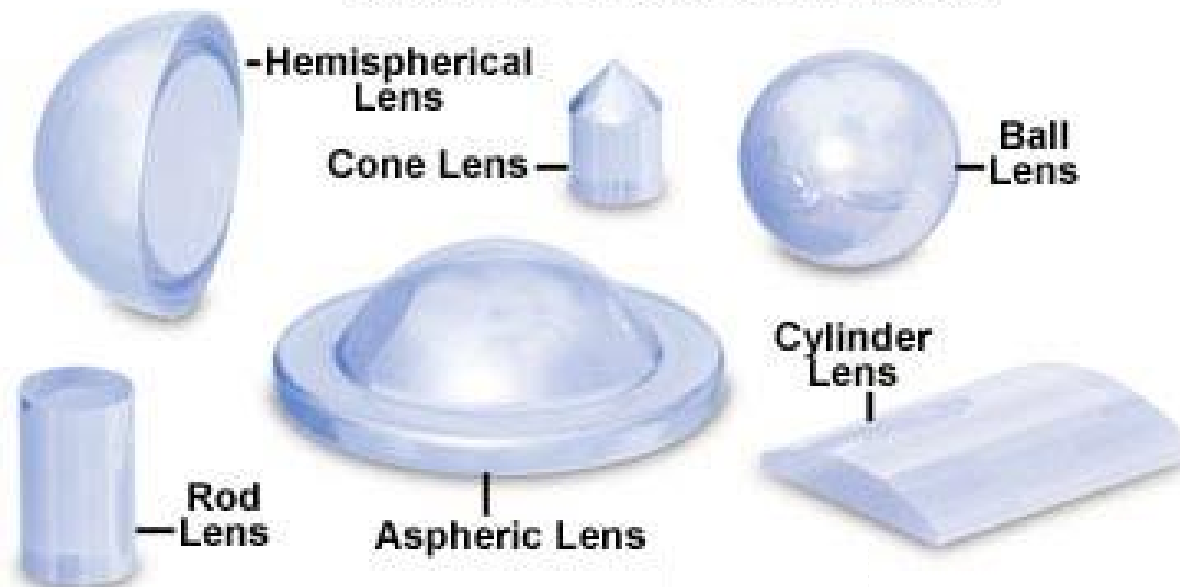

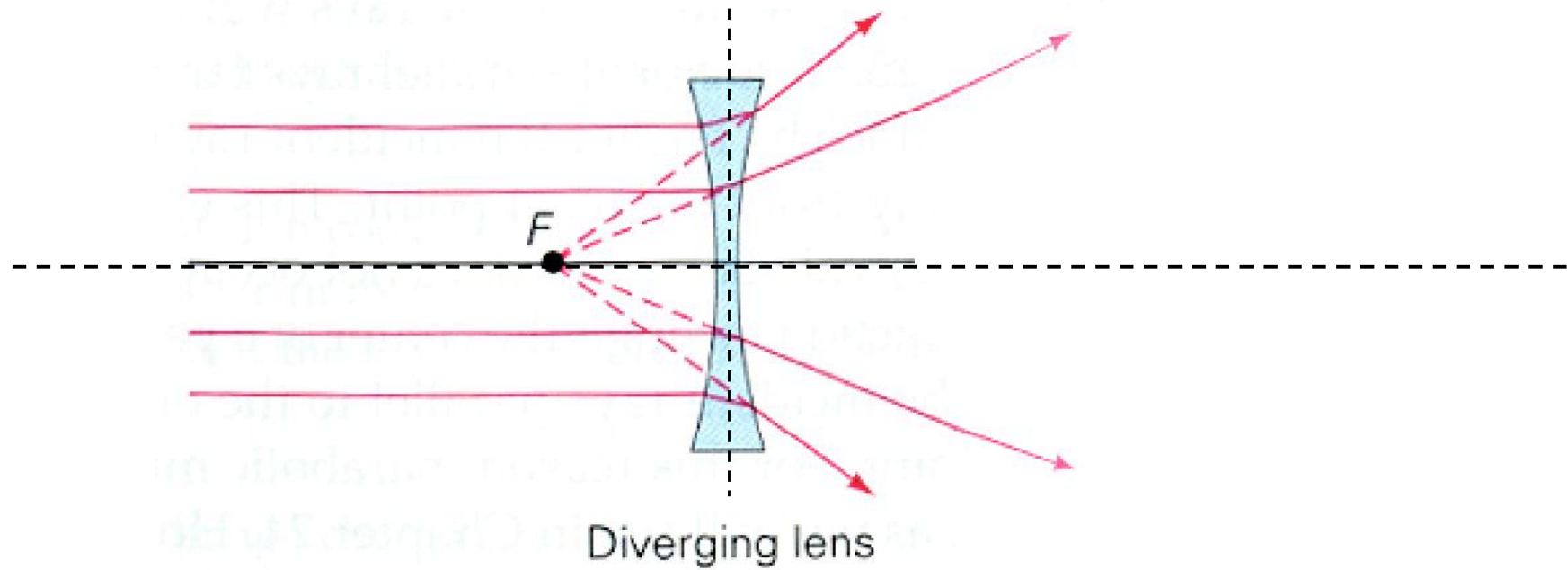
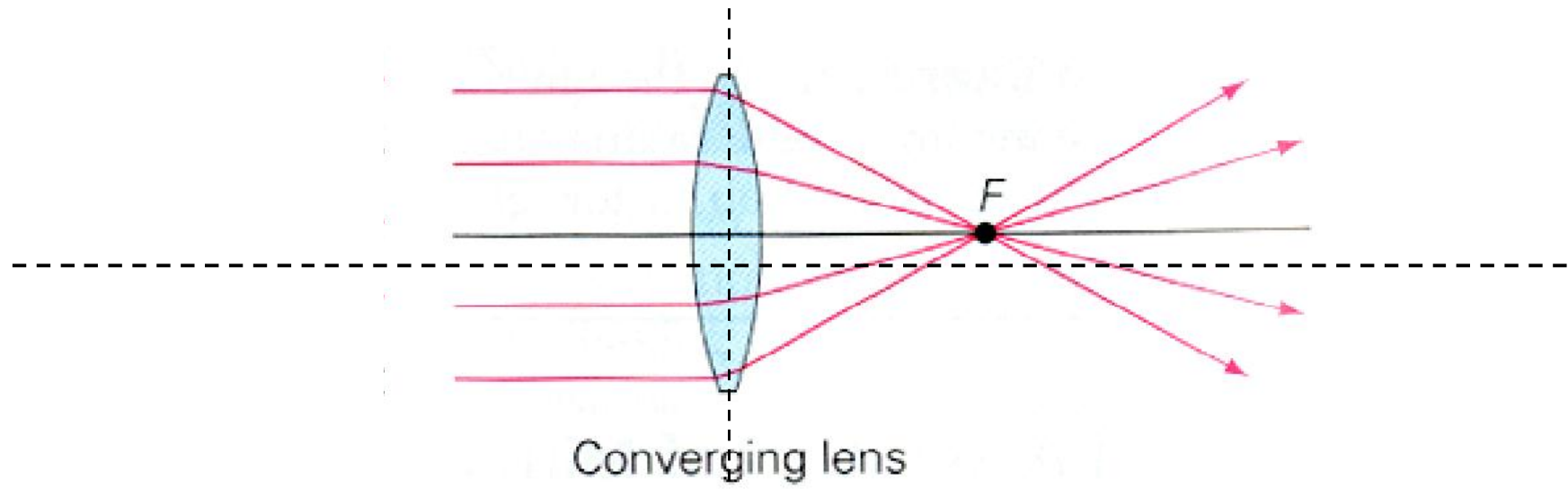

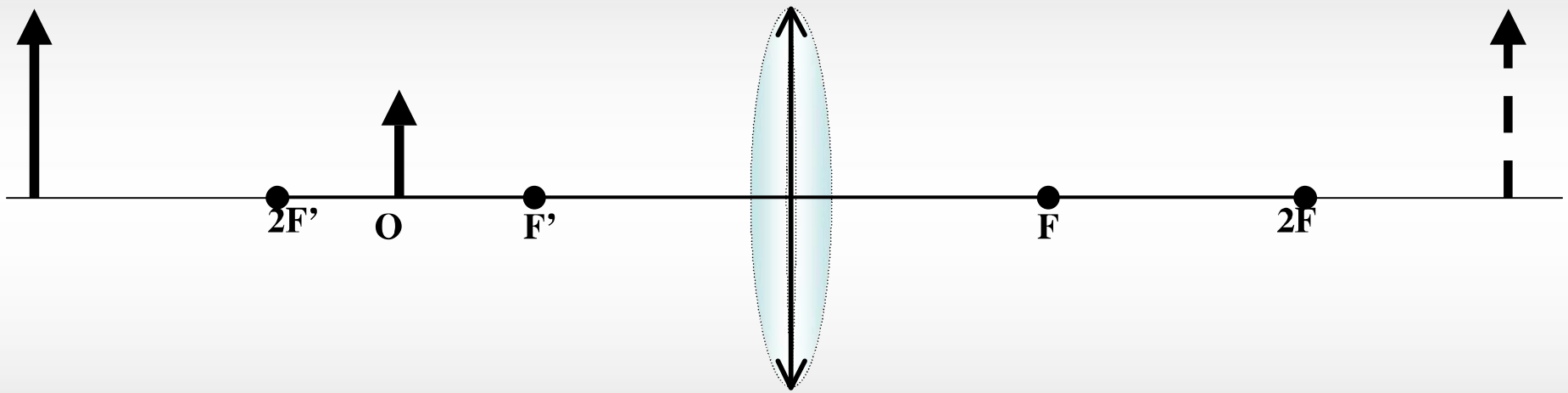

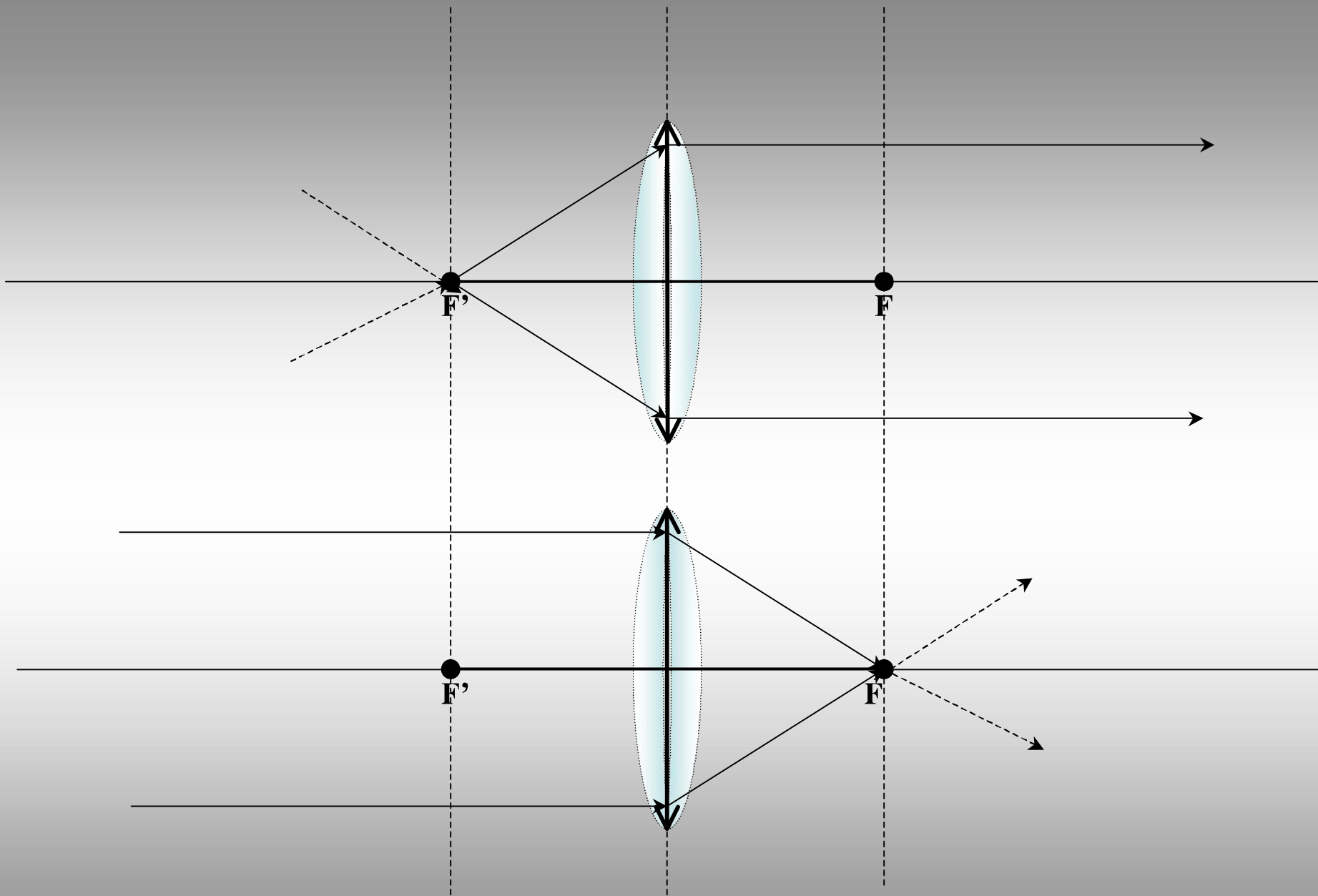

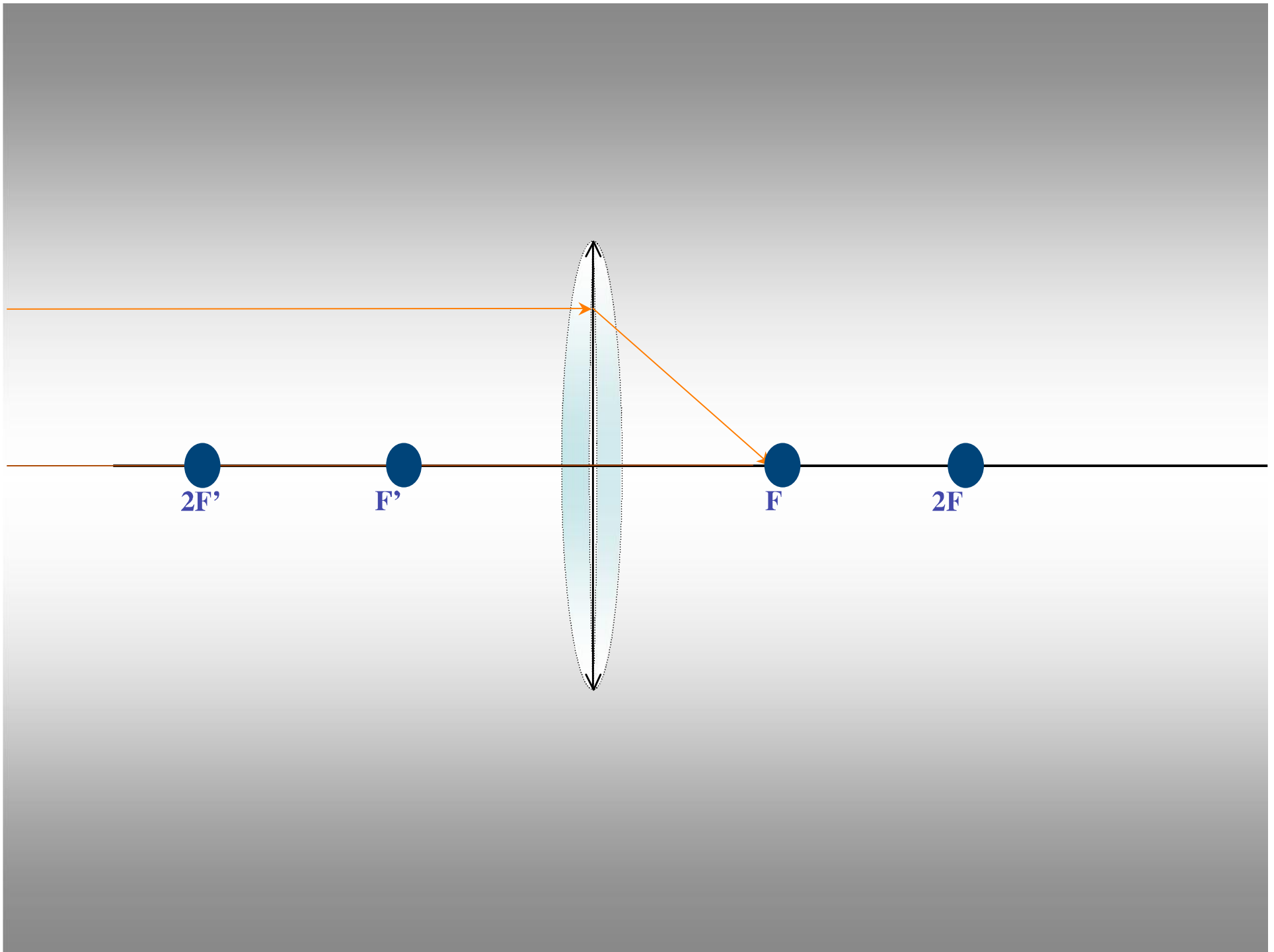

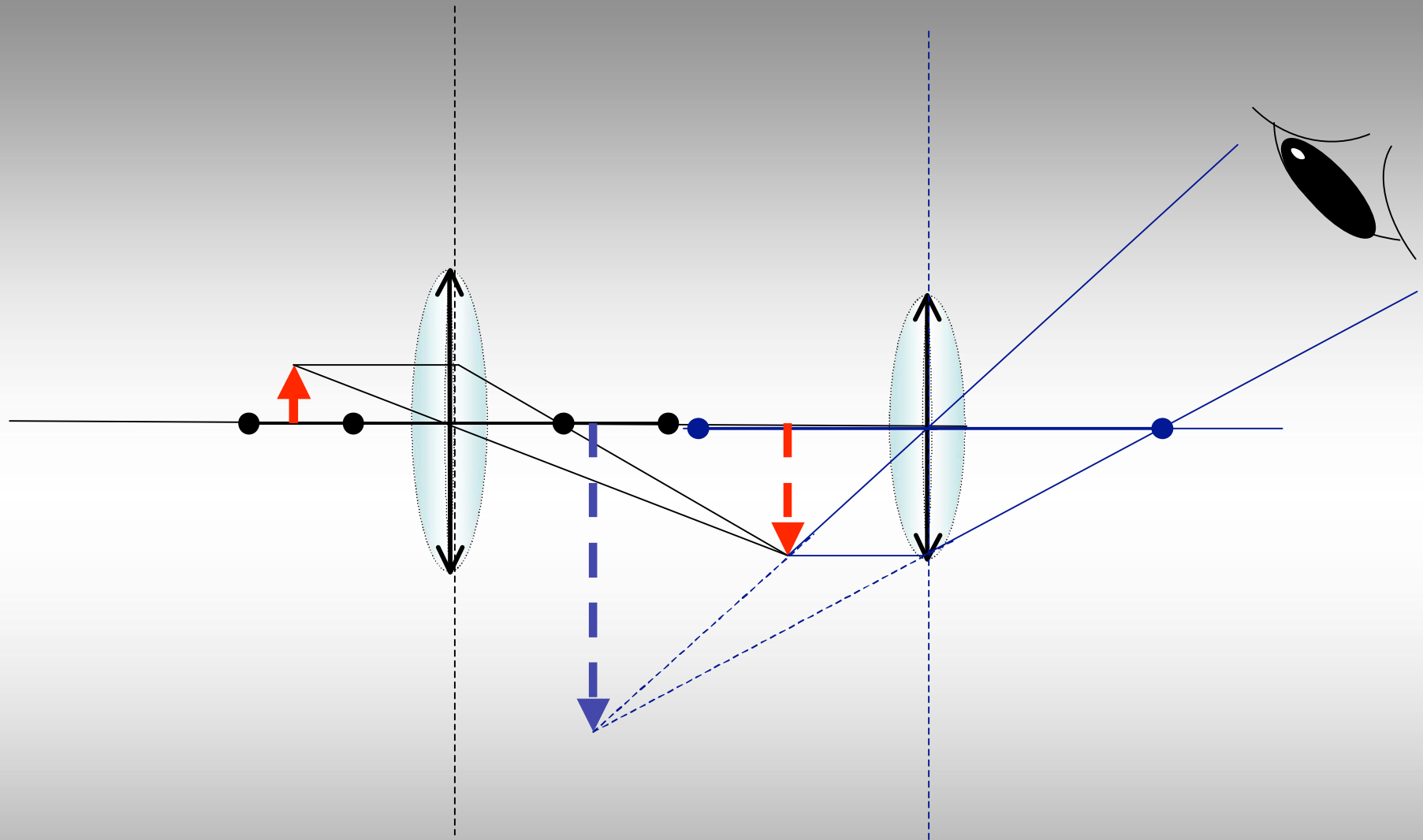

(a) Normal eye

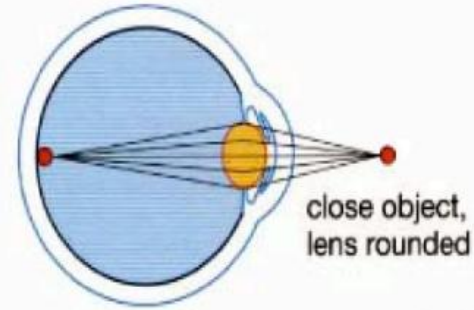
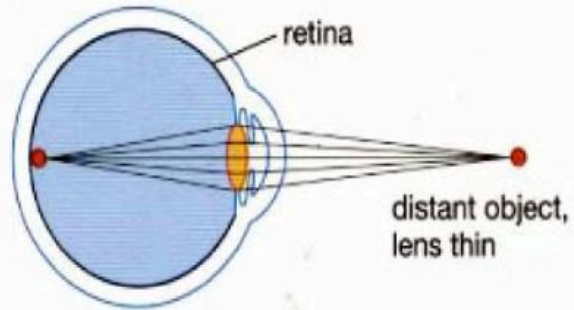

(b) Nearsighted eye (long eyeball)

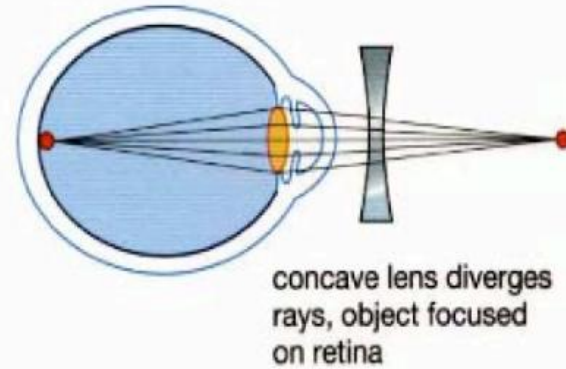
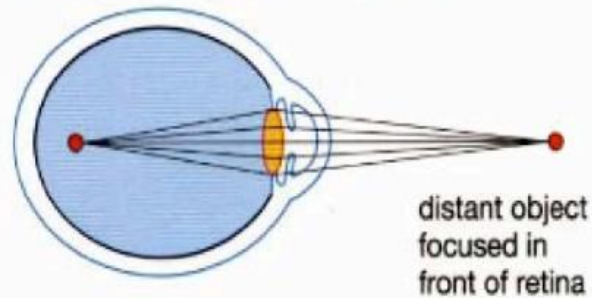

(c) Farsighted eye (short eyeball)

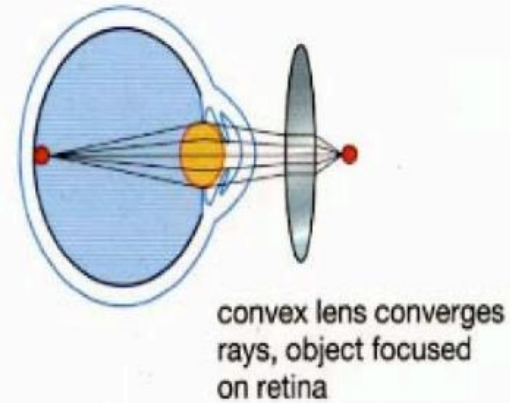
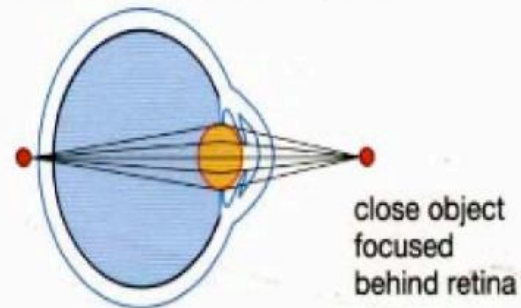

The lenses of the microscope

The important lenses of the microscope are *positive* or *converging* lenses,

- thicker in the middle than at their edges

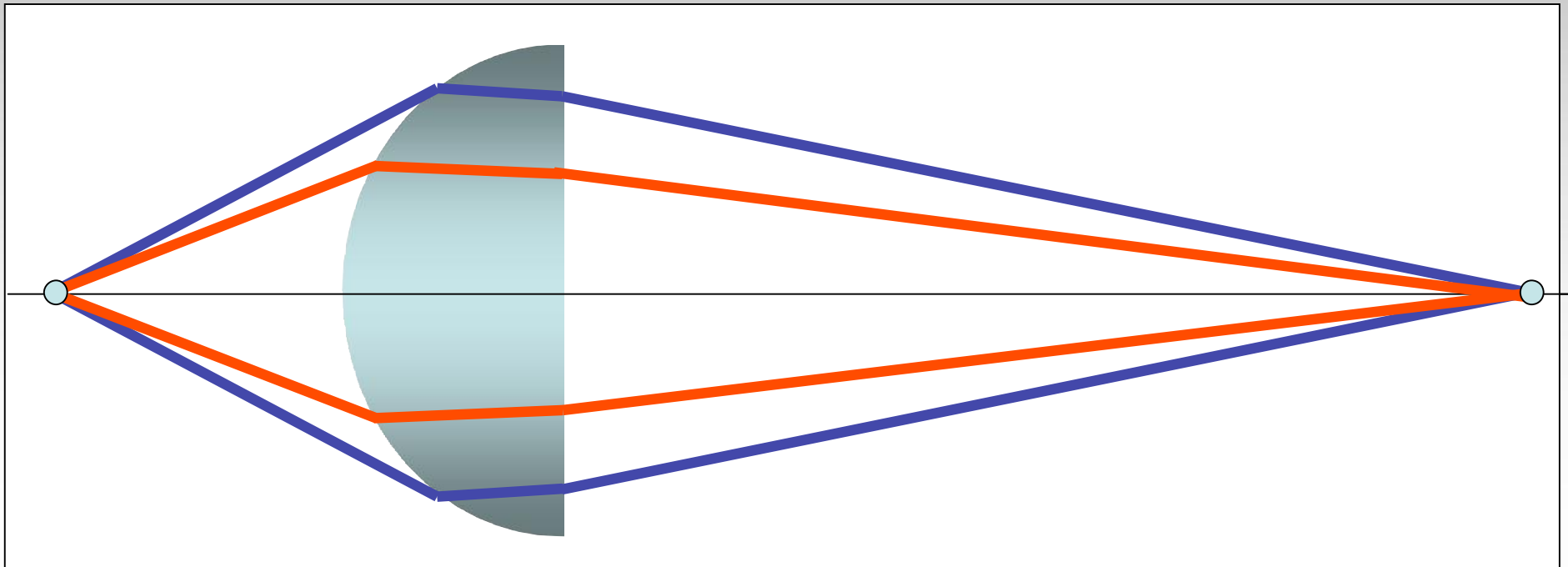

The job of an ideal lens

- To accept as many rays as possible from each point in an object
- To reassemble all the rays from each point at corresponding points in the image...
- In such a way that the distance travelled by all the rays from each object point to its corresponding image point is the same
 - so that they all arrive 'in phase'.

This is unfortunately not possible with a
single-element lens
because of several *aberrations*
- spherical, chromatic and others

Field Curvature Aberration

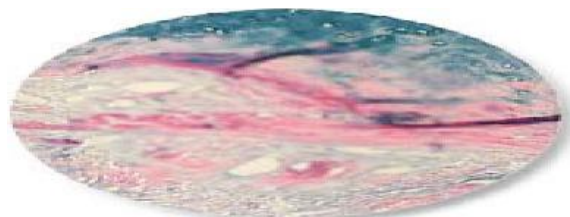
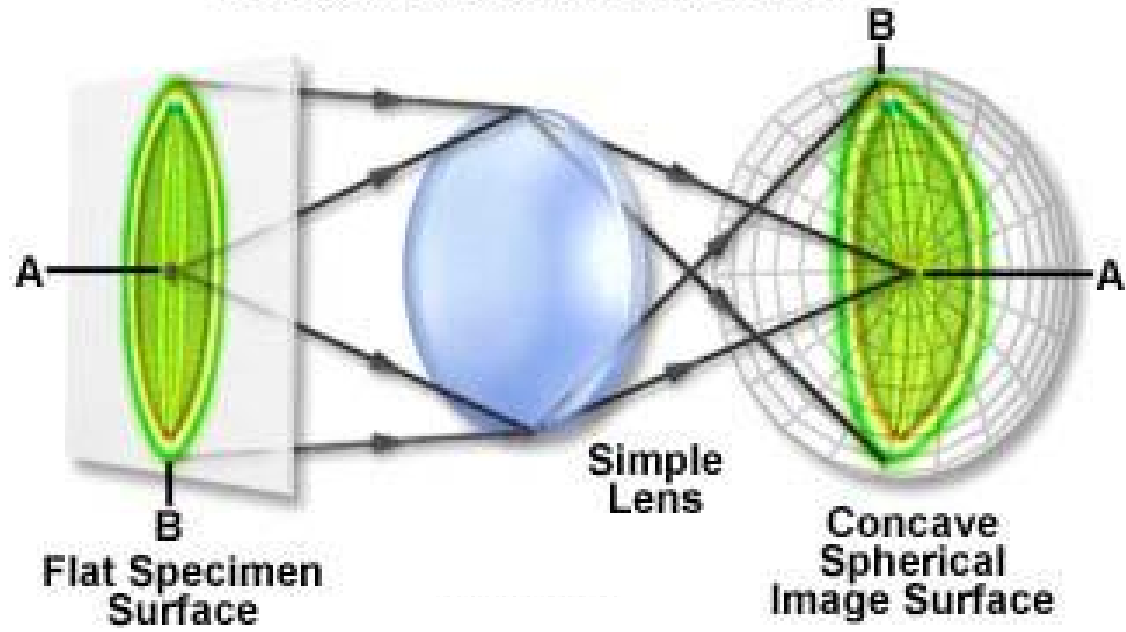

(a) Edges in Focus



(b) Entire Viewfield in Focus



(b) Entire Viewfield in Focus

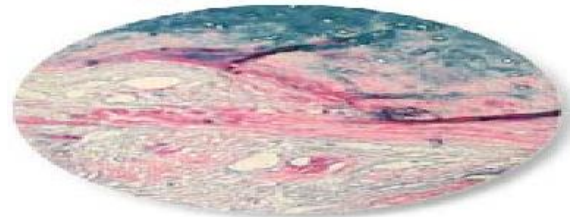

(b) Entire Viewfield in Focus

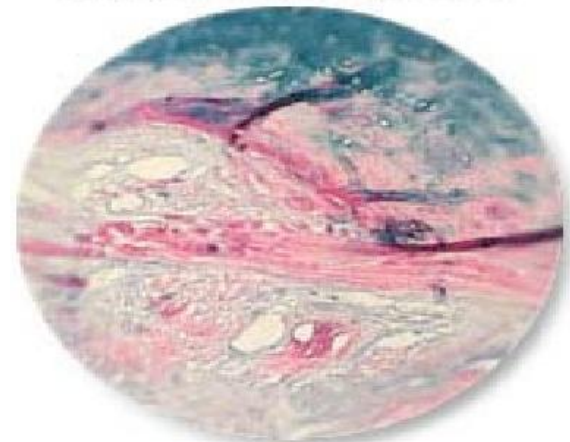
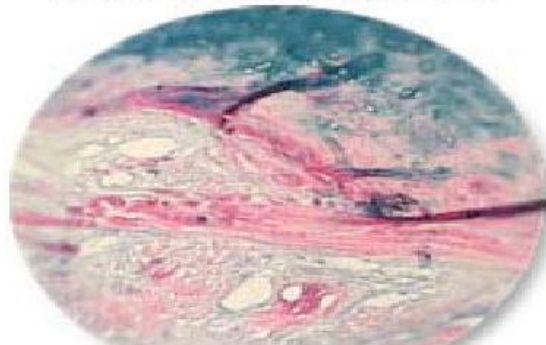

(c) Center in Focus

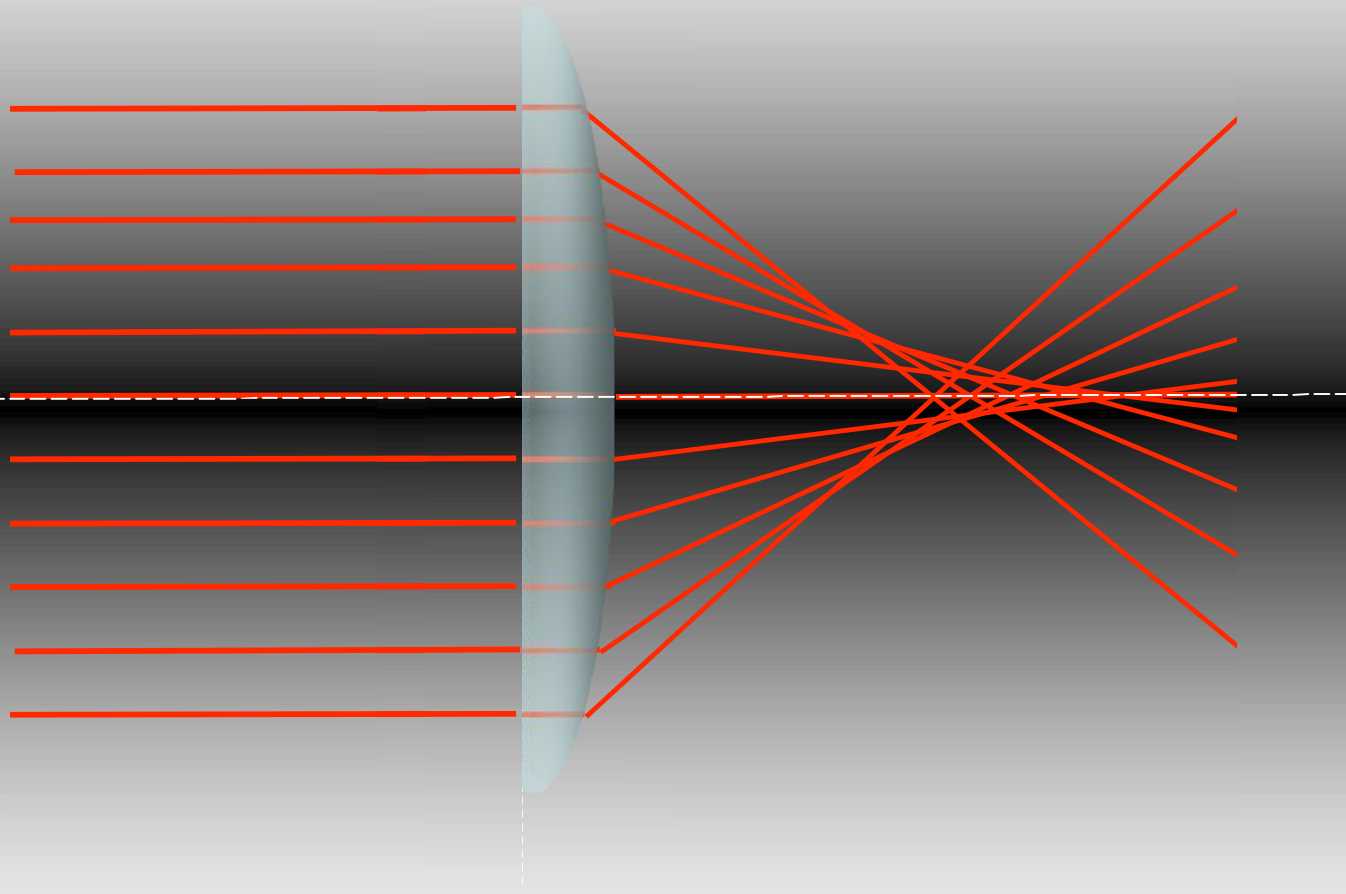

Spheric Aberration

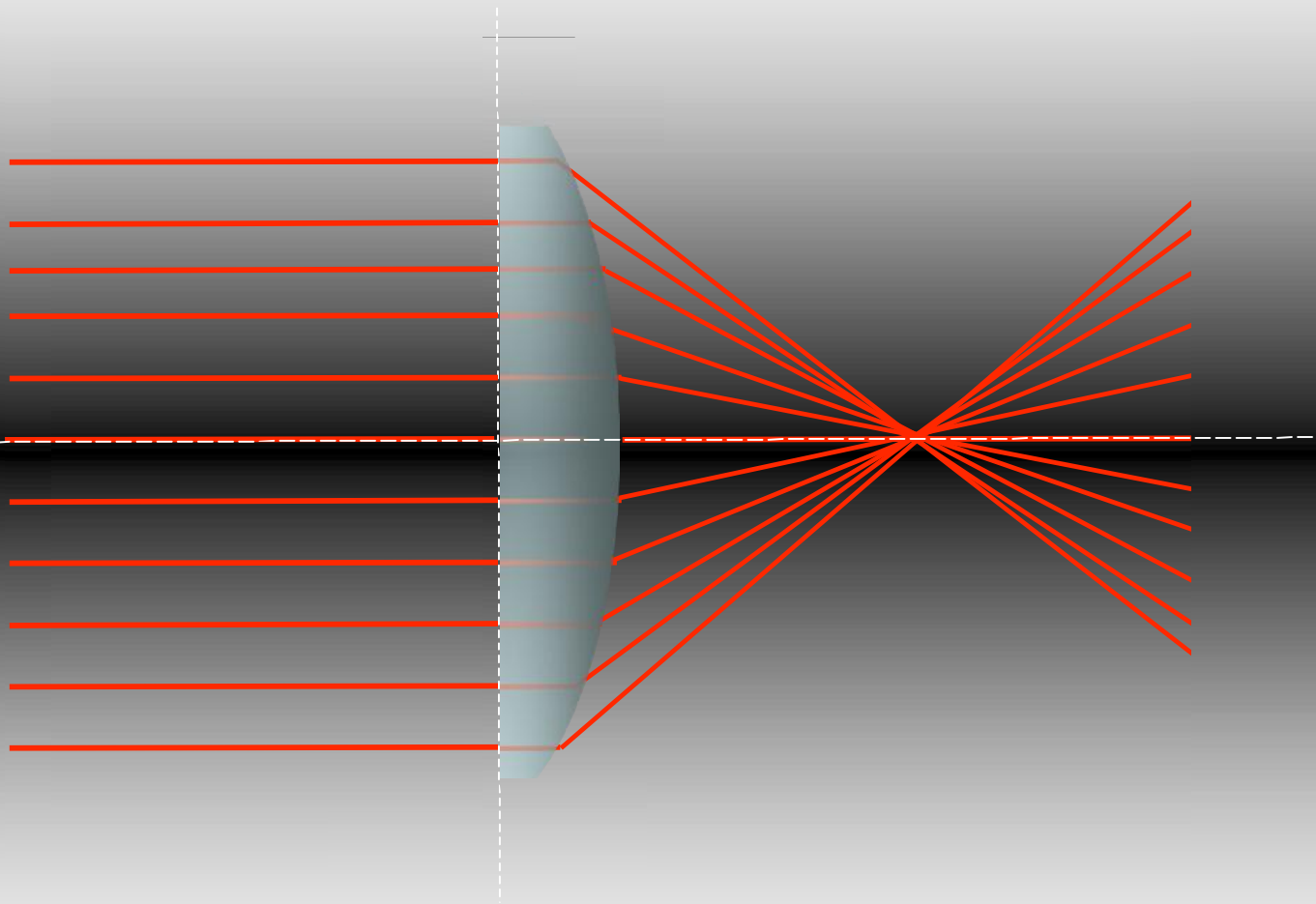

Spheric Aberration Correction

Spheric Aberration

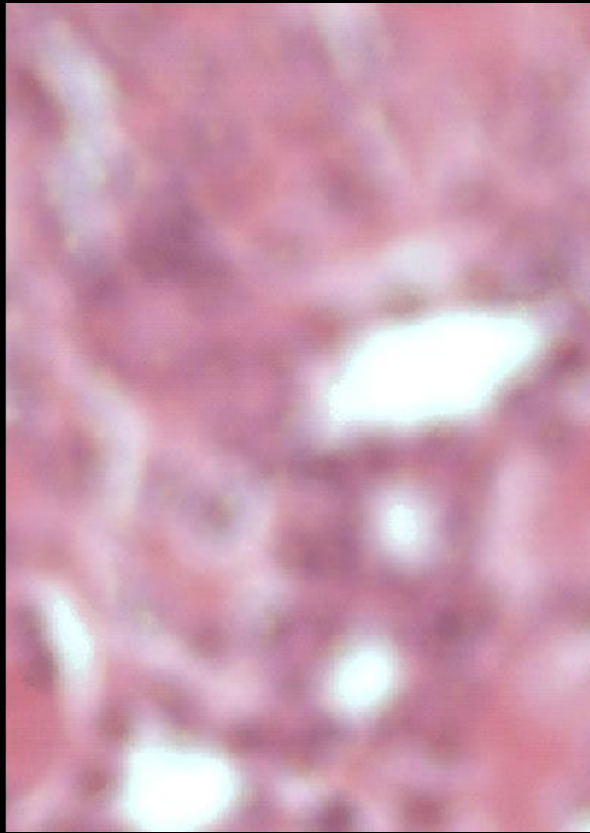

-5

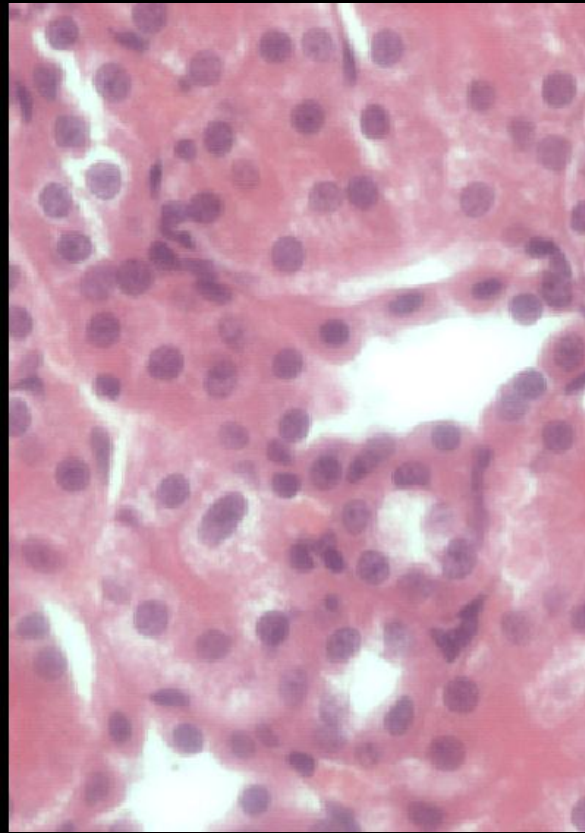
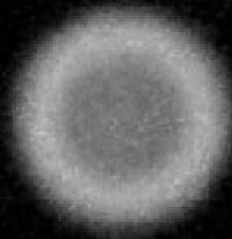

0

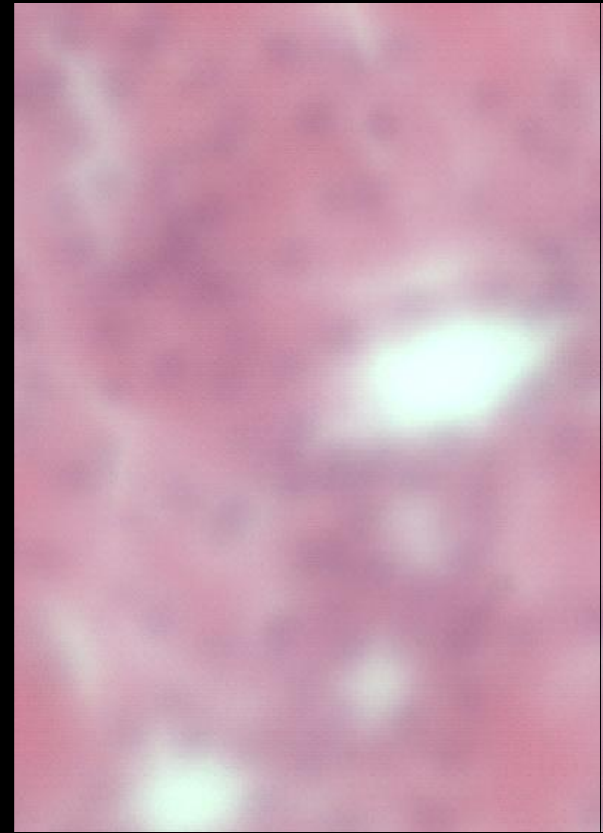

+5



CHROMATIC ABERRATION

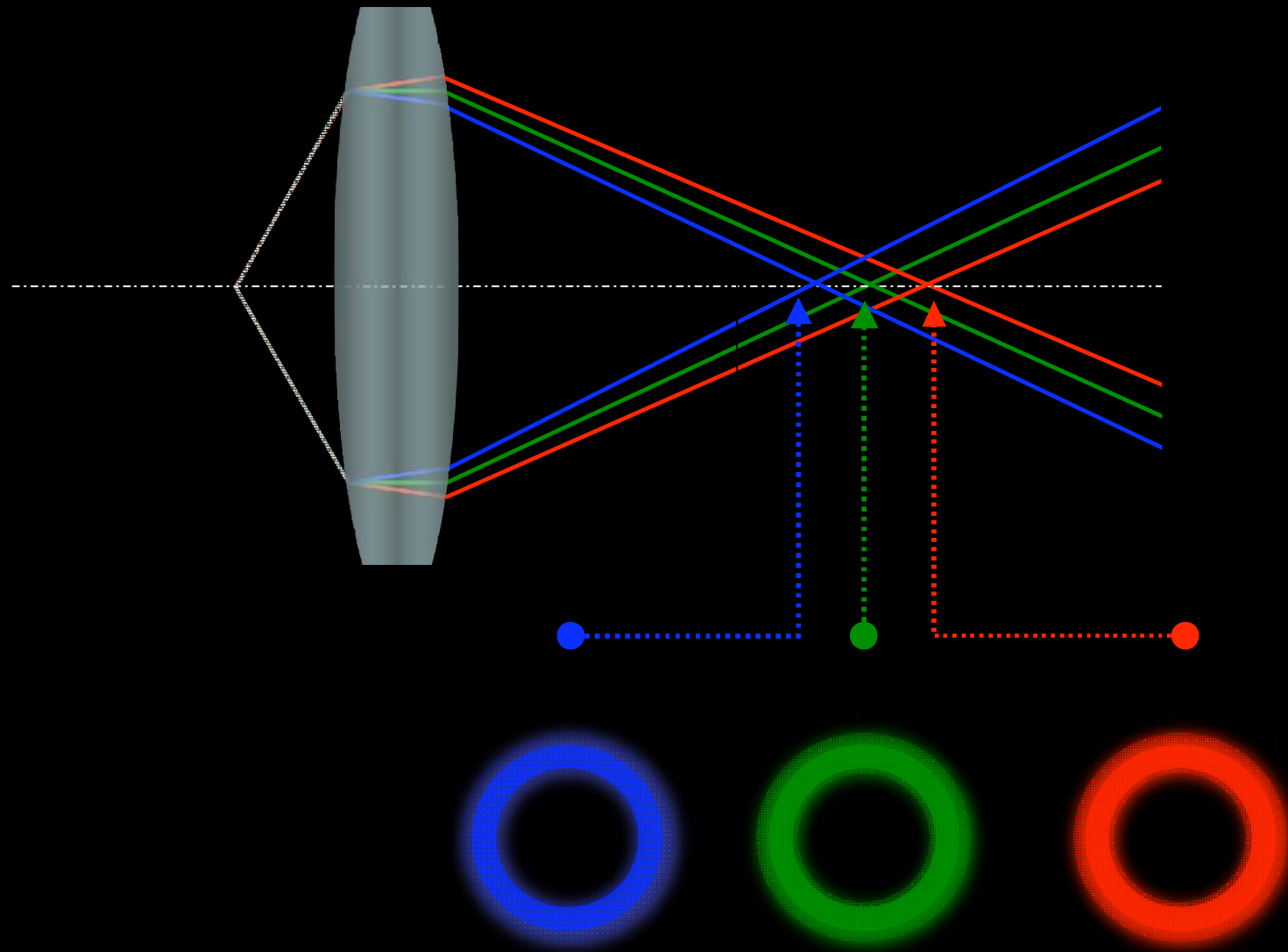

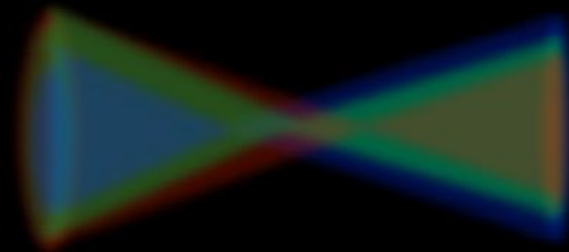
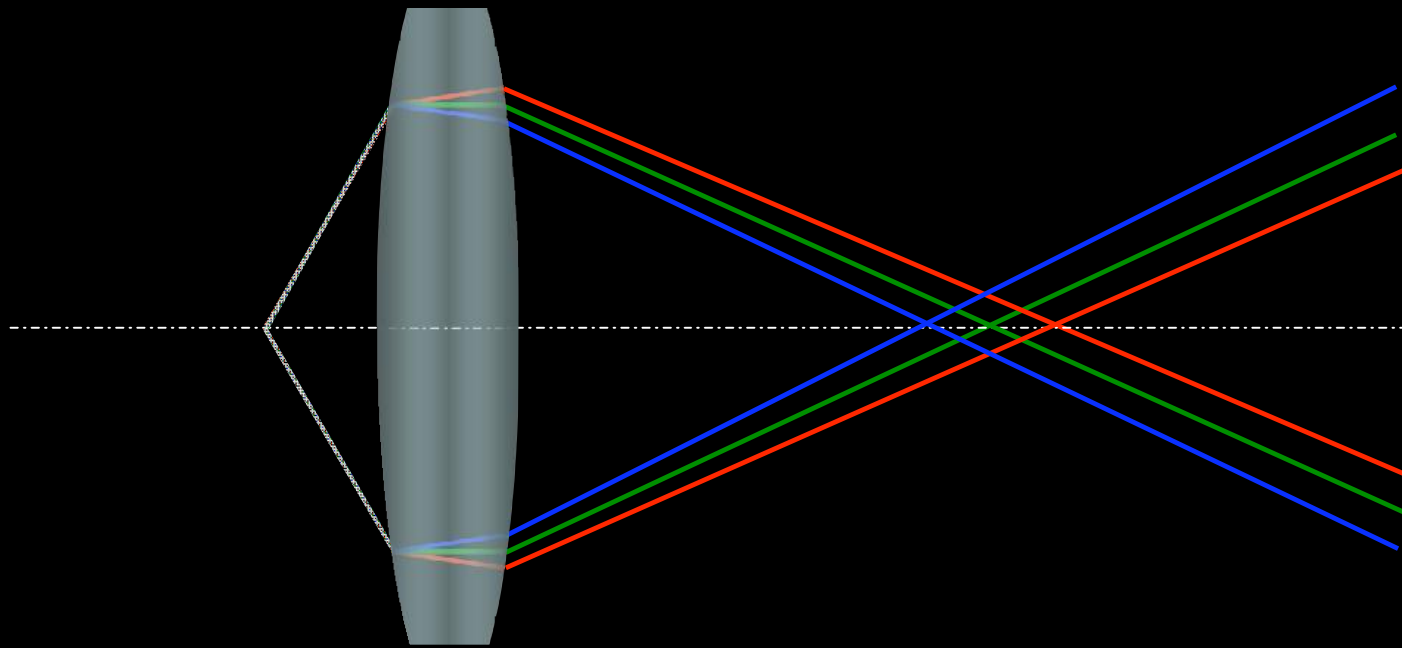

CHROMATIC ABERRATION

CHROMATIC ABERRATION CORRECTION

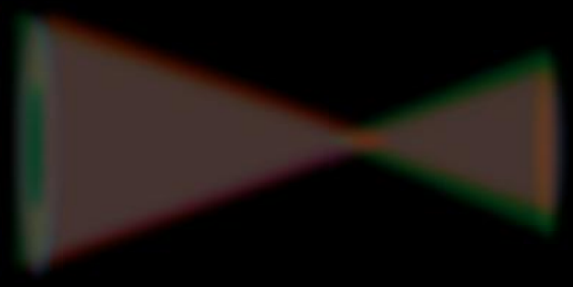
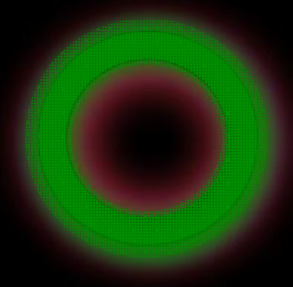
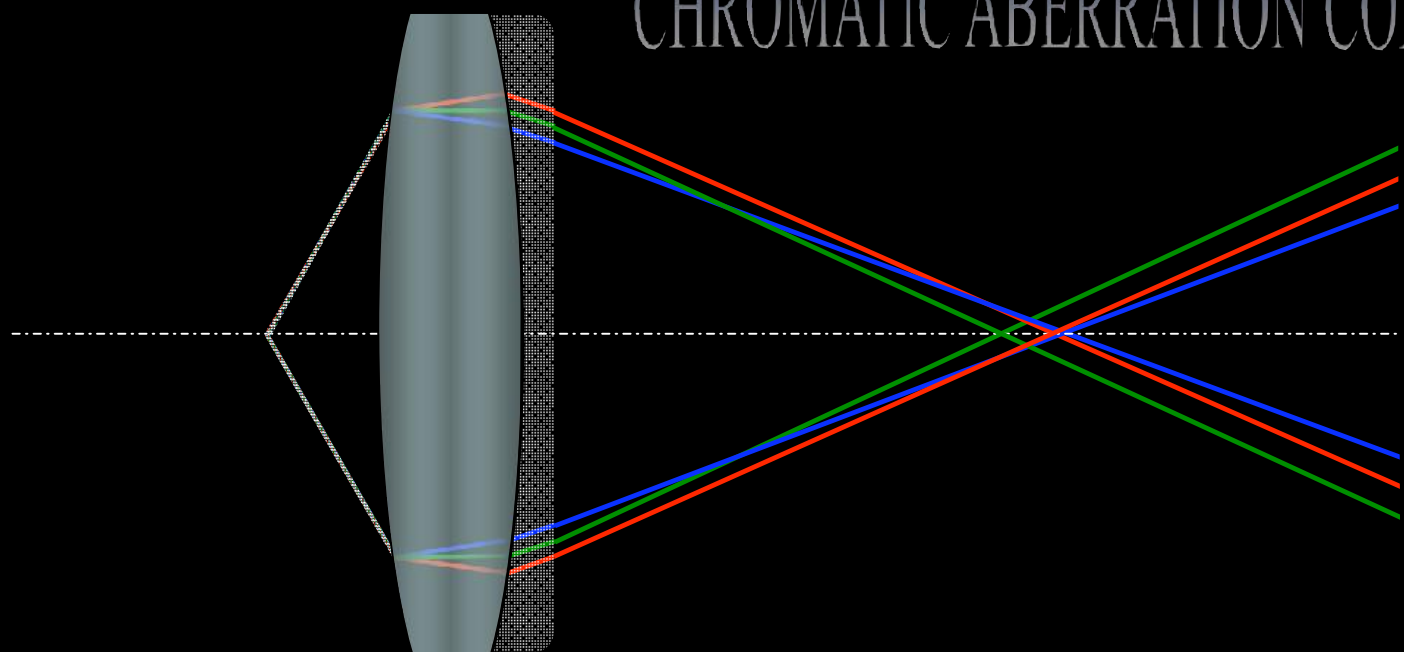

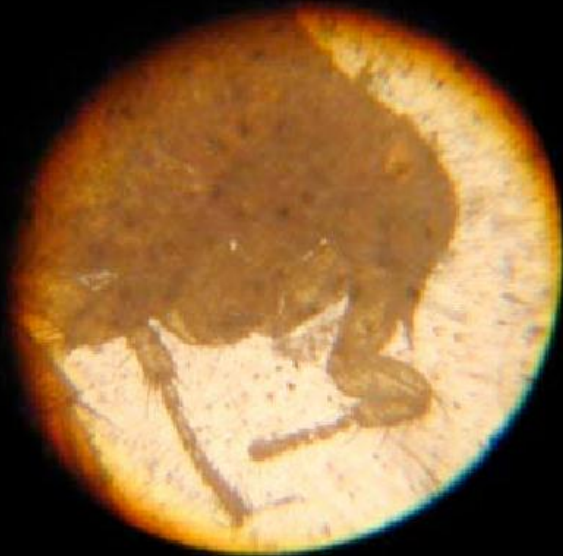
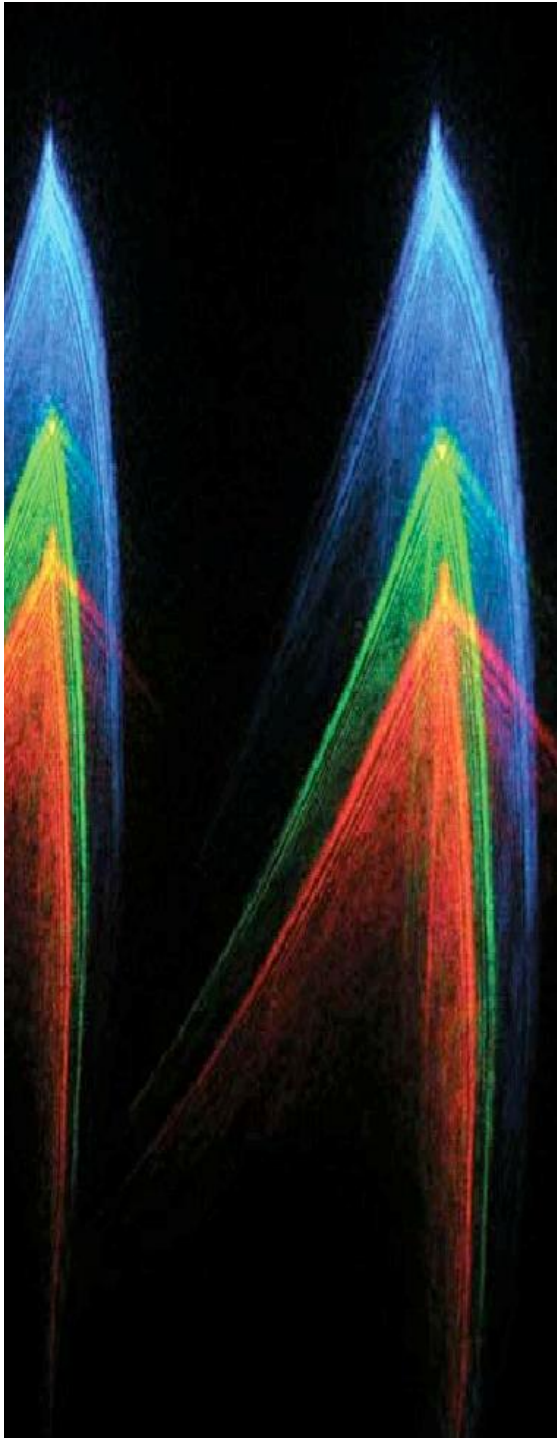

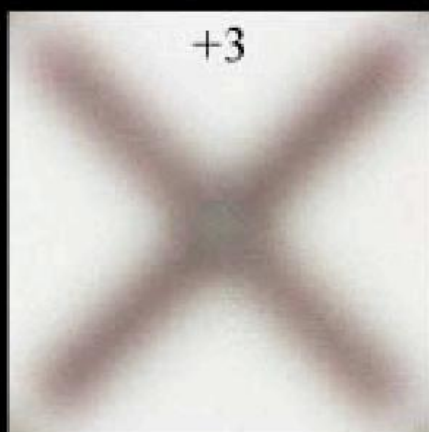
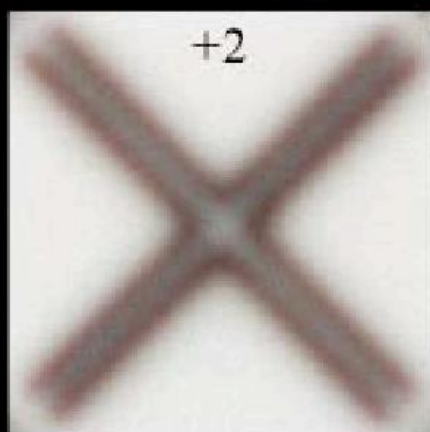
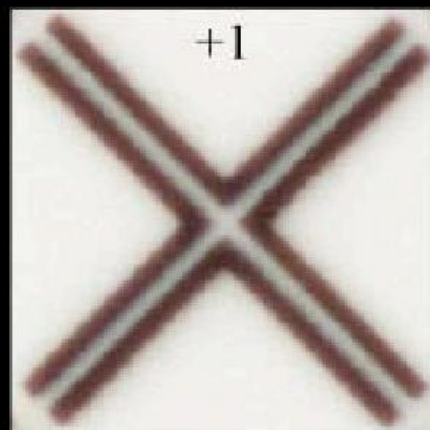
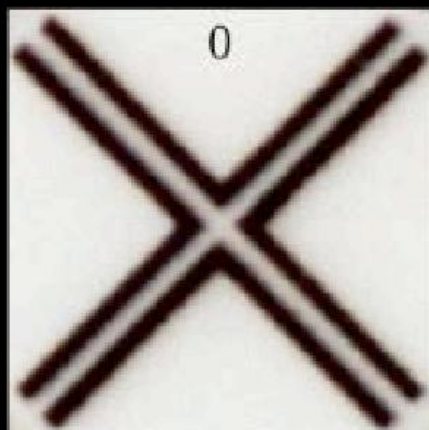
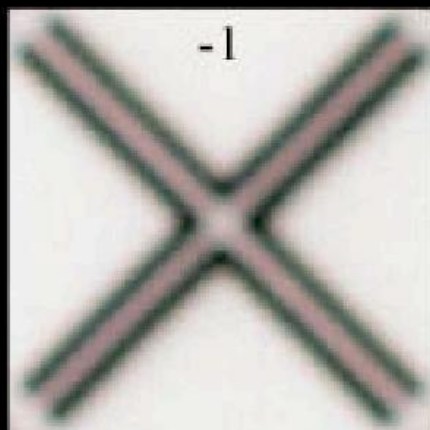
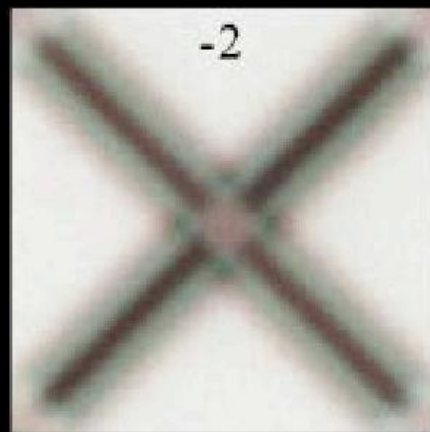
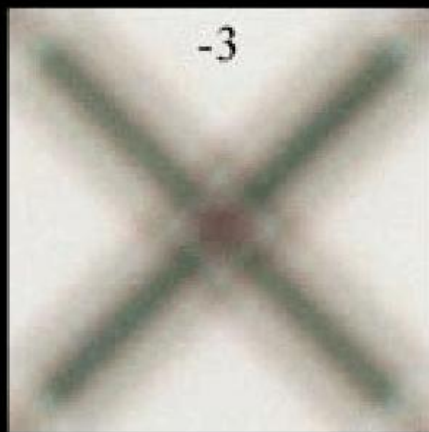
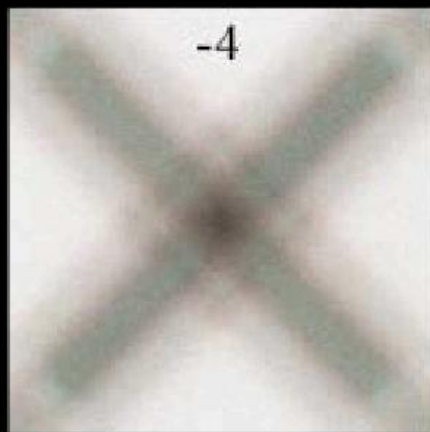

The objective lens

Is the microscope

The other parts support its function
and adapt the image
to the receiving device

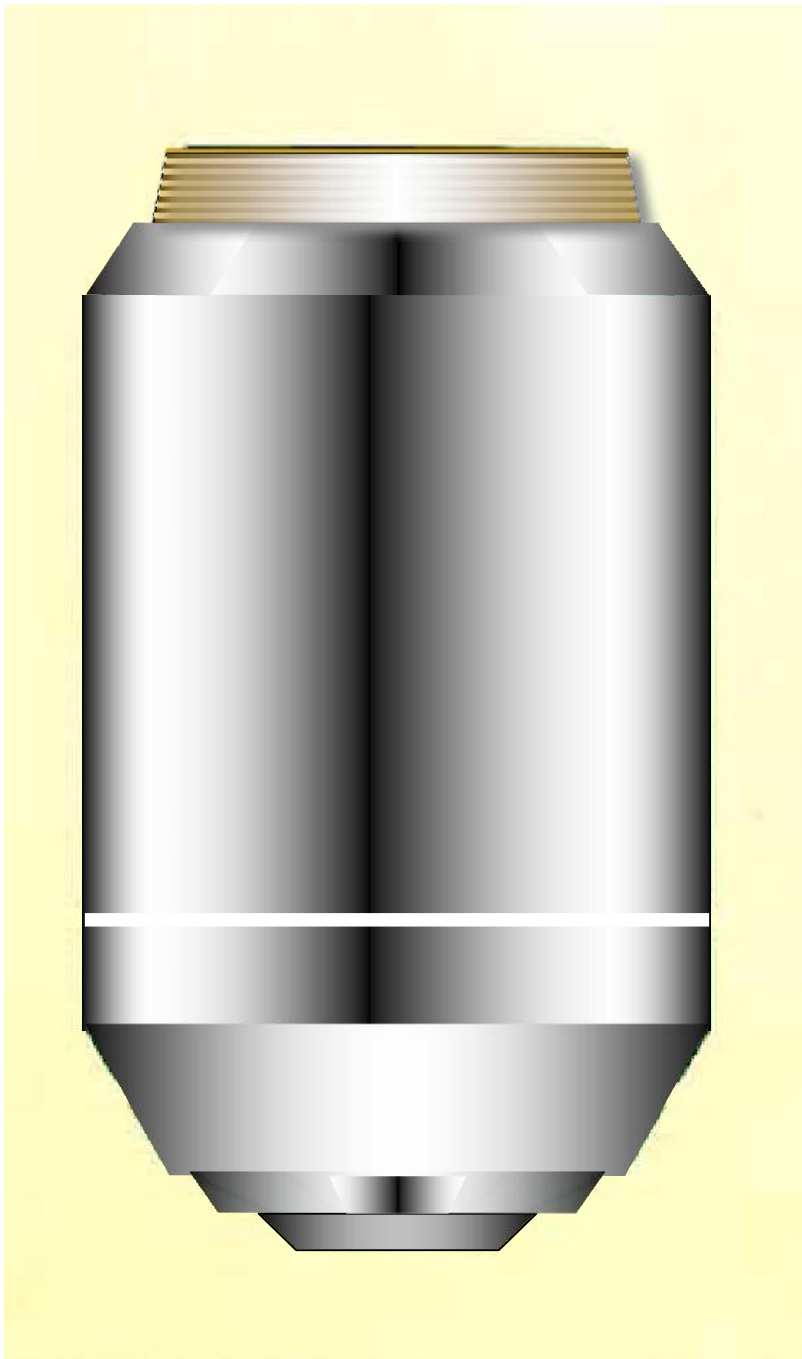

Objective Correction for Field Curvature

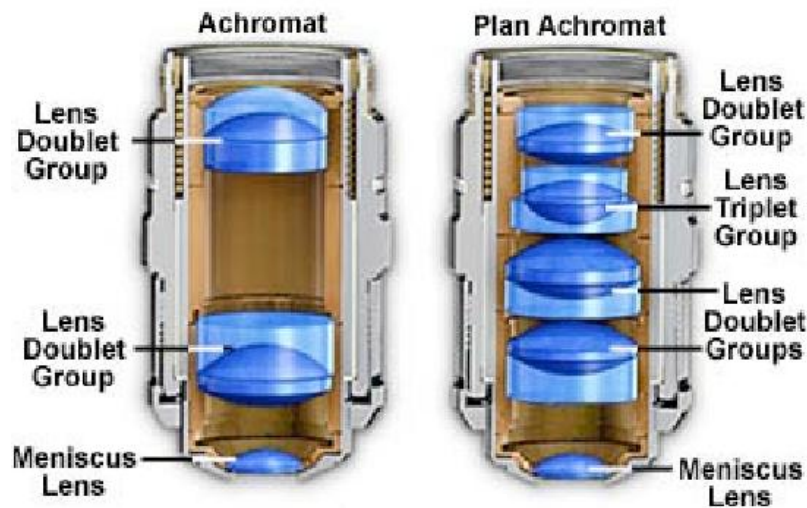

Common Objective Optical Correction Factors

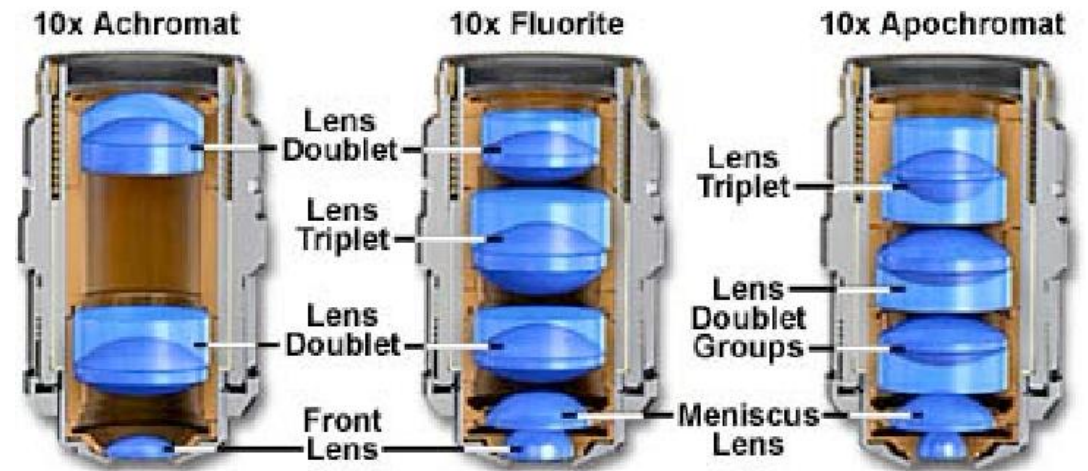

Objective Correction for Optical Aberration

Objective Type	Spherical Aberration	Chromatic Aberration	Field Curvature
Achromat	1 Color	2 Colors	No
Plan Achromat	1 Color	2 Colors	Yes
Fluorite	2-3 Colors	2-3 Colors	No
Plan Fluorite	3-4 Colors	2-4 Colors	Yes
Plan Apochromat	3-4 Colors	4-5 Colors	Yes

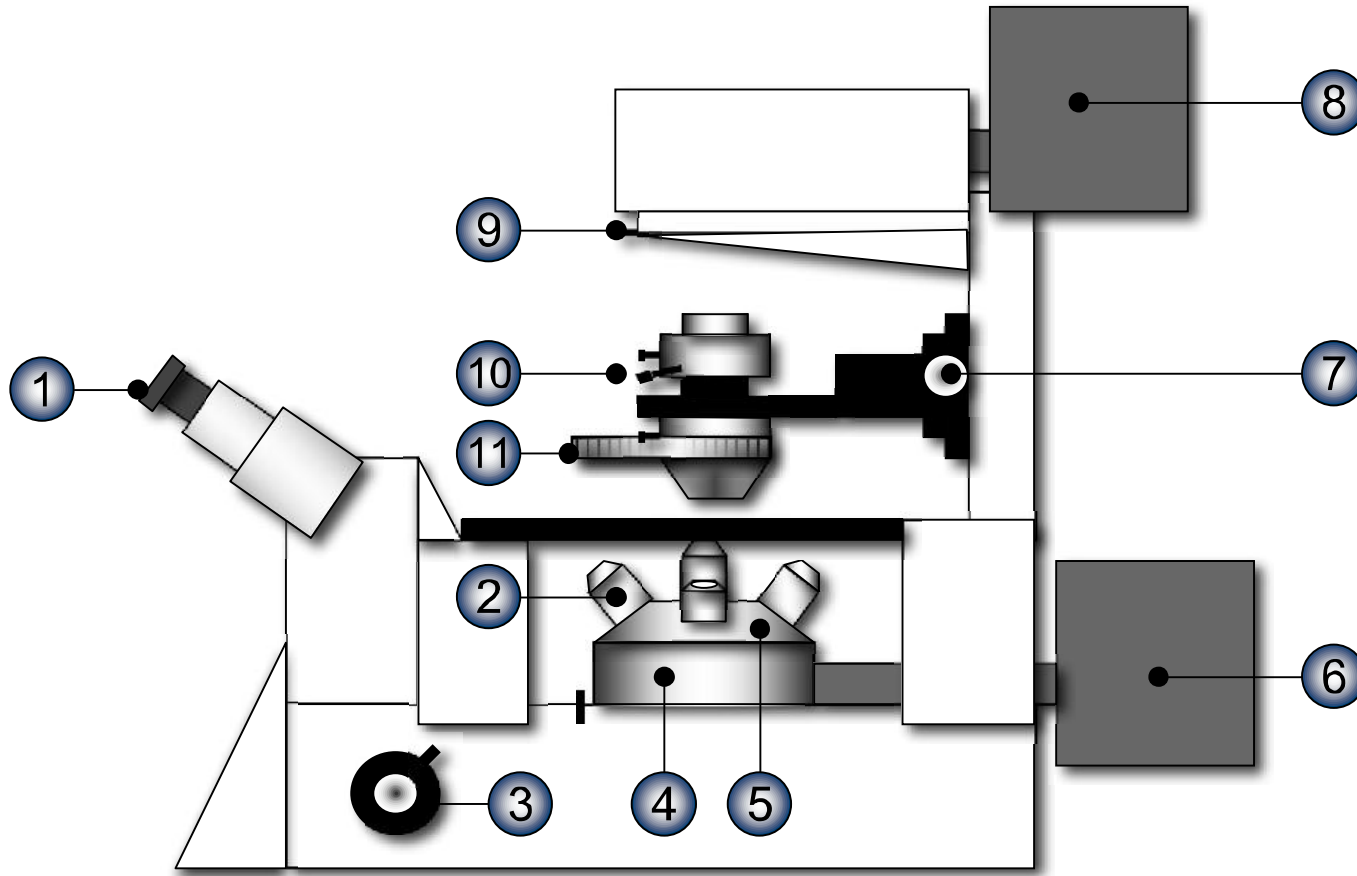

① Eyepieces

② Objectives

③ Focusing Knob

④ Filter wheel

⑤ Revolver

⑥ Lamp house (Halogen lamp)

⑦ Condenser adjusting knob

⑧ Lamp house (Mercury lamp)

⑨ Field Diaphragm

⑩ Condenser Diaphragm

⑪ Condenser

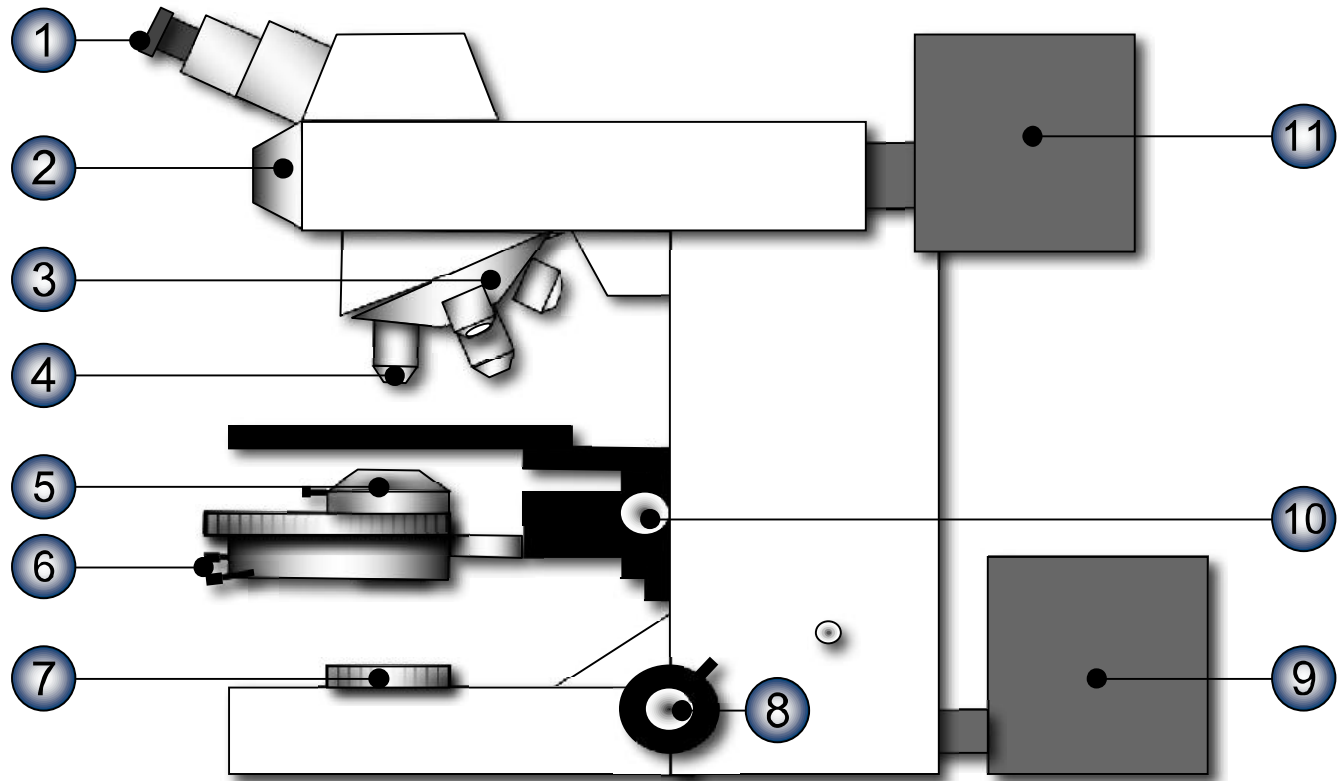

1 Eyepieces

2 Filter wheel

3 Revolver

4 Objectives

5 Condenser

6 Condenser Diaphragm

7 Field Diaphragm

8 Focusing Knob

9 Lamp house (Halogen lamp)

10 Condenser adjusting knob

11 Lamp house (Mercury lamp)

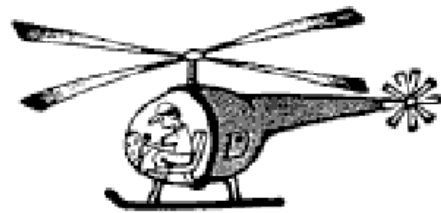

Lesser Magnification

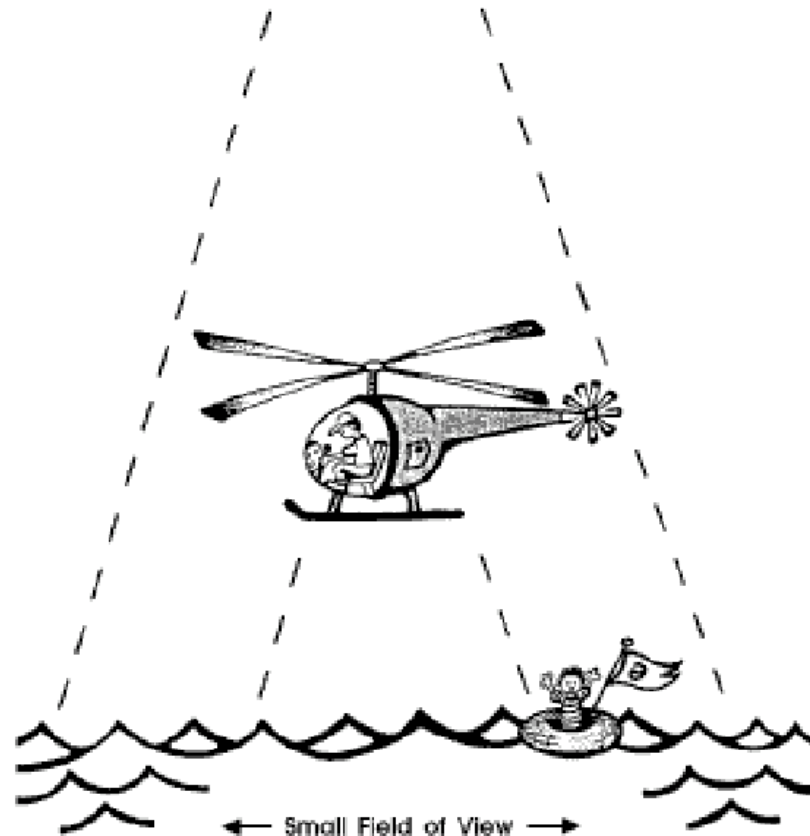

**Field Size Variations
with
Field Number**

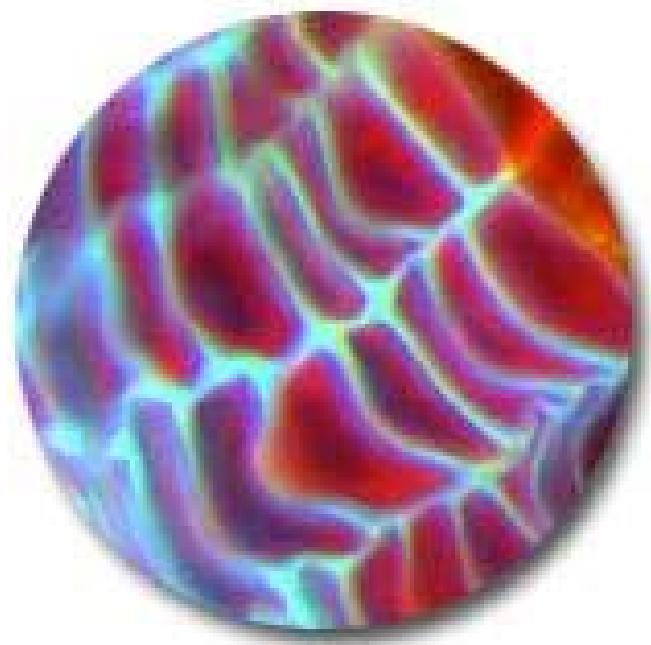

Field Number = 20

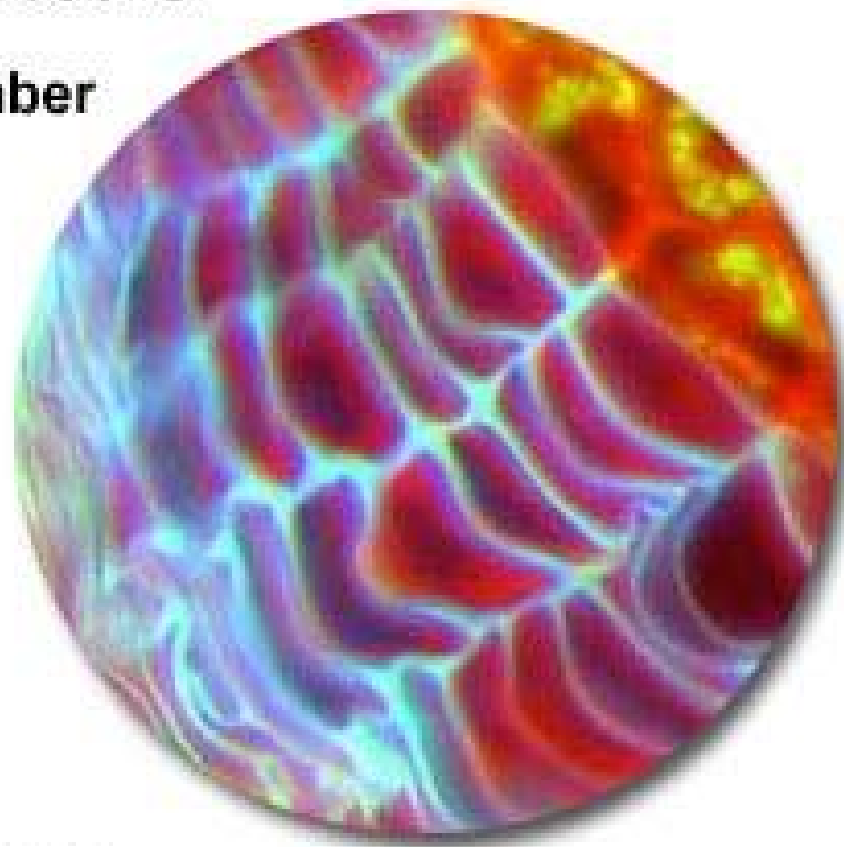

Field Number = 26

... in addition, the same figure of
... distance for that aperture. ...
... scales on a lens barrel
... hyperfocal distance opposite
... you are using. If you then
... the depth of field will
... ce to infinity. ◁ For
... camera has a hyperfo
... e focus at 18 feet,

Large
Depth of
Field
(small aperture)



Shallow
Depth of
Field
(large aperture)



